



LMI[®]

an Accudyne Industries brand

2018 Price List

July 2018

LMIPUMPS.COM

201 IVYLAND RD | IVYLAND, PA 18974 | info@lmipumps.com

For complete product documentation
please visit:

support.lmipumps.com



From there, you can quickly access:

- The latest product manuals and technical documentation
- Sales brochures and promotional material
- Certification and engineering files

Search by keyword, product series, or model number

Filter by document type, product, and language

Download to your computer, tablet, or phone for offline access

SECTION I - ELECTRONIC METERING PUMPS, PARTS, & ACCESSORIES		Page																																																																											
Minimum Advertised Price Policy		4																																																																											
Chemical Resistance Guide		5																																																																											
Series PD		11																																																																											
<table border="1"> <thead> <tr> <th>Model</th> <th colspan="2">Max Output</th> <th colspan="2">Max Pressure</th> </tr> <tr> <th></th> <th>GPH</th> <th>l/h</th> <th>PSI</th> <th>Bar</th> </tr> </thead> <tbody> <tr> <td colspan="5">Series PD with FASTPRIME™</td> </tr> <tr> <td>PDx1</td> <td>0.25</td> <td>0.95</td> <td>450</td> <td>30.6</td> </tr> <tr> <td>PDx4</td> <td>0.68</td> <td>2.60</td> <td>250</td> <td>17</td> </tr> <tr> <td>PDx5</td> <td>1.10</td> <td>4.20</td> <td>150</td> <td>10.2</td> </tr> <tr> <td>PDx6</td> <td>2.00</td> <td>7.60</td> <td>70</td> <td>4.8</td> </tr> <tr> <td colspan="5">Series PD with AUTOPRIME™</td> </tr> <tr> <td>PDx4</td> <td>0.20</td> <td>0.76</td> <td>250</td> <td>17</td> </tr> <tr> <td>PDx5</td> <td>0.75</td> <td>2.84</td> <td>110</td> <td>7.5</td> </tr> <tr> <td>PDx6</td> <td>1.75</td> <td>6.62</td> <td>50</td> <td>3.4</td> </tr> </tbody> </table>	Model	Max Output		Max Pressure			GPH	l/h	PSI	Bar	Series PD with FASTPRIME™					PDx1	0.25	0.95	450	30.6	PDx4	0.68	2.60	250	17	PDx5	1.10	4.20	150	10.2	PDx6	2.00	7.60	70	4.8	Series PD with AUTOPRIME™					PDx4	0.20	0.76	250	17	PDx5	0.75	2.84	110	7.5	PDx6	1.75	6.62	50	3.4																						
Model	Max Output		Max Pressure																																																																										
	GPH	l/h	PSI	Bar																																																																									
Series PD with FASTPRIME™																																																																													
PDx1	0.25	0.95	450	30.6																																																																									
PDx4	0.68	2.60	250	17																																																																									
PDx5	1.10	4.20	150	10.2																																																																									
PDx6	2.00	7.60	70	4.8																																																																									
Series PD with AUTOPRIME™																																																																													
PDx4	0.20	0.76	250	17																																																																									
PDx5	0.75	2.84	110	7.5																																																																									
PDx6	1.75	6.62	50	3.4																																																																									
EXCEL™ AD		16																																																																											
<table border="1"> <thead> <tr> <th>Model</th> <th colspan="2">Max Output</th> <th colspan="2">Max Pressure</th> </tr> <tr> <th></th> <th>GPH</th> <th>l/h</th> <th>PSI</th> <th>Bar</th> </tr> </thead> <tbody> <tr> <td colspan="5">EXCEL™ AD with FASTPRIME™</td> </tr> <tr> <td>ADx1</td> <td>0.21</td> <td>0.8</td> <td>250</td> <td>17.2</td> </tr> <tr> <td>ADx4</td> <td>0.5</td> <td>1.9</td> <td>250</td> <td>17.2</td> </tr> <tr> <td>ADx5</td> <td>1.0</td> <td>3.8</td> <td>110</td> <td>7.6</td> </tr> <tr> <td>ADx6</td> <td>2.0</td> <td>7.6</td> <td>50</td> <td>3.4</td> </tr> <tr> <td colspan="5">EXCEL™ AD with AUTOPRIME™</td> </tr> <tr> <td>ADx1</td> <td>0.15</td> <td>0.6</td> <td>250</td> <td>17.2</td> </tr> <tr> <td>ADx4</td> <td>0.33</td> <td>1.2</td> <td>250</td> <td>17.2</td> </tr> <tr> <td>ADx5</td> <td>0.80</td> <td>3.0</td> <td>110</td> <td>7.6</td> </tr> <tr> <td>ADx6</td> <td>1.80</td> <td>6.8</td> <td>50</td> <td>3.4</td> </tr> </tbody> </table>	Model	Max Output		Max Pressure			GPH	l/h	PSI	Bar	EXCEL™ AD with FASTPRIME™					ADx1	0.21	0.8	250	17.2	ADx4	0.5	1.9	250	17.2	ADx5	1.0	3.8	110	7.6	ADx6	2.0	7.6	50	3.4	EXCEL™ AD with AUTOPRIME™					ADx1	0.15	0.6	250	17.2	ADx4	0.33	1.2	250	17.2	ADx5	0.80	3.0	110	7.6	ADx6	1.80	6.8	50	3.4																	
Model	Max Output		Max Pressure																																																																										
	GPH	l/h	PSI	Bar																																																																									
EXCEL™ AD with FASTPRIME™																																																																													
ADx1	0.21	0.8	250	17.2																																																																									
ADx4	0.5	1.9	250	17.2																																																																									
ADx5	1.0	3.8	110	7.6																																																																									
ADx6	2.0	7.6	50	3.4																																																																									
EXCEL™ AD with AUTOPRIME™																																																																													
ADx1	0.15	0.6	250	17.2																																																																									
ADx4	0.33	1.2	250	17.2																																																																									
ADx5	0.80	3.0	110	7.6																																																																									
ADx6	1.80	6.8	50	3.4																																																																									
SERIES B		21																																																																											
<table border="1"> <thead> <tr> <th>Model</th> <th colspan="2">Max Output</th> <th colspan="2">Max Pressure</th> </tr> <tr> <th></th> <th>GPH</th> <th>l/h</th> <th>PSI</th> <th>Bar</th> </tr> </thead> <tbody> <tr> <td colspan="5">Series B with LIQUIPRO™</td> </tr> <tr> <td>Bx1</td> <td>1.6</td> <td>6.1</td> <td>150</td> <td>10.3</td> </tr> <tr> <td>Bx2</td> <td>2.5</td> <td>9.5</td> <td>100</td> <td>6.9</td> </tr> <tr> <td>Bx3</td> <td>4.5</td> <td>17.0</td> <td>50</td> <td>3.4</td> </tr> <tr> <td>Bx4</td> <td>7.0</td> <td>26.5</td> <td>30</td> <td>2.07</td> </tr> <tr> <td colspan="5">Series B with AUTOPRIME™</td> </tr> <tr> <td>Bx1</td> <td>1.4</td> <td>5.3</td> <td>150</td> <td>10.3</td> </tr> <tr> <td>Bx2</td> <td>2.3</td> <td>8.7</td> <td>100</td> <td>6.9</td> </tr> <tr> <td>Bx3</td> <td>4.0</td> <td>15.1</td> <td>50</td> <td>3.4</td> </tr> <tr> <td>Bx4</td> <td>6.8</td> <td>25.7</td> <td>30</td> <td>2.07</td> </tr> </tbody> </table>	Model	Max Output		Max Pressure			GPH	l/h	PSI	Bar	Series B with LIQUIPRO™					Bx1	1.6	6.1	150	10.3	Bx2	2.5	9.5	100	6.9	Bx3	4.5	17.0	50	3.4	Bx4	7.0	26.5	30	2.07	Series B with AUTOPRIME™					Bx1	1.4	5.3	150	10.3	Bx2	2.3	8.7	100	6.9	Bx3	4.0	15.1	50	3.4	Bx4	6.8	25.7	30	2.07																	
Model	Max Output		Max Pressure																																																																										
	GPH	l/h	PSI	Bar																																																																									
Series B with LIQUIPRO™																																																																													
Bx1	1.6	6.1	150	10.3																																																																									
Bx2	2.5	9.5	100	6.9																																																																									
Bx3	4.5	17.0	50	3.4																																																																									
Bx4	7.0	26.5	30	2.07																																																																									
Series B with AUTOPRIME™																																																																													
Bx1	1.4	5.3	150	10.3																																																																									
Bx2	2.3	8.7	100	6.9																																																																									
Bx3	4.0	15.1	50	3.4																																																																									
Bx4	6.8	25.7	30	2.07																																																																									
SERIES C			Page 26																																																																										
<table border="1"> <thead> <tr> <th>Model</th> <th colspan="2">Max Output</th> <th colspan="2">Max Pressure</th> </tr> <tr> <th></th> <th>GPH</th> <th>l/h</th> <th>PSI</th> <th>Bar</th> </tr> </thead> <tbody> <tr> <td colspan="5">Series C with LIQUIPRO™</td> </tr> <tr> <td>Cx0</td> <td>1.3</td> <td>4.9</td> <td>300</td> <td>20.7</td> </tr> <tr> <td>Cx1</td> <td>2.5</td> <td>9.5</td> <td>150</td> <td>10.3</td> </tr> <tr> <td>Cx2</td> <td>4.0</td> <td>15.1</td> <td>100</td> <td>6.9</td> </tr> <tr> <td>Cx3</td> <td>8.0</td> <td>30.3</td> <td>60</td> <td>4.1</td> </tr> <tr> <td>Cx4</td> <td>20.0</td> <td>75.7</td> <td>25</td> <td>1.7</td> </tr> <tr> <td>C76</td> <td>4.0</td> <td>15.1</td> <td>175</td> <td>12.1</td> </tr> <tr> <td>C77</td> <td>10.0</td> <td>38.0</td> <td>80</td> <td>5.5</td> </tr> <tr> <td>C78</td> <td>25.0</td> <td>95.0</td> <td>30</td> <td>2.07</td> </tr> <tr> <td colspan="5">Series C with AUTOPRIME™</td> </tr> <tr> <td>Cx1</td> <td>2.3</td> <td>8.7</td> <td>150</td> <td>10.3</td> </tr> <tr> <td>Cx2</td> <td>3.8</td> <td>14.4</td> <td>100</td> <td>6.9</td> </tr> <tr> <td>Cx3</td> <td>7.8</td> <td>29.5</td> <td>60</td> <td>4.1</td> </tr> </tbody> </table>	Model	Max Output		Max Pressure			GPH	l/h	PSI	Bar	Series C with LIQUIPRO™					Cx0	1.3	4.9	300	20.7	Cx1	2.5	9.5	150	10.3	Cx2	4.0	15.1	100	6.9	Cx3	8.0	30.3	60	4.1	Cx4	20.0	75.7	25	1.7	C76	4.0	15.1	175	12.1	C77	10.0	38.0	80	5.5	C78	25.0	95.0	30	2.07	Series C with AUTOPRIME™					Cx1	2.3	8.7	150	10.3	Cx2	3.8	14.4	100	6.9	Cx3	7.8	29.5	60	4.1		
Model	Max Output		Max Pressure																																																																										
	GPH	l/h	PSI	Bar																																																																									
Series C with LIQUIPRO™																																																																													
Cx0	1.3	4.9	300	20.7																																																																									
Cx1	2.5	9.5	150	10.3																																																																									
Cx2	4.0	15.1	100	6.9																																																																									
Cx3	8.0	30.3	60	4.1																																																																									
Cx4	20.0	75.7	25	1.7																																																																									
C76	4.0	15.1	175	12.1																																																																									
C77	10.0	38.0	80	5.5																																																																									
C78	25.0	95.0	30	2.07																																																																									
Series C with AUTOPRIME™																																																																													
Cx1	2.3	8.7	150	10.3																																																																									
Cx2	3.8	14.4	100	6.9																																																																									
Cx3	7.8	29.5	60	4.1																																																																									
SERIES E - Explosion Proof Pumps			35																																																																										
<table border="1"> <thead> <tr> <th>Model</th> <th colspan="2">Max Output</th> <th colspan="2">Max Pressure</th> </tr> <tr> <th></th> <th>GPH</th> <th>l/h</th> <th>PSI</th> <th>Bar</th> </tr> </thead> <tbody> <tr> <td colspan="5">Series E with LIQUIPRO™</td> </tr> <tr> <td>E70</td> <td>1.3</td> <td>4.9</td> <td>300</td> <td>20.7</td> </tr> <tr> <td>E71</td> <td>2.5</td> <td>9.5</td> <td>150</td> <td>10.3</td> </tr> <tr> <td>E72</td> <td>4.0</td> <td>15.1</td> <td>100</td> <td>6.9</td> </tr> <tr> <td>E73</td> <td>8.0</td> <td>30.3</td> <td>60</td> <td>4.1</td> </tr> <tr> <td>E74</td> <td>20.0</td> <td>76.0</td> <td>25</td> <td>1.7</td> </tr> <tr> <td colspan="5">Series E with AUTOPRIME™</td> </tr> <tr> <td>E71</td> <td>2.3</td> <td>8.7</td> <td>150</td> <td>10.3</td> </tr> <tr> <td>E72</td> <td>3.8</td> <td>14.4</td> <td>100</td> <td>6.9</td> </tr> <tr> <td>E73</td> <td>7.8</td> <td>29.5</td> <td>60</td> <td>4.1</td> </tr> </tbody> </table>	Model	Max Output		Max Pressure			GPH	l/h	PSI	Bar	Series E with LIQUIPRO™					E70	1.3	4.9	300	20.7	E71	2.5	9.5	150	10.3	E72	4.0	15.1	100	6.9	E73	8.0	30.3	60	4.1	E74	20.0	76.0	25	1.7	Series E with AUTOPRIME™					E71	2.3	8.7	150	10.3	E72	3.8	14.4	100	6.9	E73	7.8	29.5	60	4.1																	
Model	Max Output		Max Pressure																																																																										
	GPH	l/h	PSI	Bar																																																																									
Series E with LIQUIPRO™																																																																													
E70	1.3	4.9	300	20.7																																																																									
E71	2.5	9.5	150	10.3																																																																									
E72	4.0	15.1	100	6.9																																																																									
E73	8.0	30.3	60	4.1																																																																									
E74	20.0	76.0	25	1.7																																																																									
Series E with AUTOPRIME™																																																																													
E71	2.3	8.7	150	10.3																																																																									
E72	3.8	14.4	100	6.9																																																																									
E73	7.8	29.5	60	4.1																																																																									
Roytronic A		41																																																																											
Series P		46																																																																											
Series J		52																																																																											
PARTS, ACCESSORIES & INFORMATION																																																																													
Routine Maintenance Kits		57																																																																											
Drive Assemblies		58																																																																											
Liquid End Assemblies		59																																																																											
Accessories		60																																																																											
Electronic Metering Pumps Parts		62																																																																											

SECTION II - MOTOR DRIVEN METERING PUMPS & PARTS		Page																														
EXCEL® XR		79																														
Specifications		80																														
Electronic Control Features		82																														
<table border="1"> <thead> <tr> <th>Model</th> <th colspan="2">Max Output</th> <th colspan="2">Max Pressure</th> </tr> <tr> <th></th> <th>GPH</th> <th>l/h</th> <th>PSI</th> <th>Bar</th> </tr> </thead> <tbody> <tr> <td>XRD2</td> <td>5.6</td> <td>21.2</td> <td>175</td> <td>12.1</td> </tr> <tr> <td>XRD3</td> <td>14</td> <td>53</td> <td>75</td> <td>5.0</td> </tr> <tr> <td>XRD4</td> <td>18</td> <td>68.1</td> <td>50</td> <td>3.5</td> </tr> </tbody> </table>	Model	Max Output		Max Pressure			GPH	l/h	PSI	Bar	XRD2	5.6	21.2	175	12.1	XRD3	14	53	75	5.0	XRD4	18	68.1	50	3.5							
Model	Max Output		Max Pressure																													
	GPH	l/h	PSI	Bar																												
XRD2	5.6	21.2	175	12.1																												
XRD3	14	53	75	5.0																												
XRD4	18	68.1	50	3.5																												
EXCEL™ XR Accessories		87																														
EXCEL™ XR Pump Parts		89																														
SERIES G		90																														
<table border="1"> <thead> <tr> <th>Model</th> <th colspan="2">Max Output</th> <th colspan="2">Max Pressure</th> </tr> <tr> <th>SD</th> <th>GPH</th> <th>l/h</th> <th>PSI</th> <th>Bar</th> </tr> </thead> <tbody> <tr> <td>SD2</td> <td>0.7</td> <td>2.6</td> <td>175</td> <td>12.1</td> </tr> <tr> <td>SD4</td> <td>12</td> <td>45</td> <td>150</td> <td>10.3</td> </tr> <tr> <td>SD7</td> <td>50</td> <td>189</td> <td>100</td> <td>6.9</td> </tr> <tr> <td>SD8</td> <td>115</td> <td>435</td> <td>75</td> <td>5.2</td> </tr> </tbody> </table>	Model	Max Output		Max Pressure		SD	GPH	l/h	PSI	Bar	SD2	0.7	2.6	175	12.1	SD4	12	45	150	10.3	SD7	50	189	100	6.9	SD8	115	435	75	5.2		
Model	Max Output		Max Pressure																													
SD	GPH	l/h	PSI	Bar																												
SD2	0.7	2.6	175	12.1																												
SD4	12	45	150	10.3																												
SD7	50	189	100	6.9																												
SD8	115	435	75	5.2																												
<table border="1"> <thead> <tr> <th>Model</th> <th colspan="2">Max Output</th> <th colspan="2">Max Pressure</th> </tr> <tr> <th>SG</th> <th>GPH</th> <th>l/h</th> <th>PSI</th> <th>Bar</th> </tr> </thead> <tbody> <tr> <td>SG5</td> <td>106</td> <td>400</td> <td>150</td> <td>10.3</td> </tr> <tr> <td>SG6</td> <td>147</td> <td>556</td> <td>100</td> <td>6.9</td> </tr> <tr> <td>SG7</td> <td>300</td> <td>1136</td> <td>50</td> <td>3.4</td> </tr> </tbody> </table>	Model	Max Output		Max Pressure		SG	GPH	l/h	PSI	Bar	SG5	106	400	150	10.3	SG6	147	556	100	6.9	SG7	300	1136	50	3.4							
Model	Max Output		Max Pressure																													
SG	GPH	l/h	PSI	Bar																												
SG5	106	400	150	10.3																												
SG6	147	556	100	6.9																												
SG7	300	1136	50	3.4																												
Series G Pump Parts		103																														
SECTION III - CONTROLLERS & ACCESSORIES																																
LIQUITRON™ Conductivity Controllers																																
DC4000 Boiler Controller		107																														
DC4500 Cooling Tower Controller		108																														
Accessories		109																														
Spare Parts		110																														
LIQUITRON™ pH/ORP Controllers																																
DP5000 pH Controller		111																														
DR5000 ORP (Redox) Controller		111																														
pH/ORP Controllers - Accessories		112																														
pH/ORP Controllers - Spare Parts		113																														
FS5000 Flow Switch Controller		114																														
TS5000 Time Switch (#33424)		114																														

Minimum Advertised Price Policy

Revision effective April 1, 2018

As one of the world's leading producers and suppliers of pumps, water treatment controllers, and metering pumps, Milton Roy is focused on ensuring that customers receive the high quality products and support that Milton Roy seeks to have associated with the company's trademarks, including the LMI brand. That requires ensuring that every tier of the distribution chain—including Master Distributors and the Sub-distributors/Resellers—has the economic incentive to make the investment necessary to provide the quality of product sales and support that a premium brand like LMI needs and deserves. Consistent with our brand strategy and marketing, we have developed the following Minimum Advertised Price ("MAP") policy for LMI products. We have adopted this MAP Policy to prevent advertising that tends to depreciate or degrade the image and positioning of Milton Roy's LMI brand, products, and trademarks in the marketplace, thereby eroding goodwill and brand reputation. We also want to ensure that Master Distributors of LMI products and support services are not undermined by the advertising of "free riding" distributors that do not offer such services. By adhering to this MAP Policy, Master Distributors are likely to benefit from enhanced profitability, customer loyalty, and product image. All Master Distributors are prohibited from directly or indirectly violating this MAP policy.

Milton Roy MAP Policy Guidelines

MAP pricing for all products can be found on your current price list and is equal to the current LIST PRICE. All advertised prices must be at or above MAP for all products if a MAP price has been established by Milton Roy. Master Distributors are not required to list prices in advertising. If a price is listed in an advertisement, however, it must be at or above MAP. Other statements such as "call for price" or "call for quote" are acceptable and permitted. Master Distributors are also responsible for ensuring that their product pricing is at or above MAP on Internet search engines. Master Distributors are free to set the actual resale price of any product but are encouraged to maintain resale prices at or above the MAP price as published in the most recent price list.

This policy applies to advertising placements, including print ads (inserts, magazines, newspapers, catalogs, mail order catalogs, etc.), broadcast (radio and TV), direct mail, faxes, Internet placement with third parties (banner ads, broadcast emails, destination pages, third-party sites), Internet placements on a Master Distributor's own website, and any flyers, posters, or coupons.

Master Distributors of LMI products are encouraged to supply a copy of this policy to any new or existing Sub-distributors/Resellers.

Pricing Statements

This MAP Policy does allow Master Distributors to omit pricing entirely from advertisements and/or advertisement statements such as "Call for Price" or "Call for Quote."

Free Offers

Free shipping and/or handling, 0% sales tax, or free financing promotions do not violate the MAP Policy.

Products Price Matching Policies

Price matching policies are acceptable. Price matching cannot be used as a valid reason for violations of this MAP Policy, and violations by other distributors or resellers does not grant a Master Distributor or anyone else a right to violate the MAP policy. The Master Distributor's advertised price must always be at MAP or higher.

Practices Inconsistent with the Minimum Advertised Price Policy

Advertising practices that are inconsistent with and a violation of the MAP Policy are not permitted. While it is not possible to list all such inconsistent practices, some of them are listed below:

- Advertising LMI products below the MAP, in any medium (including in-store, print, audio, video, Internet communications or online).
- In eCommerce transactions, "see cart for pricing" are inconsistent with LMI brand guidelines if the consumer is not required to enter a specific log in (i.e. account number) or password to see this pricing.
- Website features such as "click for price", automated "bounce-back" pricing e-mails, preformatted e-mail responses, forms, and automatic price display for any items prior to being placed in a customer's shopping cart, and other similar features are considered to be communications initiated by the distributor (rather than by the customer) and thereby constitute "advertising" under this MAP Policy. Thus, these actions will be non-compliant with this policy
- Advertising volume discounts that are less than MAP price at the individual SKU level will be considered a violation of this policy.
- Unapproved coupons specifically for LMI products.
- Use of generic coupons for any merchandise in the store or online, when the use of that coupon is "netted out" or shown in an advertisement for LMI products. *(With respect to coupons that cover any and all of the merchandise in a retailer's store, while it is our strong preference that LMI products be excluded from such coupons, we will not consider such all merchandise coupons to be an inconsistent practice).*
- If a distributor or wholesaler with multiple store locations violates the MAP Policy at any one store location, or on any associated website, then LMI will consider this to be a violation by the distributor or wholesaler.

Enforcement of the Minimum Advertised Price Policy

LMI and the Master Distributor channel will monitor the practices of distributors and resellers either directly or via 3rd party agencies and/or analytical tools in all markets. Distributors and Wholesalers are expected to provide reasonable cooperation in any LMI investigations regarding possible MAP Policy violations. Hindering or otherwise failing to cooperate with an LMI MAP Policy investigation will be considered a violation of the MAP Policy. Upon discovering that a Master Distributor, distributor or reseller is engaging in any inconsistent practice as described above, LMI will take the actions outlined below, unilaterally and without consultation or agreement with either the non-compliant Master Distributors, distributors or reseller or others. LMI will hold authorized Master Distributors responsible for actions by their resellers or sub-distributors that violate the MAP policy.

- *If an initial violation occurs, the Master Distributor Channel will be expected make all attempts to work through the violation without involvement from LMI. If or when a resolution cannot be reached, LMI may be contacted for an interpretation of the expected guidelines and to give LMI notice of the violation.*
- *If a second violation occurs, LMI will issue an official warning to the Master Distributor responsible for the offending conduct or the offending distributor or reseller. Upon receipt of such letter, the responsible Master Distributor will have 10 working days to respond with an explanation and/or steps to resolve the matter. This response will be sent to LMI for records keeping.*
- *Further violations can result in any or all of the following actions:*
 - *Restrict future orders to the offending distributor and/or reseller to be enforced by the Master Distributor. Proof must be provided to LMI of enforcement.*
 - *Place Regional Responsibility under review for a period of 60 days*
 - *Terminate our business relationship with non-compliant Master Distributors. Such a decision will be made by the LMI management team.*

Failure to Comply with the MAP Policy

At the sole discretion of Milton Roy, failure to comply with this policy may result in a decision by Milton Roy not to sell products to a Master Distributor in the future and to terminate any agreement(s) in place with a Master Distributor.

CHEMICAL RESISTANCE GUIDE

This guide is offered as a general aid in selecting the appropriate materials used for a broad spectrum of aggressive chemicals routinely handled by the products we manufacture. Because chemicals and their properties can vary greatly, this chart is to be used at your discretion. The accuracy of these ratings cannot be guaranteed. Your chemical supplier is the best source for definitive material compatibility. Careful consideration must be given to all characteristics of the chemical and process system including chemical concentration, installation conditions, pressure, and temperature before a final material is selected.

Although the information set forth herein is presented in good faith and believed to be correct at date of issuance, LMI makes no guarantee or representation as to the completeness or accuracy thereof, and disclaims all liability for any loss or damage resulting from use or reliance upon any information, recommendations or suggestions contained herein. LMI MAKES NO EXPRESS OR IMPLIED REPRESENTATIONS OF WARRANTIES AS TO THE FITNESS, MERCHANTABILITY, OR ANY OTHER MATTER WITH RESPECT TO THE INFORMATION CONTAINED HEREIN OR ANY PRODUCT OR SUBSTANCE REFERRED TO HEREIN, whether used alone or in combination with any other material. Nothing contained herein is to be construed as a recommendation to use any product in conflict with any patent. The information is subject to change without notice.

These materials represent the majority of standard liquid end materials used with products we manufacture.

As always, you can rely on your LMI distributor to help with standard and unique applications. Refer to the most current chemical resistance guide by scanning the QR Code or searching for “chemical resistance guide” on support.lmipumps.com.



MATERIAL DESCRIPTIONS

METAL WETTED COMPONENTS

316 Stainless Steel – alloy of iron, carbon, nickel and chromium. A nonmagnetic stainless steel with more ductility than 400SS. Austenitic in structure, 316 stainless steel has excellent corrosion resistance to a wide range of chemicals. It is not susceptible to stress corrosion cracking or affected by heat treatment. 316 stainless steel is the most widely used material for pump heads, check valves, balls and other wetted components.

Alloy 20 – contains more nickel and chromium than 300 series stainless steel and with the addition of columbium that retards stress corrosion cracking and has improved resistance to sulfuric acid.

Alloy C – a high nickel-chromium molybdenum alloy that has outstanding resistance to a wide variety of chemical process environments, including strong oxidizers such as sodium hypochlorite, and ferric chloride. Alloy C is also resistant to nitric, hydrochloric, and sulfuric acids at moderate temperatures. It's often used as spring material in check valves of non-metallic pumps. Two grades of Alloy C are used in pump components, C276® and C22®. The two grades differ slightly in chemical compatibility, so care should be taken in the selection process.

NON-METAL WETTED COMPONENTS

Acrylic – resistant to many chemicals. Acrylic is often favored over other plastics for use as pump head material because it is clear and enables the user to observe pump performance.

Ceramic – Is used for seats, weights and ball checks in a number of pump products. Ceramic has the advantages of having a high level of hardness while being very corrosion resistant to a wide range of chemicals even at elevated temperatures. Alumina is not compatible with some chemicals such as hydrofluoric, hydrofluorosilicic, and hydrochloric acids.

Polyethylene – has excellent chemical resistance to strong acids and bases. It is also resistant to gentle oxidants and reducing agents. Its primary use in pumps is as a seat material in pump heads made primarily of other plastic materials.

Polypropylene – is generally high in chemical resistance but slightly lower in physical properties compared to PVC. It is chemically resistant to organic solvents, acids, and alkalines. It is typically not effective when in contact with strong oxidizing acids, chlorinated hydrocarbons, and aromatics.

PVC – PVC is the most frequently specified of all thermoplastic materials. It is characterized by high physical properties and resistance to corrosion and chemical attack by acids, alkalines, salt solutions, and many other chemicals. It is not successful handling ketones, some chlorinated hydrocarbons, and aromatics. The maximum service temperature of PVC is 140°F. PVC pipe connections can be solvent cemented (recommended for many chemicals) threaded, or flanged.

PVDF – a strong and abrasion-resistant fluorocarbon material. It resists distortion and retains most of its strength to 280°F. PVDF is excellent with most acids, bases, and organic solvents. It also applies well to chlorine, bromine and other halogens. No other plastic material approaches the combination of strength, chemical resistance and working temperatures of PVDF. PVDF is joined by a fusion process, threading or flanging.

NOTE: For applications where Alloy C springs are not compatible, PVDF coated springs are available.

NOTE: For unlisted chemicals, consult your LMI distributor or chemical manufacturer.

NOTE REFERENCES

1. Consult LMI distributor
2. Absorption of moisture from the air dilutes chemical and increases corrosion.
3. Consult LMI distributor for assistance
4. Consult LMI distributor - Slurry - use HV liquid ends
5. Liquefied gas - consult LMI distributor
6. Polypropylene only good to 38% concentration.
7. Polypropylene, PEEK, and FKM up to 80 % concentration.
8. Recommend liquid end flush
9. Recommend liquid end flushing
10. Subject to gas binding - use degassing head.
11. Use 316 ss if Titanium Dioxide must remain white
12. Use degassing head, double ball checks, Polyethylene must be HDPE
13. Use liquid ends with HV options
14. Use high alumina ceramic ball checks
15. Use HV liquid ends
16. Use PTFE ball checks
17. Use slurry checks
18. Usually requires high temp options - Consult LMI distributor
19. Volatile with hydrocarbons - Subject to gas binding - use degassing head.
20. Can be very corrosive - recommend plastics
21. High specific gravity - use spring loaded checks

Literature #: 53953.B

Rev Date: 12/2017

ELASTOMERS AND SEALS

POLYPREL® (TFE/P) – is a copolymer of tetrafluoroethylene and propylene with a fluorine content of about 54%. This material is resistant to petroleum products and phosphate-esters. Service temperatures are -25°F to 400°F. Polyprel® provides improved chemical resistance to a wide spectrum of oils, rust inhibitors, amines, acids and bases. Polyprel® is typically used for o-rings in various pump models.

Nitrile (Buna-N) – a general purpose oil-resistant polymer known as nitrile rubber. Nitrile is a copolymer of butadiene and acrylonitrile with a moderate temperature range of -20°F to 180°F. Nitrile is resistant with solvents, oils, water, and hydraulic fluid. Nitrile should not be used with highly polar solvents such as acetone and methyl ethyl ketone, or in applications with chlorinated hydrocarbons, ozone or nitro hydrocarbons. In metering pumps Nitrile is primarily used for o-ring seals.

EPDM – EPDM has good abrasion and tear resistance and offers excellent chemical resistance to a variety of acids and alkalines. It is susceptible to attack by oils and is not recommended for applications involving petroleum oils, strong acids, or strong alkalines. It is fairly good with ketones and alcohols and has a temperature range from -20°F to 250°F.

PEEK – Polyetheretherketone is a high-performance engineered thermoplastic that can be used as diaphragm material when an application exceeds PTFE temperature or tensile strength limits. PEEK can be used up to 550°F.

PTFE/FLUOROFILM™ – has outstanding resistance to chemical attack by most chemicals and solvents. PTFE has a wide temperature rating of -20°F to 400°F as a seal. It is also used as the primary material in diaphragms where temperature limits vary based on backing material. FluoroFilm™ is a copolymer of PTFE and PFA.

FKM – compatible with a broad range of chemicals. FKM is usually used for o-rings, and as a backing material for PTFE diaphragms. It can also be used for ball checks. FKM can be used in most applications involving mineral acids, salt solutions, chlorinated hydrocarbons, and petroleum oils. It is also good in hydrocarbon service. FKM has a temperature range of -20°F to 300°F.

Solution Temperature Maximum

For liquid handling components of LMI metering pumps operation at 100 psi (6.9 Bar)

Material	Example Of Use	Temperature	
		°F	°C
PVDF (Carbon Fiber Reinforced)	Fittings and Pump Head	250*	121*
Polyprel® (TFE/P)	Seal Rings	250*	121*
Polypropylene	Fittings and Pump Head	170	77
Polyvinyl Chloride Rigid (PVC)	Fittings and Pump Head	140	60
Polyvinyl Chloride (Flexible Vinyl)	Suction Tubing	140	60
Polyethylene	Discharge Tubing	110	43
Acrylic	Pump Head	140	60
PTFE	Liquifram™ and Seal Rings	250*	121*
FKM	Diaphragm and Seal Rings	225	107
Stainless Steel (316)	Fittings and Pump Head	250*	121*
Copolymer PTFE	Liquifram™	250*	121*
Alloy C	Spring	250*	121*
EPDM	Seal Rings	225	107
CPVC	Pipe and Corp Stop	180	82
Nitrile (Buna-N)	Gasket and Corp Stop	220	104
PEEK	Diaphragm	550	288
Alloy 20	Balls and Seats	250*	121*
Ceramic	Balls	250*	121*

* Limited by other pump components

RATINGS:

A - Excellent

B - Use with caution

C - Do not use

_ (Underscore) - Insufficient Data

Temperature - Good up to listed temperature

Material Code	2	3	5	7	8	9	0	Note Reference #
Head	PVDF	PVDF	PP	316ss	PVC	Acrylic	Acrylic	
Fittings	PVDF	PVDF	PP	316ss	PVC	PVDF	PVC	
Balls	Ceramic	Ceramic	Ceramic	316ss	Ceramic	PTFE	Ceramic	
Seats	Polyprel®	PTFE	PTFE	316ss	Polyprel®	Polyprel®	PTFE	
O-Rings	Polyprel®	PTFE	PTFE	PTFE	Polyprel®	Polyprel®	Polyprel®	
Chemical	Liquid End Chemical Resistance Rating							#
Acetic Acid 10%	C	A 220°F	A 250°F	A 250°F	C	C	C	
Acetic Acid 80%	C	A 150°F	C	C	C	C	C	
Acetic Acid Glacial	C	A 125°F	A 68°F	A 250°F	C	C	C	
Acetic Anhydride	C	C	C	A 250°F	C	C	C	
Alum (general - see specific chemical)				C		A		
Aluminum Chloride	A 230°F	A 212°F	A 212°F	A 212°F	A	A 212°F	A 212°F	
Aluminum Hydroxide				A 212°F		A 212°F		
Aluminum Sulfate		A 212°F	A 212°F	A 212°F				
Amines				A				
Amines (filming)			C	A				
Ammonia Solutions	C	C	A 250°F	A 250°F				
Ammonia, Anhydrous	C	C		A 250°F		C	C	
Ammonium Sulfate	C	A 230°F	A 250°F	A 250°F	C	C	C	
Bromine	B 125°F	A 125°F	C	C	C	C	C	
Calcium Carbonate	A 230°F	A 230°F	A 250°F	A 250°F	A	A 230°F	A 250°F	
Calcium Chloride	A 230°F	A 230°F	A 250°F	A 250°F	C	A	A 230°F	A 250°F
Calcium Hydroxide	A 230°F	A 212°F	A 212°F	A 212°F	A	A 212°F	A 212°F	
Calcium Hypochlorite	A 200°F	A 200°F	A 212°F	C	A	A 200°F	A 212°F	
Carbolic Acid (See Phenol)			A 250°F	A 250°F				
Carbonic Acid	A 230°F	A 230°F	A 250°F	A 250°F	A	A 230°F	A 250°F	
Chlorine Dioxide		B						
Chromic Acid 10%	A 175°F	A 175°F	A 250°F		A	C	C	
Chromic Acid 50% below 60°F	A 125°F	A 125°F	C	A 250°F	A	C	C	
Chromic Acid 50% to 140°F	A 125°F	A 125°F	C	C	A	C	C	
Citric Acid	A 230°F	A 212°F	A 212°F	A 212°F	A	A 212°F	A 212°F	
Copper Sulfate				A 212°F		A 212°F		
Copper Sulfate (5% Solution)	A 230°F	A 212°F		A 212°F		A 212°F		
Detergents			A 250°F		B		B 250°F	
Ethyl Acetate	C	C	C	A 250°F	C	C	C	
Ethyl Chloride	A 230°F	A 230°F	C	A 250°F	C	C	C	
Ethylene Glycol	A 230°F	A 230°F	A 250°F	A 250°F	A	A 230°F	A 250°F	
Ferric Chloride				C		A 230°F		8
Ferric Nitrate				A 250°F		A 230°F		
Ferric Sulfate	A 230°F	A 230°F	A 250°F	A 250°F	A	A 230°F	A 250°F	1
Ferrous Chloride				C		A 230°F		
Ferrous Sulfate	A 230°F	A 230°F	A 250°F	C	A	A 230°F	A 250°F	
Fluosilicic Acid	C	C	C	C	C	A 230°F	C	16
Glycerine	A 230°F	A 230°F	A 250°F	A 250°F	A	A 230°F	A 250°F	
Hydrobromic Acid 50%				C		A 230°F		3
Hydrochloric Acid	B 230°F	B 230°F	B 250°F	C	B	A 230°F	B 250°F	6
Hydrochloric Acid- Anhydrous		B 230°F	C	C				3
Hydrofluoric Acid 30%	C	C	C	C	C	C	C	16
Hydrofluoric Acid 75%	C	C	C	C	C	C	C	16
Hydrofluoric Acid 100%	C	C	C	C	C	C	C	16
Hydrofluosilicic Acid	C	C	C	C	C	A 212°F	C	16
Hydrogen Peroxide - Consult LMI Distributor	C	A 250°F	A 250°F	C		C		19
Hydrogen Sulfide, Aqueous	A 230°F	A 230°F	A 250°F	A 250°F	A	A 230°F	A 250°F	
Iodine Solutions			C	C	C	A 150°F	C	
Isopropyl Alcohol	A 140°F	A 140°F	A 250°F	C	A	C	C	
Lactic Acid (over 60% to 100°F)	A 125°F	A 125°F	C	C	C	A 125°F	C	
Lactic Acid (to 60% to 100°F)	A 125°F	A 125°F	C	C	C	A 125°F	C	
Lime Slurries				A 212°F	C			13
Magnesium Chloride	A 230°F	A 230°F	A 250°F	C	A	A 230°F	A 250°F	
Magnesium Hydroxide	A 230°F	A 230°F	A 250°F	A 250°F	A	A 230°F	A 250°F	17
Magnesium Nitrate	A 230°F	A 230°F	A 250°F	A 250°F	A	A 230°F	A 250°F	
Magnesium Sulfate				A 250°F				
Maleic Acid				A 250°F				
Malic Acid			C	A 250°F				
Methanol (Methyl Alcohol 100%)	A 230°F	A 230°F	A 250°F	A 250°F	A	C	C	
Mineral Oil	A 230°F	A 230°F	A 250°F	A 250°F	C	A 230°F	C	
Nitric Acid 10%	A 175°F	A 175°F	C	A 250°F	A	C	C	
Nitric Acid 70% to 100°F	B 125°F	A 125°F	C	C	B	C	C	
Nitric Acid Concentrated	B	A 70°F	C	A 70°F	C	C	C	
Peracetic Acid (PAA)		A	A					12
Phosphoric Acid	A 220°F	A 220°F	A 250°F	A 250°F	A	A 220°F	A 250°F	7

RATINGS:**A** - Excellent**B** - Use with caution**C** - Do not use**_** (Underscore) - Insufficient Data**Temperature** - Good up to listed temperature

Material Code	2	3	5	7	8	9	0	Note Reference
Head	PVDF	PVDF	PP	316ss	PVC	Acrylic	Acrylic	
Fittings	PVDF	PVDF	PP	316ss	PVC	PVDF	PVC	
Balls	Ceramic	Ceramic	Ceramic	316ss	Ceramic	PTFE	Ceramic	
Seats	Polyprel®	PTFE	PTFE	316ss	Polyprel®	Polyprel®	PTFE	
O-Rings	Polyprel®	PTFE	PTFE	PTFE	Polyprel®	Polyprel®	Polyprel®	
Chemical	Liquid End Chemical Resistance Rating							#
Phthalic Acid	-	-	-	A 250°F	C	B 200°F	C	
Potassium Bicarbonate	-	A 200°F	A 250°F	A 250°F	-	-	-	
Potassium Bromide	C	C	C	A 250°F	C	A 230°F	C	
Potassium Carbonate	-	C	C	A 250°F	-	-	-	
Potassium Chlorate	B 200°F	B 200°F	B 250°F	A 250°F	B	A 200°F	B 250°F	
Potassium Chloride	-	-	-	A 250°F	-	A 230°F	-	
Potassium Fluoride	-	-	-	A 250°F	C	-	-	
Potassium Hydroxide	A	A 250°F	A 250°F	A 250°F	A	A 250°F	A 250°F	
Potassium Nitrate	B 230°F	B 230°F	B 250°F	A 250°F	B	A 230°F	B 250°F	
Potassium Permanganate	A 230°F	A 230°F	C	A 250°F	A	A 230°F	A 250°F	1
Potassium Sulfate	A 230°F	A 230°F	A 250°F	A 250°F	A	A 230°F	A 250°F	
Potassium Sulfide	-	A 230°F	A 250°F	A 250°F	-	-	-	
Soda Ash (See Sodium Carbonate)	-	-	-	-	-	A 230°F	-	8
Sodium Acetate	C	A 230°F	A 250°F	A 250°F	C	C	C	
Sodium Aluminate	-	-	-	A 212°F	C	-	-	1
Sodium Aluminum Sulfate (Soda Alum)	-	-	-	A	C	-	-	
Sodium Bicarbonate	A 230°F	A 230°F	A 250°F	A 250°F	A	A 230°F	A 250°F	
Sodium Bisulfate (to 100°F)	A 230°F	A 230°F	A 250°F	C	A	A 230°F	A 250°F	
Sodium Bisulfite (to 100°F)	A 230°F	A 230°F	A 250°F	A 250°F	A	A 230°F	A 250°F	
Sodium Borate (Borax)	A 230°F	A 230°F	A 250°F	A 250°F	A	A 230°F	A 250°F	
Sodium Carbonate (Soda Ash)	A 230°F	A 230°F	A 250°F	A 250°F	A	A 230°F	A 250°F	
Sodium Chlorate	-	A 230°F	A 250°F	A 250°F	-	-	-	
Sodium Chloride	-	-	A 250°F	C	A	-	A 250°F	
Sodium Cyanide	A 230°F	A 230°F	A 250°F	A 250°F	A	A 230°F	A 250°F	
Sodium Fluoride	C	C	C	C	C	A 230°F	C	16
Sodium Hydroxide 20% (75° to 210°F)	A	A 250°F	-	A 250°F	A	A 250°F	A 250°F	
Sodium Hydroxide 20% (to 75°F)	A	A 250°F	A 250°F	A 250°F	A	A 250°F	A 250°F	
Sodium Hydroxide 50% (75°F)	A	A 250°F	C	A 250°F	A	A 250°F	A 250°F	1
Sodium Hydroxide 50% (75° to 175°F)	A	A 250°F	-	A 250°F	A	A 250°F	A 250°F	1
Sodium Hypochlorite	A 200°F	A 200°F	C	C	A	A 200°F	A 250°F	10
Sodium Nitrate	C	A 230°F	A 250°F	A 250°F	C	C	C	
Sodium Permanganate	-	-	C	A	-	-	-	
Sodium Peroxide	-	-	-	A 250°F	C	-	-	
Sodium Polyphosphate	-	-	-	A 212°F	-	-	-	
Sodium Silicate	A	A 250°F	A 250°F	A 250°F	C	A 250°F	C	9
Sodium Sulfate	A	A 250°F	A 250°F	A 250°F	A	A 250°F	A 250°F	
Sodium Sulfide	A	A 250°F	A 250°F	A 250°F	C	-	-	
Sodium Sulfite	-	-	-	A 250°F	-	-	-	
Sulfuric Acid (40% to 95%)	A 200°F	A 200°F	C	C	A	C	C	2
Sulfuric Acid (95% to 100%)	A 125°F	A 125°F	C	C	A	C	C	2
Sulfuric Acid (up to 40%)	A 230°F	A 230°F	A 250°F	C	A	C	C	2
Tannic Acid	B 230°F	A 230°F	A 250°F	A 250°F	B	-	-	
Vinegar	A 230°F	A 230°F	A 250°F	A 250°F	A	A 230°F	A 250°F	
Water, Deionized	-	B 230°F	B 250°F	A 250°F	-	-	-	20
Water, Distilled	-	-	-	A	-	-	-	
Water, Fresh	A 230°F	A 230°F	-	-	-	A 230°F	-	
Water, Salt	B 230°F	B 230°F	B 250°F	A 250°F	B	A 230°F	B 250°F	
Xylene	C	A 200°F	C	A 250°F	C	C	C	
Zinc Chloride	C	C	C	C	C	A 230°F	C	
Zinc Sulfate	C	C	C	A 250°F	C	A 230°F	C	

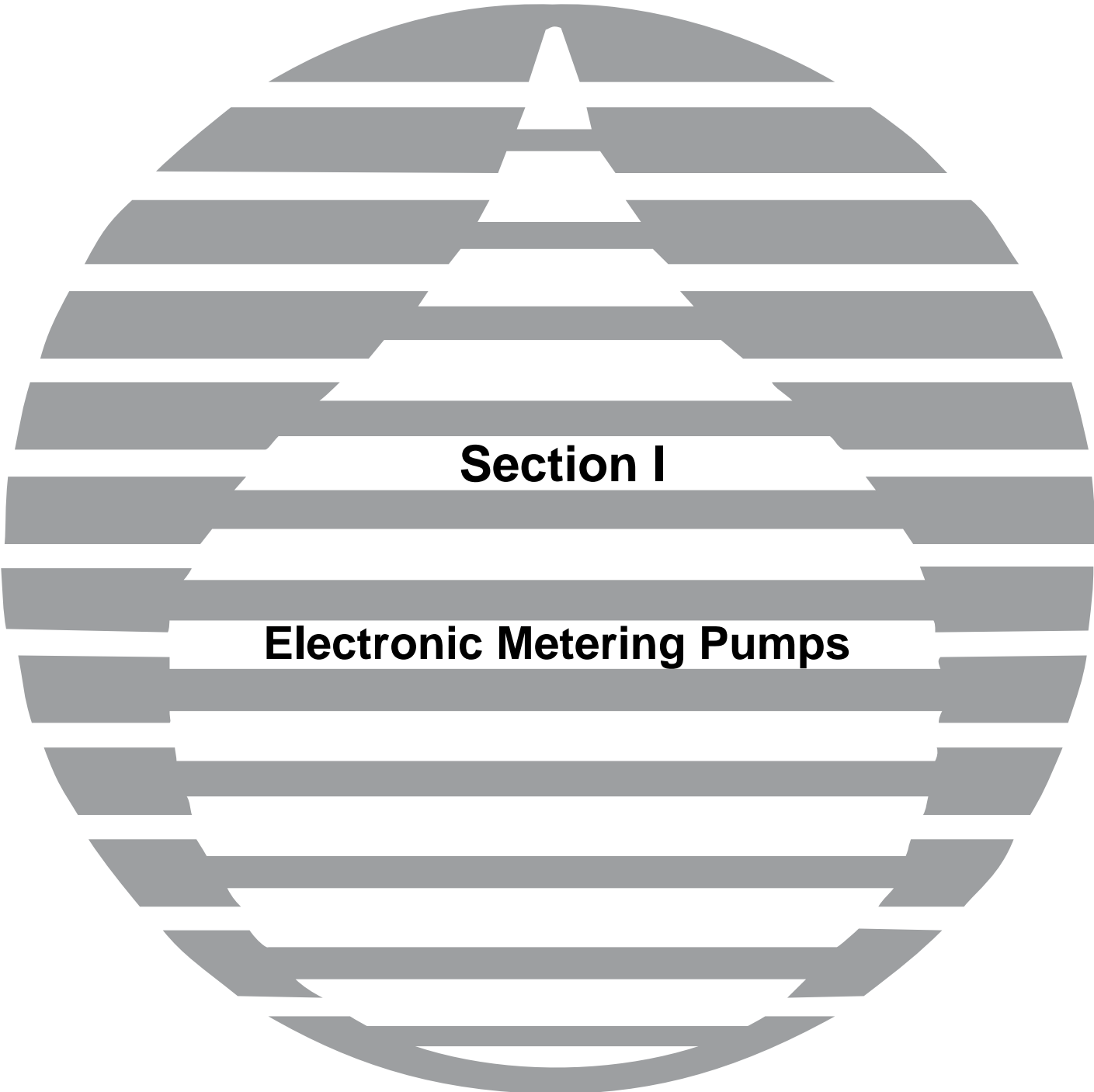

Section I

Electronic Metering Pumps

LMI METERING PUMPS

Each LMI Metering Pump series is designed to meet user needs for specific application and installation requirements. Within each series there are a number of options for controls, liquid end designs and materials, power, and various other accessories and features.

The following price pages are presented in four groups so each can be described by the features offered:

- Series PD** - LMI P series with liquid end features applied to a familiar pump series.
- EXCEL™ AD** - LMI's digital pump line with the latest control and liquid end features.
- Series B, C, E, P, and J** - All share common drives, control, or liquid end features.

Each section has a page in the beginning that describes the features and options available.

Note: All standard plastic liquid ends are shipped with PE tubing. PE tubing is not recommended for all applications, therefore, please refer to the LMI Chemical Resistance chart for material compatibility. When PE tubing is not suitable for the application, please contact your local master distributor for alternative tubing materials.

Application Notes

- **Off-gassing Fluids (such as Sodium Hypochlorite)** - Each pump series that offers special designs for these fluids has a separate selection table at the end of the pricing section (reference AUTOPRIME™ Liquid Ends). Pumps designed to handle these fluids are specially designed to automatically bleed a portion of the process chemical in order to eliminate gas binding of the liquid end. The pump capacity ratings take into account the continuous bleed. For applications of off-gassing liquids such as sodium hypochlorite or hydrogen peroxide, "AI" or "HI" liquid ends with AUTOPRIME™ heads or valves are recommended. An "HI" liquid end adds a 4FV to the "AI" liquid end. AUTOPRIME™ is available on PVC and Acrylic heads. A 4FV on the "HI" head enables safe pressure release of process fluid.
- **Explosion-Proof Applications** - LMI's Series E pumps are designed to operate in hazardous areas requiring explosion proof equipment.
- **High Viscosity Fluids, Polymers** - Use EXCEL™ AD Series High Viscosity Liquid End Assemblies 624xx, 626xx, 634xx, 636xx, 644xx or 646xx with corresponding size drive assembly. For B, C, E, and J pump series, use Liquid End Assemblies 20HV, 25HV, 75HV, 76HV, 85HV, or 86HV with corresponding size drive assembly. Pump output may be reduced in some applications. Also, please note that no foot valve is included with HV liquid ends.
- **Stainless Steel Liquid Ends** - Liquid End Assemblies with a "7" in the second or third position. Please note no foot valve or injection valves are included with these Stainless Steel liquid ends. 316ss liquid ends are only available in NPT connections and without 4 function valves. Separate back pressure and safety valves are available in the accessory section.
- **Accessories** - Contact your LMI distributor to discuss the variety of LMI accessories designed to make the installation and operation of your LMI pump easier and more efficient.
- **Hastelloy® C Head Screws** - are available for pumps that will be used with strong acids or other applications where Hastelloy® C will provide better results than the standard 316 S.S. head screws. Please refer to the LMI Chemical Resistance chart and to your chemical supplier for suggested materials. See head screw kits: #37144 and #38735.
- **UV Resistant Tubing** - Black UV resistant tubing kits are available as item numbers #54783, #54784, and #54793. Each UV Tubing Kit will contain (1) six foot 1/4 inch diameter bleed line and (1) sixteen foot suction/discharge line in either a 1/4 inch, 3/8 inch or 1/2 inch diameter (respectively)

SERIES PD METERING PUMPS



FastPrime™ Liquid Ends

Output	PSI	GPH	BAR	LPH
PDx1	450	0.10	30.6	0.38
	300	0.20	20.4	0.76
	150	0.25	10.3	0.95
PDx4	250	0.35	17.3	1.32
	150	0.52	10.3	1.97
	50	0.68	3.4	2.6
PDx5	150	0.80	10.3	3.0
	110	1.00	7.6	3.8
	30	1.10	2.0	4.2
PDx6	70	1.70	4.8	6.4
	60	1.85	4.1	7.0
	50	2.00	3.4	7.6

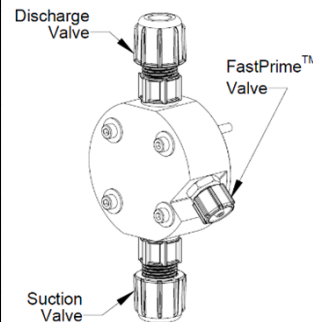

For support:



FastPrime™ Has an integral manual priming valve to facilitate quick pump start-up.

Control Codes

Key Features	PD0	PD7
Stroke frequency manually adjustable	✓	✓
Pulse signal input controls frequency		✓
Remote Start/Stop		✓
Low level float switch input		✓
Enhanced functionality		
• Calibration assist		✓
• System & user totalizer		
• StayPrime™ Degassing Technology		

AutoPrime™ Liquid Ends

Output	PSI	GPH	BAR	LPH
PDx4	250	0.20	17.3	0.76
	150	0.30	10.3	1.14
PDx5	110	0.75	7.6	2.8
	50	0.85	3.4	3.22
PDx6	50	1.75	3.4	6.6
	30	1.85	2.0	7.0

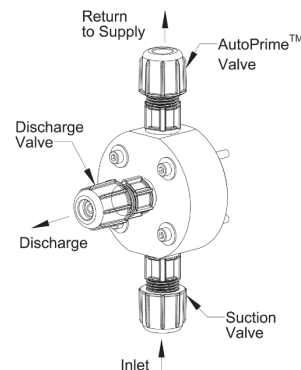

AutoPrime™ Allows for the constant removal of vapors and gases present in applications like sodium hypochlorite and hydrogen peroxide.



4 Function Valve

- This diaphragm type, anti-syphon/pressure relief valve is installed on the pump head.
- Can be oriented as required (360°) at precisely the desired position.
- Easier to use thanks to the more user-friendly design of the priming knobs and back pressure valve

What's in the Box

PD Series units include:					PD7 units include:
Stainless Steel LE units					

SERIES PD METERING PUMP SELECTION AND PRICING

OUTPUT CODE 1

160 SPM Max.

Size Code 0

0.25 GPH (0.95 LPH); 450 psi (30.6 bar) **AutoPrime™** 0.001 to 0.13 GPH (0.005 to 0.5 LPH); 150 psi (10.3 bar)

PDx1								Price	
Drive End									
Control									
PD01 Manual Control								\$ 315	
PD71 Enhanced control with Pulse Input, Remote Stop/Start, and Tank Level Input								\$ 540	
Power Code	Voltage	Frequency	Plug						
1	115/230V	50-60 HZ	110 - 120V US Plug, UL					\$ -	
2	115/230V	50-60 HZ	220 - 240V US Plug, UL					\$ -	
3	115/230V	50-60 HZ	220 - 240V DIN Plug, CE					\$ -	
5	115/230V	50-60 HZ	220 - 240V UK Plug, CE					\$ -	
6	115/230V	50-60 HZ	220 - 240V Aust/NZ Plug					\$ -	
	Liquid End	Head	Fittings	Balls	Seat / O-Ring	Connections	RPM Kit		
Machined FastPrime™									
	907NP	316SS	316SS	316SS	316SS / PTFE	1/4" NPT	RPM-907	\$ 526	
PD01	1	-907NP							

RPM Kit	Price	Contents
RPM-907	\$ 260	

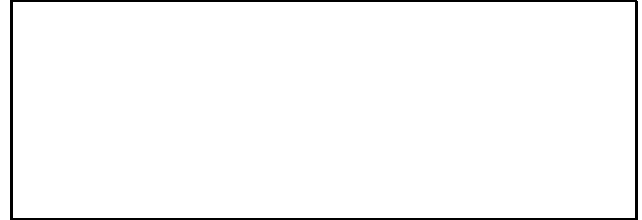

SERIES PD METERING PUMP SELECTION AND PRICING

OUTPUT CODE 4

160 SPM Max.

Size Code 2

0.68 GPH (2.6 LPH); 250 psi (17.0 bar)

Autoprime™ 0.20 GPH (0.76 LPH); 250 psi (17.0 bar)

PDx4							Price
Drive End							
Control							
PD04 Manual Control							\$ 315
PD74 Enhanced control with Pulse Input, Remote Stop/Start, and Tank Level Input							\$ 540
Power Code	Voltage	Frequency	Plug				
1	110/240V	50-60 HZ	110 - 120V US Plug, UL				\$ -
2	110/240V	50-60 HZ	220 - 240V US Plug, UL				\$ -
3	110/240V	50-60 HZ	220 - 240V DIN Plug, CE				\$ -
5	110/240V	50-60 HZ	220 - 240V UK Plug, CE				\$ -
6	110/240V	50-60 HZ	220 - 240V Aust/NZ Plug				\$ -
Liquid End	Head	Fittings	Balls	Seat / O-Ring		RPM Kit	
Molded FastPrime™							
822	PVDF	PVDF	Ceramic	PTFE / Polyprel®		RPM-822	\$ 275
823	PVDF	PVDF	Ceramic	PTFE / PTFE		RPM-823	\$ 316
828	PVC	PVC	Ceramic	PTFE / Polyprel®		RPM-822	\$ 232
Machined FastPrime™							
925	PP	PP	Ceramic	PTFE / Polyprel®		RPM-823	\$ 343
927*	316SS	316SS	316SS	316SS / PTFE		RPM-927	\$ 538
928	PVC	PVC	Ceramic	PTFE / Polyprel®		RPM-822	\$ 334
929	Acrylic	PVDF	PTFE	Polyprel®		RPM-929	\$ 353
920	Acrylic	PVC	Ceramic	PTFE / Polyprel®		RPM-822	\$ 340
AutoPrime™							
A28	PVC	PVC	Ceramic	PTFE / Polyprel®		RPM-A20A	\$ 334
A20	Acrylic	PVC	Ceramic	PTFE / Polyprel®		RPM-A20A	\$ 340
Valve Code	Compatible with		Valve				
S	FastPrime		4 Function Valve				\$ 64
N	FastPrime		-				\$ -
H	AutoPrime		4 Function Valve				\$ 127
A	AutoPrime		-				\$ 64
Connection Code							
I	Inch Tubing						\$ -
P	1/4" NPT (Only available with 316 SS Head & N Valve Code)						\$ -
PD04	1	- 822	S	I			

RPM Kit	Price	Contents
FastPrime™		
RPM-822	\$ 140	
RPM-823	\$ 160	
RPM-927	\$ 270	
RPM-929	\$ 140	
AutoPrime™		
RPM-A20A	\$ 170	

***NOTE:** 316SS Head only available with N FastPrime code and P Connection Code

SERIES PD METERING PUMP SELECTION AND PRICING

OUTPUT CODE 5

160 SPM Max.

Size Code 3

1.1 GPH (4.2 LPH); 150 psi (10.2 bar)

Autoprime™ 0.75 GPH (2.84 LPH); 110 psi (7.5 bar)

PDx5							Price
Drive End							Price
Control							Price
PD05 Manual Control							\$ 315
PD75 Enhanced Control with Pulse Input, Remote Stop/Start, and Tank Level Input							\$ 540
Power Code	Voltage	Frequency	Plug			Price	
1	110/240V	50-60 HZ	110 - 120V US Plug, UL			\$ -	
2	110/240V	50-60 HZ	220 - 240V US Plug, UL			\$ -	
3	110/240V	50-60 HZ	220 - 240V DIN Plug, CE			\$ -	
5	110/240V	50-60 HZ	220 - 240V UK Plug, CE			\$ -	
6	110/240V	50-60 HZ	220 - 240V Aust/NZ Plug			\$ -	
Liquid End	Head	Fittings	Balls	Seat / O-Ring	RPM Kit	Price	
Molded FastPrime™							
832	PVDF	PVDF	Ceramic	Polyprel®	RPM-832	\$ 275	
833	PVDF	PVDF	Ceramic	PTFE	RPM-833	\$ 316	
838	PVC	PVC	Ceramic	Polyprel®	RPM-832	\$ 232	
Machined FastPrime™							
935	PP	PP	Ceramic	PTFE	RPM-833	\$ 343	
937*	316SS	316SS	316SS	316SS / PTFE	RPM-937	\$ 538	
938	PVC	PVC	Ceramic	Polyprel®	RPM-832	\$ 334	
939	Acrylic	PVDF	PTFE	Polyprel®	RPM-939	\$ 353	
930	Acrylic	PVC	Ceramic	Polyprel®	RPM-832	\$ 340	
AutoPrime™							
A38	PVC	PVC	Ceramic	PTFE / Polyprel®	RPM-A30A	\$ 334	
A30	Acrylic	PVC	Ceramic	PTFE / Polyprel®	RPM-A30A	\$ 340	
Valve Code	Compatible with		Valve			Price	
S	FastPrime		4 Function Valve			\$ 64	
N	FastPrime		-			\$ -	
H	AutoPrime		4 Function Valve			\$ 127	
A	AutoPrime		-			\$ 64	
Connection Code							
I	Inch Tubing					\$ -	
P	1/4" NPT (Only available with 316 SS Head & N Valve Code)					\$ -	
PD05	1	- 832	S	I			

RPM Kit	Price	Contents
FastPrime™		
RPM-832	\$ 145	
RPM-833	\$ 170	
RPM-937	\$ 280	
RPM-939	\$ 145	
AutoPrime™		
RPM-A30A	\$ 180	

***NOTE:** 316SS Head only available with N FastPrime code and P Connection Code

SERIES PD METERING PUMP SELECTION AND PRICING

OUTPUT CODE 6

2.0 GPH (7.6 LPH); 70 psi (4.8 bar)

160 SPM Max.

Size Code 4

Autoprime™ 1.75 GPH (6.62 LPH); 50 psi (3.4 bar)

PDx6							Price
Drive End							
Control							
PD06 Manual Control							\$ 315
PD76 Enhanced control with Pulse Input, Remote Stop/Start, and Tank Level Input							\$ 540
Power Code	Voltage	Frequency	Plug				
1	110/240V	50-60 HZ	110 - 120V US Plug, UL			\$	-
2	110/240V	50-60 HZ	220 - 240V US Plug, UL			\$	-
3	110/240V	50-60 HZ	220 - 240V DIN Plug, CE			\$	-
5	110/240V	50-60 HZ	220 - 240V UK Plug, CE			\$	-
6	110/240V	50-60 HZ	220 - 240V Aust/NZ Plug			\$	-
Liquid End	Head	Fittings	Balls	Seat / O-Ring	RPM Kit		
Molded FastPrime™							
842	PVDF	PVDF	Ceramic	Polyprel®	RPM-842	\$	275
843	PVDF	PVDF	Ceramic	PTFE	RPM-843	\$	316
848	PVC	PVC	Ceramic	Polyprel®	RPM-842	\$	232
Machined FastPrime™							
945	PP	PP	Ceramic	PTFE	RPM-843	\$	343
947*	316SS	316SS	316SS	316SS / PTFE	RPM-947	\$	538
948	PVC	PVC	Ceramic	Polyprel®	RPM-842	\$	334
949	Acrylic	PVDF	PTFE	Polyprel®	RPM-949	\$	353
940	Acrylic	PVC	Ceramic	Polyprel®	RPM-842	\$	340
AutoPrime™							
A48	PVC	PVC	Ceramic	PTFE / Polyprel®	RPM-A40A	\$	334
A40	Acrylic	PVC	Ceramic	PTFE / Polyprel®	RPM-A40A	\$	340
Valve Code	Compatible with		Valve				
S	FastPrime		4 Function Valve			\$	64
N	FastPrime		-			\$	-
H	AutoPrime		4 Function Valve			\$	127
A	AutoPrime		-			\$	64
Connection Code							
I	Inch Tubing					\$	-
P	1/4" NPT (Only available with 316 SS Head & N Valve Code)					\$	-
PD06	1	- 842	S	I			

RPM Kit	Price	Contents
FastPrime™		
RPM-842	\$ 150	
RPM-843	\$ 180	
RPM-947	\$ 290	
RPM-949	\$ 150	
AutoPrime™		
RPM-A40A	\$ 190	

***NOTE:** 316SS Head only available with N FastPrime code and P Connection Code

EXCEL™ AD METERING PUMPS



For support:



Output Code	Max Output GPH	Max Output LPH	Max Pressure PSI	Max Pressure Bar
Excel™ AD with FastPrime™				
1	0.21	0.8	250	17.2
4	0.42	1.9	250	17.2
5	0.58	3.8	110	7.6
6	2.0	7.6	50	3.4
Excel™ AD with AutoPrime™				
1	0.15	0.6	250	17.2
4	0.33	1.2	250	17.2
5	0.80	3.0	110	7.6
6	1.80	6.8	50	3.4

Control Codes

Key Features	AD2	AD8	AD9
Stroke length manually adjustable	✓	✓	✓
Stroke frequency manually adjustable	✓	✓	✓
Low level indication	✓	✓	✓
Display of calculated flow rate	✓	✓	✓
Pulse or 4/20 mA signal input controls frequency		✓	✓
Pulse multiply/divide functions		✓	✓
24 V output for remote device		✓	✓
Dual low-level float switch input		✓	✓
Remote on/off signal input			✓
Outputs include: 4-20mA, pulse, Alarm			✓
Remote internal/external mode input			✓
Remote alarm transfer			✓

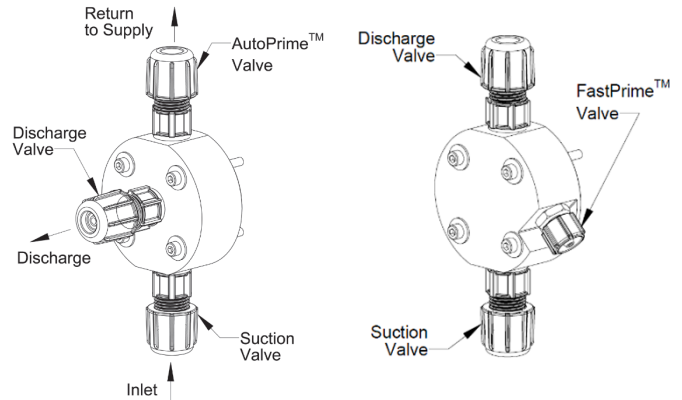

AutoPrime™
Allows for the constant removal of vapors and gases present in applications like sodium hypochlorite and hydrogen peroxide.

FastPrime™
Has an integral manual priming valve to facilitate quick pump start-up.



4 Function Valve

- This diaphragm type, anti-syphon/pressure relief valve is installed on the pump head.
- Can be oriented as required (360°) at precisely the desired position.
- Easier to use thanks to the more user-friendly design of the priming knobs and back pressure valve

What's in the Box

Excel AD units include:						AD9 units include:	
						Certain AD8 units include:	
Tube Connection Hardware	Quick Start Guide	Suction/Discharge Tubing	Injection Check Valve	Foot Valve	Ceramic Weight		
Stainless Steel LE units						5-pin Control Cable	6-pin Control Cable

EXCEL AD METERING PUMP SELECTION AND PRICING

OUTPUT CODE 1

120 SPM Max.

Size Code 1

0.002 to 0.21 GPH (0.01 to 0.8 LPH); 250 psi (17.2 bar) **Autoprime™** 0.0015 to 0.15 GPH (0.006 to 0.6 LPH)

ADx1

Drive End								Price
Control								
AD21 Dual Manual Control								\$ 663
AD81 Pulse/Analog Input w/ Dual Manual Control								\$ 857
AD91 Pulse/Analog Input w/ Dual Manual Control - Advanced Features								\$ 1,084
Power Code	Voltage	Frequency	Plug					
1	110/240V	50-60 HZ	110 - 120V US Plug					\$ -
2	220/240V	50-60 HZ	220 - 240V US Plug					\$ -
3	220/240V	50-60 HZ	220 - 240V DIN Plug					\$ -
5	220/240V	50-60 HZ	220 - 240V UK Plug					\$ -
6	220/240V	50-60 HZ	220 - 240V Aust/NZ Plug					\$ -
Liquid End	Head	Fittings	Balls	Seat / O-Ring	Tubing & Connections		RPM Kit	
Machined FastPrime™								
910	Acrylic	PVC	Ceramic	PTFE/Polyprel®	PE 1/4" O.D.		RPM-812	\$ 328
915	PP	PP	Ceramic	PTFE	PE 1/4" O.D.		RPM-813	\$ 331
918	PVC	PVC	Ceramic	PTFE/Polyprel®	PE 1/4" O.D.		RPM-812	\$ 322
919	Acrylic	PVDF	PTFE	Polyprel®	PE 1/4" O.D.		RPM-919	\$ 341
917*	316SS	316SS	316SS	316SS/PTFE	1/4" NPT		RPM-917	\$ 526
Molded FastPrime™								
812	PVDF	PVDF	Ceramic	PTFE/Polyprel®	PE 1/4" O.D.		RPM-812	\$ 263
813	PVDF	PVDF	Ceramic	PTFE	PE 1/4" O.D.		RPM-813	\$ 304
818	PVC	PVC	Ceramic	PTFE/Polyprel®	PE 1/4" O.D.		RPM-812	\$ 220
AutoPrime™								
A10	Acrylic	PVC	Ceramic	PTFE/Polyprel®	PE 1/4" O.D.		RPM-A10A	\$ 328
A18	PVC	PVC	Ceramic	PTFE/Polyprel®	PE 1/4" O.D.		RPM-A10A	\$ 322
Valve Code	Compatible with			Valve				
S	FastPrime™			4 Function Valve			\$ 64	
N	FastPrime™			-			-	
H	AutoPrime™			4 Function Valve			\$ 127	
A	AutoPrime™			-			\$ 64	
Connection Code								
I	Inch Tube connections with tubing - also includes 1/2" NPT and 1/2" BSP connection.							\$ -
P	1/4" NPT (Only available with 316 SS Head & N Valve Code)							\$ -
AD21	1	- 910	S	I				

RPM Kit	Price	Contents
FastPrime™		
RPM-812	\$ 135	*O Rings *Shaft Seal *Liquifram *Check Valve Cartridges *Injection Valve Cartridge *FastPrime or AutoPrime Cartridge
RPM-813	\$ 150	
RPM-919	\$ 135	
RPM-917	\$ 260	
RPM-812	\$ 135	
RPM-813	\$ 150	
AutoPrime™		
RPM-A10A	\$ 160	

***NOTE:** 316SS Head only available with N Valve Code and P Connection Code

EXCEL AD METERING PUMP SELECTION AND PRICING

OUTPUT CODE 4

120 SPM Max.

Size Code 2

0.005 to 0.5 GPH (0.02 to 1.9 LPH); 250 psi (17.2 bar)

Autoprime™ 0.0033 to 0.33 GPH (0.012 to 1.2 LPH)

ADx4

Drive End								Price
Control								
AD24 Dual Manual Control								\$ 663
AD84 Pulse/Analog Input w/ Dual Manual Control								\$ 857
AD94 Pulse/Analog Input w/ Dual Manual Control - Advanced Features								\$ 1,084
Power Code	Voltage		Frequency		Plug			
1	110/240V		50-60 HZ		110 - 120V US Plug			\$ -
2	220/240V		50-60 HZ		220 - 240V US Plug			\$ -
3	220/240V		50-60 HZ		220 - 240V DIN Plug			\$ -
5	220/240V		50-60 HZ		220 - 240V UK Plug			\$ -
6	220/240V		50-60 HZ		220 - 240V Aust/NZ Plug			\$ -
Liquid End	Head	Fittings	Balls	Seat / O-Ring	Tubing & Connections		RPM Kit	
Machined FastPrime™								
920	Acrylic	PVC	Ceramic	PTFE/Polyprel®	PE 1/4" O.D.		RPM-822	\$ 340
925	PP	PP	Ceramic	PTFE	PE 1/4" O.D.		RPM-823	\$ 343
928	PVC	PVC	Ceramic	PTFE/Polyprel®	PE 1/4" O.D.		RPM-822	\$ 334
929	Acrylic	PVDF	PTFE	Polyprel®	PE 1/4" O.D.		RPM-929	\$ 353
927*	316SS	316SS	316SS	316SS/PTFE	1/4" NPT		RPM-927	\$ 538
Molded FastPrime™								
822	PVDF	PVDF	Ceramic	PTFE/Polyprel®	PE 1/4" O.D.		RPM-822	\$ 275
823	PVDF	PVDF	Ceramic	PTFE	PE 1/4" O.D.		RPM-823	\$ 316
828	PVC	PVC	Ceramic	PTFE/Polyprel®	PE 1/4" O.D.		RPM-822	\$ 232
AutoPrime™								
A20	Acrylic	PVC	Ceramic	PTFE/Polyprel®	PE 1/4" O.D.		RPM-A20A	\$ 340
A28	PVC	PVC	Ceramic	PTFE/Polyprel®	PE 1/4" O.D.		RPM-A20A	\$ 334
High Viscosity								
624	PP	PP	316SS	PTFE	PE 0.5 O.D. / Vinyl 0.938 O.D.		RPM-624	\$ 416
626	Acrylic	PP	316SS	PTFE	PE 0.5 O.D. / Vinyl 0.938 O.D.		RPM-626	\$ 413
Valve Code	Compatible with			Valve				
S	FastPrime™			4 Function Valve			\$ 64	
N	FastPrime™			-			\$ -	
H	AutoPrime™			4 Function Valve			\$ 127	
A	AutoPrime™			-			\$ 64	
V	High Viscosity Heads only			-			\$ -	
P	Ported Head	High Viscosity Heads only		-			\$ 25	
Connection Code								
I	Inch Tube connections with tubing - also includes 1/2" NPT and 1/2" BSP connection.							\$ -
P	1/4" NPT (Only available with 316 SS Head & N Valve Code)							\$ -
AD24	1	- 920	S	I				

RPM Kit	Price	Contents
FastPrime™		
RPM-822	\$ 140	*O Rings
RPM-823	\$ 160	*Shaft Seal
RPM-929	\$ 140	*Liquifram
RPM-927	\$ 270	*Check Valve Cartridges
AutoPrime™		
RPM-A20A	\$ 170	*Injection Valve Cartridge
		*FastPrime or AutoPrime Cartridge
High Viscosity		
RPM-624	\$ 130	*Clamp Rings *Liquifram
RPM-626	\$ 130	*Seal Ring Seats *Balls, Springs
		*Shaft Seal

***NOTE:** 316SS Head only available with N Valve Code and P Connection Code

EXCEL AD METERING PUMP SELECTION AND PRICING

OUTPUT CODE 5

120 SPM Max.

Size Code 3

0.01 to 1.0 GPH (0.04 to 3.8 LPH); 110 psi (7.6 bar)

Autoprime™ 0.008 to 0.8 GPH (0.03 to 3.0 LPH)

ADx5

Drive End							Price	
Control								
AD25 Dual Manual Control							\$ 663	
AD85 Pulse/Analog Input w/ Dual Manual Control							\$ 857	
AD95 Pulse/Analog Input w/ Dual Manual Control - Advanced Features							\$ 1,084	
Power Code	Voltage		Frequency		Plug			
1	110/240V		50-60 HZ		110 - 120V US Plug		\$ -	
2	220/240V		50-60 HZ		220 - 240V US Plug		\$ -	
3	220/240V		50-60 HZ		220 - 240V DIN Plug		\$ -	
5	220/240V		50-60 HZ		220 - 240V UK Plug		\$ -	
6	220/240V		50-60 HZ		220 - 240V Aust/NZ Plug		\$ -	
	Liquid End	Head	Fittings	Balls	Seat / O-Ring	Tubing & Connections Suction / Discharge	RPM Kit	
Machined FastPrime™								
	930	Acrylic	PVC	Ceramic	Polyprel®	PE 3/8" O.D.	RPM-832	\$ 340
	935	PP	PP	Ceramic	PTFE	PE 3/8" O.D.	RPM-833	\$ 343
	938	PVC	PVC	Ceramic	Polyprel®	PE 3/8" O.D.	RPM-832	\$ 334
	939	Acrylic	PVDF	PTFE	Polyprel®	PE 3/8" O.D.	RPM-939	\$ 353
	937*	316SS	316SS	316SS	316SS/PTFE	1/4" NPT	RPM-937	\$ 538
Molded FastPrime™								
	832	PVDF	PVDF	Ceramic	Polyprel®	PE 3/8" O.D.	RPM-832	\$ 275
	833	PVDF	PVDF	Ceramic	PTFE	PE 3/8" O.D.	RPM-833	\$ 316
	838	PVC	PVC	Ceramic	Polyprel®	PE 3/8" O.D.	RPM-832	\$ 232
AutoPrime™								
	A30	Acrylic	PVC	Ceramic	PTFE/Polyprel®	PE 3/8" O.D.	RPM-A30A	\$ 340
	A38	PVC	PVC	Ceramic	PTFE/Polyprel®	PE 3/8" O.D.	RPM-A30A	\$ 334
High Viscosity								
	634	PP	PP	316SS	PTFE	PE 0.5 O.D. / Vinyl 0.938 O.D.	RPM-634	\$ 416
	636	Acrylic	PP	316SS	PTFE	PE 0.5 O.D. / Vinyl 0.938 O.D.	RPM-636	\$ 413
	Valve Code	Compatible with			Valve			
	S	FastPrime™			4 Function Valve		\$ 64	
	N	FastPrime™			-		\$ -	
	H	AutoPrime™			4 Function Valve		\$ 127	
	A	AutoPrime™			-		\$ 64	
	V	High Viscosity Heads only			-		\$ -	
	P	Ported Head High Viscosity Heads only			-		\$ 25	
	Connection Code							
	I	Inch Tube connections with tubing - also includes 1/2" NPT and 1/2" BSP connection.						\$ -
	P	1/4" NPT (Only available with 316 SS Head & N Valve Code)						\$ -
AD25	1	- 930	S	I				

RPM Kit	Price	Contents
FastPrime™		
RPM-832	\$ 145	*O Rings
RPM-833	\$ 170	*Shaft Seal
RPM-939	\$ 145	*Liquifram
RPM-937	\$ 280	*Check Valve Cartridges
AutoPrime™		
RPM-A30A	\$ 180	*Injection Valve Cartridge
		*FastPrime or AutoPrime Cartridge
High Viscosity		
RPM-634	\$ 140	*Clamp Rings *Liquifram
RPM-636	\$ 140	*Seal Ring Seats *Balls, Springs
		*Shaft Seal

***NOTE:** 316SS Head only available with N Valve Code and P Connection Code

EXCEL AD METERING PUMP SELECTION AND PRICING

OUTPUT CODE 6

120 SPM Max.

Size Code 4

0.02 to 2.0 GPH (0.08 to 7.6 LPH); 50 psi (3.4 bar)

Autoprime™ 0.018 to 1.8 GPH (0.068 to 6.8 LPH)**ADx6**

Drive End							Price	
Control								
AD26 Dual Manual Control							\$ 699	
AD86 Pulse/Analog Input w/ Dual Manual Control							\$ 893	
AD96 Pulse/Analog Input w/ Dual Manual Control - Advanced Features							\$ 1,120	
Power Code	Voltage		Frequency		Plug			
1	110/240V		50-60 HZ		110 - 120V US Plug		\$ -	
2	220/240V		50-60 HZ		220 - 240V US Plug		\$ -	
3	220/240V		50-60 HZ		220 - 240V DIN Plug		\$ -	
5	220/240V		50-60 HZ		220 - 240V UK Plug		\$ -	
6	220/240V		50-60 HZ		220 - 240V Aust/NZ Plug		\$ -	
Liquid End	Head	Fittings	Balls	Seat / O-Ring	Tubing & Connections Suction / Discharge	RPM Kit		
Machined FastPrime™								
940	Acrylic	PVC	Ceramic	Polyprel®	PE 3/8" O.D.	RPM-842	\$ 340	
945	PP	PP	Ceramic	PTFE	PE 3/8" O.D.	RPM-843	\$ 343	
948	PVC	PVC	Ceramic	Polyprel®	PE 3/8" O.D.	RPM-842	\$ 334	
949	Acrylic	PVDF	PTFE	Polyprel®	PE 3/8" O.D.	RPM-949	\$ 353	
947*	316SS	316SS	316SS	316SS/PTFE	1/4" NPT	RPM-947	\$ 538	
Molded FastPrime™								
842	PVDF	PVDF	Ceramic	Polyprel®	PE 3/8" O.D.	RPM-842	\$ 275	
843	PVDF	PVDF	Ceramic	PTFE	PE 3/8" O.D.	RPM-843	\$ 316	
848	PVC	PVC	Ceramic	Polyprel®	PE 3/8" O.D.	RPM-842	\$ 232	
AutoPrime™								
A40	Acrylic	PVC	Ceramic	PTFE/Polyprel®	PE 3/8" O.D.	RPM-A40A	\$ 340	
A48	PVC	PVC	Ceramic	PTFE/Polyprel®	PE 3/8" O.D.	RPM-A40A	\$ 334	
High Viscosity								
644	PP	PP	316SS	PTFE	PE 0.5 O.D. / Vinyl 0.938 O.D.	RPM-644	\$ 416	
646	Acrylic	PP	316SS	PTFE	PE 0.5 O.D. / Vinyl 0.938 O.D.	RPM-646	\$ 413	
Valve Code	Compatible with			Valve				
S	FastPrime™			4 Function Valve		\$ 64		
N	FastPrime™			-		\$ -		
H	AutoPrime™			4 Function Valve		\$ 127		
A	AutoPrime™			-		\$ 64		
V	High Viscosity Heads only			-		\$ -		
P	Ported Head High Viscosity Heads only			-		\$ 25		
Connection Code								
I	Inch Tube connections with tubing - also includes 1/2" NPT and 1/2" BSP connection.						\$ -	
P	1/4" NPT (Only available with 316 SS Head & N Valve Code)						\$ -	
AD26	1	- 940	S	I				

RPM Kit	Price	Contents
FastPrime™		
RPM-842	\$ 150	*O Rings
RPM-843	\$ 180	*Shaft Seal
RPM-949	\$ 150	*Liquifram
RPM-947	\$ 290	*Check Valve Cartridges
AutoPrime™		
RPM-A40A	\$ 190	*Injection Valve Cartridge
High Viscosity		
RPM-644	\$ 150	*FastPrime or AutoPrime Cartridge
RPM-646	\$ 150	*Clamp Rings *Liquifram
		*Seal Ring Seats *Balls, Springs
		*Shaft Seal

***NOTE:** 316SS Head only available with N Valve Code and P Connection Code

SERIES B METERING PUMPS



For support:



Output Code	Max Output GPH	Max Output LPH	Max Pressure PSI	Max Pressure Bar
Series B with Liquipro™				
1	1.6	6.1	150	10.3
2	2.5	9.5	100	6.9
3	4.5	17.0	50	3.4
4	7.0	26.5	30	2.07
Series B with AutoPrime™				
1	1.4	5.3	150	10.3
2	2.3	8.7	100	6.9
3	4.0	15.1	50	3.4
4	6.8	25.7	30	2.07

Control Codes

Key Features	B1	B7	B9
Stroke length manually adjustable	✓	✓	✓
Stroke frequency manually adjustable	✓	✓	✓
External control via pulse input		✓	
Manual/External mode selection		✓	✓
LCD and 4-key tactile keypad			✓
External control via 4-20mA			✓
Divide/Multiply incoming pulses			✓
Flow monitoring with alarm*			✓

*Available with LMI Digi-Pulse™ Flow Monitor

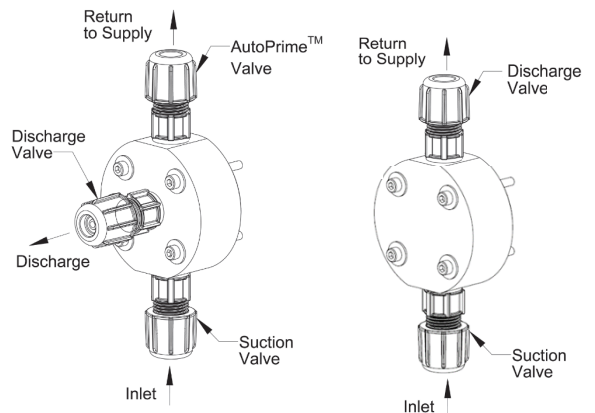

AutoPrime™

Allows for the constant removal of vapors and gases present in applications like sodium hypochlorite and hydrogen peroxide.

Liquipro™

Standard Liquid End suitable for most applications



4 Function Valve

- This diaphragm type, anti-syphon/pressure relief valve is installed on the pump head.
- Can be oriented as required (360°) at precisely the desired position.
- Easier to use thanks to the more user-friendly design of the priming knobs and back pressure valve

What's in the Box

Series B units include:						B9 units include:	
<p>Tube Connection Hardware</p>	<p>Quick Start Guide</p>	<p>Suction/Discharge Tubing</p>	<p>Injection Check Valve</p>	<p>Foot Valve</p>	<p>Ceramic Weight</p>	<p>Certain B7 units include:</p> <p>4-pin Control Cable</p>	<p>8-pin Control Cable</p>

Stainless Steel LE units

SERIES B PUMP SELECTION AND PRICING

OUTPUT CODE 1

Size Code 0.9

0.0 - 1.6 GPH (0.0 - 6.1 LPH); 150 psi (10.3 bar) **AutoPrime™** estimated at 0.00 to 1.4 GPH (0.00 to 5.3 LPH)

Bx1							Price
Drive End							
Control							
B11 Dual Manual Control							\$ 859
B71 Pulse Input w/ Dual Manual Control							\$ 964
B91 Pulse/Analog Input w/ Dual Manual Control - Advanced Features							\$ 1,300
Power Code	Voltage	Frequency	Plug				
1	110/240V	50-60 HZ	110 - 120V US Plug				\$ -
2	220/240V	50-60 HZ	220 - 240V US Plug				\$ -
3	220/240V	50-60 HZ	220 - 240V DIN Plug				\$ -
5	220/240V	50-60 HZ	220 - 240V UK Plug				\$ -
6	220/240V	50-60 HZ	220 - 240V Aust/NZ Plug				\$ -
Liquid End	Head	Fittings	Balls	Cartridge Valve or Seal Rings		RPM Kit	
Liquipro™							
392	PVDF	PVDF	Ceramic	PVDF / Polyprel®		RPM-392/398	\$ 276
393	PVDF	PVDF	Ceramic	PVDF / PTFE		RPM-393	\$ 317
398	PVC	PVC	Ceramic	PVDF/ Polyprel®		RPM-392/398	\$ 233
490	Acrylic	PVC	Ceramic	PVDF/ Polyprel®		RPM-392/398	\$ 341
495	PP	PP	Ceramic	PTFE		RPM-495	\$ 344
498	PVC	PVC	Ceramic	PVDF/ Polyprel®		RPM-392/398	\$ 335
499	Acrylic	PVDF	PTFE	PVDF/ Polyprel®		RPM-490F	\$ 354
LMI							
85	PP	PP	316SS	PTFE		SP-85HV	\$ 430
86	Acrylic	PP	316SS	FKM		SP-86	\$ 430
297		316SS	316SS	316SS		-	\$ 539
AutoPrime™							
D90	Acrylic	PVC	Ceramic	Polyprel®		RPM-D98	\$ 341
D98	PVC	PVC	Ceramic	Polyprel®		RPM-D98	\$ 335
Valve & Connection Code	Compatible with		Valve	Tubing & Connections Suction / Discharge			
SI	Liquipro™		4FV	PE 3/8" O.D.			\$ 64
TI	Liquipro™		3FV	PE 3/8" O.D.			\$ -
NI	Liquipro™		-	PE 3/8" O.D.			\$ -
HV	LMI Heads only		-	PE 0.5" O.D. / Vinyl 0.938" O.D.			\$ -
-	316SS LMI Head only		-	Pipe 1/4" NPT M			\$ -
HI	AutoPrime™		4FV	PE 3/8" O.D.			\$ 127
AI	AutoPrime™		-	PE 3/8" O.D.			\$ 64
B11	1	-392	SI				

RPM Kit	Price	Contents
Liquipro™		
RPM-392/398	\$ 140	*O-Rings
RPM-393	\$ 160	*Shaft Seal
RPM-495	\$ 145	*Check Valve Cartridges
RPM-490F	\$ 145	*Hardware kit
		*Liquifram
LMI		
SP-85HV	\$ 160	*Shaft Seal *Liquifram
SP-86	\$ 150	*Seal Ring Seats *Clamp rings
		*Balls & springs
AutoPrime™		
RPM-D98	\$ 170	*O Rings *Check Valve Cartridges
		*Shaft Seal *Injection Valve Cartridge
		*Liquifram *AutoPrime Cartridge



SERIES B PUMP SELECTION AND PRICING

OUTPUT CODE 2

Size Code 0.9

0.0 - 2.5 GPH (0.0 - 9.5 LPH); 100 psi (6.9 bar)

AutoPrime™ estimated at 0.00 to 2.3 GPH (0.00 to 8.7 LPH)

Bx2							Price
Drive End							
Control							
B12 Dual Manual Control							\$ 859
B72 Pulse Input w/ Dual Manual Control							\$ 964
B92 Pulse/Analog Input w/ Dual Manual Control - Advanced Features							\$ 1,300
Power Code	Voltage	Frequency	Plug				
1	110/240V	50-60 HZ	110 - 120V US Plug				\$ -
2	220/240V	50-60 HZ	220 - 240V US Plug				\$ -
3	220/240V	50-60 HZ	220 - 240V DIN Plug				\$ -
5	220/240V	50-60 HZ	220 - 240V UK Plug				\$ -
6	220/240V	50-60 HZ	220 - 240V Aust/NZ Plug				\$ -
Liquid End	Head	Fittings	Balls	Cartridge Valve or Seal Rings		RPM Kit	
Liquipro™							
392	PVDF	PVDF	Ceramic	PVDF / Polyprel®		RPM-392/398	\$ 276
393	PVDF	PVDF	Ceramic	PVDF / PTFE		RPM-393	\$ 317
398	PVC	PVC	Ceramic	PVDF / Polyprel®		RPM-392/398	\$ 233
490	Acrylic	PVC	Ceramic	PVDF / Polyprel®		RPM-392/398	\$ 341
495	PP	PP	Ceramic	PTFE		RPM-495	\$ 344
498	PVC	PVC	Ceramic	PVDF / Polyprel®		RPM-392/398	\$ 335
499	Acrylic	PVDF	PTFE	PVDF / Polyprel®		RPM-490F	\$ 354
LMI							
85	PP	PP	316SS	PTFE		SP-85HV	\$ 430
86	Acrylic	PP	316SS	FKM		SP-86	\$ 430
297		316SS	316SS	316SS		-	\$ 539
AutoPrime™							
D90	Acrylic	PVC	Ceramic	Polyprel®		RPM-D98	\$ 341
D98	PVC	PVC	Ceramic	Polyprel®		RPM-D98	\$ 335
Valve & Connection Code	Compatible with		Valve	Tubing & Connections Suction / Discharge			
SI	Liquipro™		4FV	PE 3/8" O.D.			\$ 64
TI	Liquipro™		3FV	PE 3/8" O.D.			\$ -
NI	Liquipro™		-	PE 3/8" O.D.			\$ -
HV	LMI Heads only		-	PE 0.5" O.D. / Vinyl 0.938" O.D.			\$ -
-	316SS LMI Head only		-	Pipe 1/4" NPT M			\$ -
HI	AutoPrime™		4FV	PE 3/8" O.D.			\$ 127
AI	AutoPrime™		-	PE 3/8" O.D.			\$ 64
B12	1	-392	SI				

RPM Kit	Price	Contents
Liquipro™		
RPM-392/398	\$ 140	*O-Rings
RPM-393	\$ 160	*Shaft Seal
RPM-495	\$ 145	*Check Valve Cartridges
RPM-490F	\$ 145	*Hardware kit
		*Liquifram
		*Injection Valve Cartridge
LMI		
SP-85HV	\$ 160	*Shaft Seal *Liquifram
SP-86	\$ 150	*Seal Ring Seats *Clamp rings
		*Balls & springs
AutoPrime™		
RPM-D98	\$ 170	*O Rings *Check Valve Cartridges
		*Shaft Seal *Injection Valve Cartridge
		*Liquifram *AutoPrime Cartridge



SERIES B PUMP SELECTION AND PRICING

OUTPUT CODE 3

Size Code 1.8

0.0 - 4.5 GPH (0.0 - 17 LPH); 50 psi (3.4 bar)

AutoPrime™ estimated at 0.00 to 4.0 GPH (0.00 to 15.1 LPH)

Bx3 Drive End							Price
Control							
B13 Dual Manual Control							\$ 859
B73 Pulse Input w/ Dual Manual Control							\$ 964
B93 Pulse/Analog Input w/ Dual Manual Control - Advanced Features							\$ 1,300
Power Code	Voltage	Frequency	Plug				
1	110/240V	50-60 HZ	110 - 120V US Plug				\$ -
2	220/240V	50-60 HZ	220 - 240V US Plug				\$ -
3	220/240V	50-60 HZ	220 - 240V DIN Plug				\$ -
5	220/240V	50-60 HZ	220 - 240V UK Plug				\$ -
6	220/240V	50-60 HZ	220 - 240V Aust/NZ Plug				\$ -
Liquid End	Head	Fittings	Balls	Cartridge Valve or Seal Rings		RPM Kit	
Liquipro™							
362	PVDF	PVDF	Ceramic	PVDF / Polyprel®		RPM-362/368	\$ 276
363	PVDF	PVDF	Ceramic	PVDF / PTFE		RPM-363	\$ 317
368	PVC	PVC	Ceramic	PVDF / Polyprel®		RPM-362/368	\$ 233
460	Acrylic	PVC	Ceramic	PVDF / Polyprel®		RPM-362/368	\$ 341
465	PP	PP	Ceramic	PTFE		RPM-465	\$ 344
468	PVC	PVC	Ceramic	PVDF / Polyprel®		RPM-362/368	\$ 335
469	Acrylic	PVDF	PTFE	PVDF / Polyprel®		RPM-460F	\$ 354
LMI							
75	PP	PP	316SS	PTFE		SP-75HV	\$ 430
76	Acrylic	PP	316SS	FKM		SP-76	\$ 430
277		316SS	316SS	316SS		-	\$ 539
AutoPrime™							
D60	Acrylic	PVC	Ceramic	Polyprel®		RPM-D68	\$ 341
D68	PVC	PVC	Ceramic	Polyprel®		RPM-D68	\$ 335
Valve & Connection Code	Compatible with		Valve	Tubing & Connections Suction / Discharge			
SI	Liquipro™		4FV	PE 3/8" O.D.			\$ 64
TI	Liquipro™		3FV	PE 3/8" O.D.			\$ -
NI	Liquipro™		-	PE 3/8" O.D.			\$ -
HV	LMI Heads only		-	PE 0.5" O.D. / Vinyl 0.938" O.D.			\$ -
-	316SS LMI Head only		-	Pipe 1/4" NPT M			\$ -
HI	AutoPrime™		4FV	PE 3/8" O.D.			\$ 127
AI	AutoPrime™		-	PE 3/8" O.D.			\$ 64
B13	1	-362	SI				

RPM Kit	Price	Contents
Liquipro™		
RPM-362/368	\$ 145	*O-Rings
RPM-363	\$ 170	*Shaft Seal
RPM-465	\$ 155	*Check Valve Cartridges
RPM-460F	\$ 155	*Hardware kit
		*Liquifram
		*Injection Valve Cartridge
LMI		
SP-75HV	\$ 160	*Shaft Seal *Liquifram
SP-76	\$ 150	*Seal Ring Seats *Clamp rings
		*Balls & springs
AutoPrime™		
RPM-D68	\$ 180	*O Rings *Check Valve Cartridges
		*Shaft Seal *Injection Valve Cartridge
		*Liquifram *AutoPrime Cartridge



SERIES B PUMP SELECTION AND PRICING

OUTPUT CODE 4

Size Code 3.0

0.0 - 7.0 GPH (0.0 - 26.5 LPH); 30 psi (2.07 bar) **AutoPrime™** estimated at 0.00 to 6.8 GPH (0.00 to 25.7 LPH)

Bx4 Drive End							Price
Control							
B14 Dual Manual Control							\$ 918
B74 Pulse Input w/ Dual Manual Control							\$ 1,023
B94 Pulse/Analog Input w/ Dual Manual Control - Advanced Features							\$ 1,359
Power Code	Voltage	Frequency	Plug				
1	110/240V	50-60 HZ	110 - 120V US Plug				\$ -
2	220/240V	50-60 HZ	220 - 240V US Plug				\$ -
3	220/240V	50-60 HZ	220 - 240V DIN Plug				\$ -
5	220/240V	50-60 HZ	220 - 240V UK Plug				\$ -
6	220/240V	50-60 HZ	220 - 240V Aust/NZ Plug				\$ -
Liquid End	Head	Fittings	Balls	Cartridge Valve or Seal Rings		RPM Kit	
Liquipro™							
312	PVDF	PVDF	Ceramic	PVDF / Polyprel®		RPM-312/318	\$ 386
313	PVDF	PVDF	Ceramic	PVDF / PTFE		RPM-313	\$ 427
318	PVC	PVC	Ceramic	PVDF/ Polyprel®		RPM-312/318	\$ 343
410	Acrylic	PVC	Ceramic	PVDF/ Polyprel®		RPM-312/318	\$ 451
415	PP	PP	Ceramic	PTFE		RPM-415	\$ 454
418	PVC	PVC	Ceramic	PVDF/ Polyprel®		RPM-312/318	\$ 445
419	Acrylic	PVDF	PTFE	PVDF/ Polyprel®		RPM-410F	\$ 464
LMI							
217	316SS	316SS	316SS	316SS		-	\$ 539
AutoPrime™							
D10	Acrylic	PVC	Ceramic	Polyprel®		RPM-D18	\$ 451
D18	PVC	PVC	Ceramic	Polyprel®		RPM-D18	\$ 445
Valve & Connection Code	Compatible with		Valve	Tubing & Connections			
SI	Liquipro™		4FV	PE 0.5" O.D.		\$ 64	
TI	Liquipro™		3FV	PE 0.5" O.D.		\$ -	
NI	Liquipro™		-	PE 0.5" O.D.		\$ -	
-	316SS LMI Head only		-	Pipe 1/4" NPT M		\$ -	
HI	AutoPrime™		4FV	PE 0.5" O.D.		\$ 127	
AI	AutoPrime™		-	PE 0.5" O.D.		\$ 64	
B14	1	- 312	SI				

RPM Kit	Price	Contents
Liquipro™		
RPM-312/318	\$ 150	*O-Rings
RPM-313	\$ 180	*Shaft Seal
RPM-415	\$ 165	*Check Valve Cartridges
RPM-410F	\$ 165	*Hardware kit
		*Liquifram
		*Injection Valve Cartridge
AutoPrime™		
RPM-D18	\$ 190	*O Rings
		*Check Valve Cartridges
		*Shaft Seal
		*Injection Valve Cartridge
		*Liquifram
		*AutoPrime Cartridge

NOTE: Liquipro™ Liquid Ends use 3/8" diameter valve balls. Pump output may be reduced in some applications.

SERIES C METERING PUMPS



For support:



Output Code	Max Output GPH	Max Output LPH	Max Pressure PSI	Max Pressure Bar
Series C with Liquipro™				
0	1.3	4.9	300	20.7
1	2.5	9.5	150	10.3
2	4.0	15.1	100	6.9
3	8.0	30.3	60	4.1
4	20.0	75.7	25	1.7
6	4.0	15.1	175	12.1
7	10.0	38.0	80	5.5
8	25.0	95.0	30	2.07
Series C with AutoPrime™				
1	2.3	8.7	150	10.3
2	3.8	14.4	100	6.9
3	7.8	29.5	60	4.1

Control Codes

Key Features	C1	C7	C9
Stroke length manually adjustable	✓	✓	✓
Stroke frequency manually adjustable	✓	✓	✓
External control via pulse input		✓	✓
Manual/External mode selection		✓	✓
LCD and 4-key tactile keypad			✓
External control via 4-20mA			✓
Divide/Multiply incoming pulses			✓
Flow monitoring with alarm*			✓

*Available with LMI Digi-Pulse™ Flow Monitor



4 Function Valve

- This diaphragm type, anti-syphon/pressure relief valve is installed on the pump head.
- Can be oriented as required (360°) at precisely the desired position.
- Easier to use thanks to the more user-friendly design of the priming knobs and back pressure valve

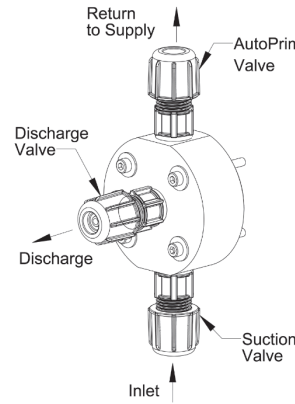

AutoPrime™

Allows for the constant removal of vapors and gases present in applications like sodium hypochlorite and hydrogen peroxide.

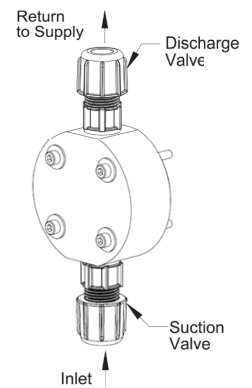

Liquipro™

Standard Liquid End suitable for most applications

What's in the Box

Series C units include:						C9 units include:	
						Certain C7 units include:	
Tube Connection Hardware	Quick Start Guide	Suction/Discharge Tubing	Injection Check Valve	Foot Valve	Ceramic Weight		
Stainless Steel LE units						4-pin Control Cable	8-pin Control Cable

SERIES C PUMP SELECTION AND PRICING

OUTPUT CODE 0

Size Code 0.9

0.0 - 1.3 GPH (0.0 - 4.9 LPH); 300 psi (20.7 bar)

Cx0										
Drive End									Price	
Control										
C10 Dual Manual Control									\$ 1,236	
C70 Pulse Input w/ Dual Manual Control									\$ 1,337	
C90 Pulse/Analog Input w/ Dual Manual Control - Advanced Features									\$ 1,688	
Power Code	Voltage			Frequency		Plug				
1	110/240V			50-60 HZ		110 - 120V US Plug				
2	220/240V			50-60 HZ		220 - 240V US Plug				
3	220/240V			50-60 HZ		220 - 240V DIN Plug				
5	220/240V			50-60 HZ		220 - 240V UK Plug				
6	220/240V			50-60 HZ		220 - 240V Aust/NZ Plug				
	Liquid End	Valve	Head	Fittings	Balls	Seal Ring	Tubing & Connections		RPM Kit	
Liquipro™										
	498SP	4FV	PVC	PVC	Ceramic	PVDF/Polyprel®	Pipe 0.5" NPT M	RPM-392/398	\$ 399	
	498TP	3FV	PVC	PVC	Ceramic	PVDF/Polyprel®	Pipe 0.5" NPT M	RPM-392/398	\$ 335	
LMI										
	297	-	316SS	316SS	316SS	316SS	Pipe 1/4" NPT M	-	\$ 539	
C10	1	-498SP								

RPM Kit	Price	Contents
Liquipro™		
RPM-392/398	\$ 140	*O-Rings *Shaft Seal *Check Valve Cartridges *Hardware kit *Liquifram



SERIES C PUMP SELECTION AND PRICING

OUTPUT CODE 1

Size Code 1.8

0.0 - 2.5 GPH (0.0 - 9.5 LPH); 150 psi (10.3 bar) **AutoPrime™** estimated at 0.00 to 2.3 GPH (0.00 to 8.7 LPH)

Cx1				Drive End		Price				
Control										
C11	Dual Manual Control					\$ 1,236				
C71	Pulse Input w/ Dual Manual Control					\$ 1,337				
C91	Pulse/Analog Input w/ Dual Manual Control - Advanced Features					\$ 1,688				
C11	Power Code	Voltage	Frequency	Plug						
	1	110/240V	50-60 HZ	110 - 120V US Plug		\$ -				
	2	220/240V	50-60 HZ	220 - 240V US Plug		\$ -				
	3	220/240V	50-60 HZ	220 - 240V DIN Plug		\$ -				
	5	220/240V	50-60 HZ	220 - 240V UK Plug		\$ -				
	6	220/240V	50-60 HZ	220 - 240V Aust/NZ Plug		\$ -				
	C11	Liquid End	Head	Fittings	Balls	Cartridge Valve or Seal Ring	RPM Kit			
		Liquipro™								
		362	PVDF	PVDF	Ceramic	PVDF / Polyprel®	RPM-362/368	\$ 276		
		363	PVDF	PVDF	Ceramic	PVDF / PTFE	RPM-363	\$ 317		
		368	PVC	PVC	Ceramic	PVDF / Polyprel®	RPM-362/368	\$ 233		
		460	Acrylic	PVC	Ceramic	PVDF / Polyprel®	RPM-362/368	\$ 341		
		465	PP	PP	Ceramic	PTFE	RPM-465	\$ 344		
		468	PVC	PVC	Ceramic	PVDF / Polyprel®	RPM-362/368	\$ 335		
		469	Acrylic	PVDF	PTFE	PVDF / Polyprel®	RPM-460F	\$ 354		
		LMI								
		75	PP	PP	316SS	PTFE	SP-75HV	\$ 430		
		76	Acrylic	PP	316SS	FKM	SP-76	\$ 430		
		277	316SS	316SS	316SS	316SS	-	\$ 539		
		AutoPrime™								
		D60	Acrylic	PVC	Ceramic	Polyprel®	RPM-D68	\$ 341		
		D68	PVC	PVC	Ceramic	Polyprel®	RPM-D68	\$ 335		
		C11	1	-362	Valve & Connection Code		Compatible with	Valve	Tubing & Connections Suction / Discharge	
					SI		Liquipro™	4FV	PE 3/8" O.D.	\$ 64
					TI		Liquipro™	3FV	PE 3/8" O.D.	\$ -
					NI		Liquipro™	-	PE 3/8" O.D.	\$ -
					HV		LMI Heads only	-	PE 0.5" O.D. / Vinyl 0.938" O.D.	\$ -
					-		316SS LMI Head only	-	Pipe 1/4" NPT M	\$ -
HI					AutoPrime™	4FV	PE 3/8" O.D.	\$ 127		
AI					AutoPrime™	-	PE 3/8" O.D.	\$ 64		
C11		1	-362	SI						

RPM Kit	Price	Contents
Liquipro™		
RPM-362/368	\$ 145	*O-Rings *Shaft Seal
RPM-363	\$ 170	*Check Valve Cartridges
RPM-465	\$ 155	*Hardware kit
RPM-460F	\$ 155	*Liquifram
LMI		
SP-75HV	\$ 160	*Shaft Seal *Liquifram *Seal Ring Seats *Clamp rings
SP-76	\$ 150	*Balls & springs
AutoPrime™		
RPM-D68	\$ 180	*O Rings *Check Valve Cartridges *Shaft Seal *Injection Valve Cartridge *Liquifram *AutoPrime Cartridge

SERIES C PUMP SELECTION AND PRICING

OUTPUT CODE 2

Size Code 1.8

0.0 - 4.0 GPH (0.0 - 15.1 LPH); 100 psi (6.9 bar) **AutoPrime™** estimated at 0.00 to 3.8 GPH (0.00 to 14.4 LPH)

Cx2							Price	
Drive End								
Control								
C12	Dual Manual Control						\$ 1,236	
C72	Pulse Input w/ Dual Manual Control						\$ 1,337	
C92	Pulse/Analog Input w/ Dual Manual Control - Advanced Features						\$ 1,688	
	Power Code	Voltage	Frequency	Plug				
	1	110/240V	50-60 HZ	110 - 120V US Plug		\$ -		
	2	220/240V	50-60 HZ	220 - 240V US Plug		\$ -		
	3	220/240V	50-60 HZ	220 - 240V DIN Plug		\$ -		
	5	220/240V	50-60 HZ	220 - 240V UK Plug		\$ -		
	6	220/240V	50-60 HZ	220 - 240V Aust/NZ Plug		\$ -		
		Liquid End	Head	Fittings	Balls	Cartridge Valve or Seal Ring	RPM Kit	
		Liquipro™						
		362	PVDF	PVDF	Ceramic	PVDF / Polyprel®	RPM-362/368	\$ 276
		363	PVDF	PVDF	Ceramic	PVDF / PTFE	RPM-363	\$ 317
		368	PVC	PVC	Ceramic	PVDF / Polyprel®	RPM-362/368	\$ 233
		460	Acrylic	PVC	Ceramic	PVDF / Polyprel®	RPM-362/368	\$ 341
		465	PP	PP	Ceramic	PTFE	RPM-465	\$ 344
		468	PVC	PVC	Ceramic	PVDF / Polyprel®	RPM-362/368	\$ 335
		469	Acrylic	PVDF	PTFE	PVDF / Polyprel®	RPM-460F	\$ 354
		LMI						
		75	PP	PP	316SS	PTFE	SP-75HV	\$ 430
		76	Acrylic	PP	316SS	FKM	SP-76	\$ 430
		277	316SS	316SS	316SS	316SS	-	\$ 539
		AutoPrime™						
		D60	Acrylic	PVC	Ceramic	Polyprel®	RPM-D68	\$ 341
		D68	PVC	PVC	Ceramic	Polyprel®	RPM-D68	\$ 335
			Valve & Connection Code	Compatible with	Valve	Tubing & Connections		
			SI	Liquipro™	4FV	PE 3/8" O.D.		\$ 64
			TI	Liquipro™	3FV	PE 3/8" O.D.		\$ -
			NI	Liquipro™	-	PE 3/8" O.D.		\$ -
			HV	LMI Heads only	-	PE 0.5" O.D. / Vinyl 0.938" O.D.		\$ -
			-	316SS LMI Head only	-	Pipe 1/4" NPT M		\$ -
			HI	AutoPrime™	4FV	PE 3/8" O.D.		\$ 127
			AI	AutoPrime™	-	PE 3/8" O.D.		\$ 64
C12	1	-362	SI					

RPM Kit	Price	Contents
Liquipro™		
RPM-362/368	\$ 145	*O-Rings *Shaft Seal
RPM-363	\$ 170	*Check Valve Cartridges
RPM-465	\$ 155	*Hardware kit
RPM-460F	\$ 155	*Liquifram
LMI		
SP-75HV	\$ 160	*Shaft Seal *Liquifram *Seal Ring Seats *Clamp rings
SP-76	\$ 150	*Balls & springs
AutoPrime™		
RPM-D68	\$ 180	*O Rings *Check Valve Cartridges *Shaft Seal *Injection Valve Cartridge *Liquifram *AutoPrime Cartridge



SERIES C PUMP SELECTION AND PRICING

OUTPUT CODE 3

Size Code 3.0

0.0 - 8.0 GPH (0.0 - 30.3 LPH); 60 psi (4.1 bar) **AutoPrime™** estimated at 0.00 to 7.8 GPH (0.00 to 29.5 LPH)

Cx3							
Drive End							Price
Control							
C13 Dual Manual Control							\$ 1,236
C73 Pulse Input w/ Dual Manual Control							\$ 1,337
C93 Pulse/Analog Input w/ Dual Manual Control - Advanced Features							\$ 1,688
Power Code	Voltage	Frequency	Plug				
1	110/240V	50-60 HZ	110 - 120V US Plug		\$ -		
2	220/240V	50-60 HZ	220 - 240V US Plug		\$ -		
3	220/240V	50-60 HZ	220 - 240V DIN Plug		\$ -		
5	220/240V	50-60 HZ	220 - 240V UK Plug		\$ -		
6	220/240V	50-60 HZ	220 - 240V Aust/NZ Plug		\$ -		
Liquid End	Head	Fittings	Balls	Cartridge Valve or Seal Ring	Tubing & Connections Suction / Discharge	RPM Kit	
Liquipro™							
312	PVDF	PVDF	Ceramic	PVDF / Polyprel®	see below	RPM-312/318	\$ 386
313	PVDF	PVDF	Ceramic	PVDF / PTFE	see below	RPM-313	\$ 427
318	PVC	PVC	Ceramic	PVDF / Polyprel®	see below	RPM-312/318	\$ 343
410	Acrylic	PVC	Ceramic	PVDF / Polyprel®	see below	RPM-312/318	\$ 451
415	PP	PP	Ceramic	PTFE	see below	RPM-415	\$ 454
418	PVC	PVC	Ceramic	PVDF / Polyprel®	see below	RPM-312/318	\$ 445
419	Acrylic	PVDF	PTFE	PVDF / Polyprel®	see below	RPM-410F	\$ 464
LMI							
20	Acrylic	PVC	Ceramic	FKM	PE 0.5" O.D.	SP-20	\$ 470
20HV	Acrylic	PP	316SS	FKM	PE 0.5" O.D./Vinyl 0.938" O.D.	SP-20HV	\$ 564
20S *	Acrylic	PVC	Ceramic	FKM	PE 0.5" O.D./Vinyl 0.5" O.D.	SP-20	\$ 586
24	PVC	PVC	Ceramic	PTFE	Pipe 0.5" NPT M	SP-U5	\$ 510
25HV	PP	316SS	316SS	PTFE	PE 0.5" O.D./Vinyl 0.938" O.D.	SP-25HV	\$ 564
26	PVC	PVC	Ceramic	FKM	PE 0.5" O.D.	SP-26	\$ 464
26S *	PVC	PVC	Ceramic	FKM	PE 0.5" O.D.	SP-26	\$ 581
27	316SS	316SS	316SS	PTFE	Pipe 0.5" NPT M	SP-27	\$ 1,508
AutoPrime™							
D10	Acrylic	PVC	Ceramic	Polyprel®	see below	RPM-D18	\$ 451
D18	PVC	PVC	Ceramic	Polyprel®	see below	RPM-D18	\$ 445
	Valve & Connection Code		Compatible with		Valve	Tubing & Connections	
	SI		Liquipro™		4FV	PE 0.5" O.D.	
	TI		Liquipro™		3FV	PE 0.5" O.D.	
	NI		Liquipro™		-	PE 0.5" O.D.	
	-		LMI Heads only		-	see above	
	HI		AutoPrime™		4FV	PE 3/8" O.D.	
	AI		AutoPrime™		-	PE 3/8" O.D.	
C13	1	- 312	SI				

RPM Kit	Price	Contents
LMI		
SP-20	\$ 140	
SP-20HV	\$ 180	*Shaft Seal
SP-U5	\$ 210	*Liquifram
SP-25HV	\$ 180	*Seal Ring Seats
SP-26	\$ 220	*Clamp rings
SP-27	\$ 170	*Balls & spring or springs

RPM Kit	Price	Contents
Liquipro™		
RPM-312/318	\$ 150	*O-Rings
RPM-313	\$ 180	*Shaft Seal
RPM-415	\$ 165	*Check Valve Cartridges
RPM-410F	\$ 165	*Hardware kit
		*Liquifram
AutoPrime™		
RPM-D18	\$ 190	*O Rings
		*Check Valve
		*Shaft Seal
		*Injection Valve
		*Liquifram
		*AutoPrime Cartridge

***NOTE:** These liquid ends include a 4 Function Valve
Liquipro Liquid Ends use 3/8" diameter valve balls. Pump output may be reduced in some applications.

SERIES C PUMP SELECTION AND PRICING

OUTPUT CODE 4

Size Code 6.0

0.0 - 20 GPH (0.0 - 75.7 LPH); 25 psi (1.7 bar)

Cx4								
Drive End							Price	
Control								
C14 Dual Manual Control							\$ 1,379	
C74 Pulse Input w/ Dual Manual Control							\$ 1,480	
C94 Pulse/Analog Input w/ Dual Manual Control - Advanced Features							\$ 1,831	
Power Code	Voltage	Frequency	Plug					
1	110/240V	50-60 HZ	110 - 120V US Plug					\$ -
2	220/240V	50-60 HZ	220 - 240V US Plug					\$ -
3	220/240V	50-60 HZ	220 - 240V DIN Plug					\$ -
5	220/240V	50-60 HZ	220 - 240V UK Plug					\$ -
6	220/240V	50-60 HZ	220 - 240V Aust/NZ Plug					\$ -
Liquid End	Head	Fittings	Balls	Seal Ring	Tubing & Connections Suction / Discharge		RPM Kit	
LMI								
30	Acrylic	PVC	Ceramic	PTFE	PE 0.5" O.D. / Vinyl 0.5" O.D.		SP-U6	\$ 597
34	PVC	PVC	Ceramic	PTFE	Pipe 0.5" NPT M		SP-U6	\$ 636
35P	PP	PP	Ceramic	PTFE	Pipe 0.5" NPT M		SP-U6	\$ 669
35T	PP	PP	Ceramic	PTFE	PE .5" O.D.		SP-U6	\$ 623
36	PVC	PVC	Ceramic	PTFE	PE .5" O.D.		SP-U6	\$ 592
37	316SS	316SS	316SS	PTFE	Pipe 0.5" NPT M		SP-37	\$ 1,672
C14	1	- 30						

RPM Kit	Price	Contents
LMI		
SP-U6	\$ 250	*Shaft Seal *Liquifram
SP-37	\$ 190	*Seal Ring Seats *Clamp rings *Balls & spring or springs

SERIES C PUMP SELECTION AND PRICING

OUTPUT CODE 6

Size Code 1.8

0.0 - 4 GPH (0.0 - 15.1 LPH); 175 psi (12.1 bar)

C76										
Drive End									Price	
Control										
C76 Pulse Input w/ Dual Manual Control									\$ 1,551	
Power Code	Voltage		Frequency		Plug					
1	110/240V		50-60 HZ		110 - 120V US Plug					\$ -
2	220/240V		50-60 HZ		220 - 240V US Plug					\$ -
3	220/240V		50-60 HZ		220 - 240V DIN Plug					\$ -
5	220/240V		50-60 HZ		220 - 240V UK Plug					\$ -
6	220/240V		50-60 HZ		220 - 240V Aust/NZ Plug					\$ -
Liquid End	Valve	Head	Fittings	Balls	Cartridge or Seal Ring	Tubing & Connections		RPM Kit		
Liquipro™										
468SP	4FV	PVC	PVC	Ceramic	PVDF/Polyprel®	0.5" NPT M		RPM-362/368		\$ 399
468TP	3FV	PVC	PVC	Ceramic	PVDF/Polyprel®	0.5" NPT M		RPM-362/368		\$ 335
LMI										
277	-	316SS	316SS	316SS	PTFE	1/4" NPT M		-		\$ 539
C76	1	-468SP								

RPM Kit	Price	Contents
Liquipro™		
RPM-362/368	\$ 145	*O-Rings *Shaft Seal *Check Valve Cartridges *Hardware kit *Liquifram

SERIES C PUMP SELECTION AND PRICING

OUTPUT CODE 7

Size Code 3.0

0.0 - 10 GPH (0.0 - 38 LPH); 80 psi (5.5 bar)

C77										
Drive End									Price	
Control										
C77 Pulse Input w/ Dual Manual Control									\$ 1,551	
Power Code	Voltage			Frequency		Plug				
1	110/240V			50-60 HZ		110 - 120V US Plug				\$ -
2	220/240V			50-60 HZ		220 - 240V US Plug				\$ -
3	220/240V			50-60 HZ		220 - 240V DIN Plug				\$ -
5	220/240V			50-60 HZ		220 - 240V UK Plug				\$ -
6	220/240V			50-60 HZ		220 - 240V Aust/NZ Plug				\$ -
Liquid End	Valve	Head	Fittings	Balls	Seal Ring	Tubing & Connections Suction / Discharge		RPM Kit		
LMI										
20	-	Acrylic	PVC	Ceramic	FKM	PE 0.5" O.D. / Vinyl 0.5" O.D.		SP-20		\$ 470
20HV	-	Acrylic	PP	316SS	FKM	PE 0.5" O.D. / Vinyl 0.938" O.D.		SP-20HV		\$ 564
20S	4FV	Acrylic	PVC	Ceramic	FKM	PE 0.5" O.D. / Vinyl 0.5" O.D.		SP-20		\$ 586
24	-	PVC	PVC	Ceramic	PTFE	Pipe 0.5" NPT M		SP-U5		\$ 510
25HV	-	PP	316SS	316SS	PTFE	PE 0.5" O.D. / Vinyl 0.938" O.D.		SP-25HV		\$ 564
25P	-	PP	PP	Ceramic	PTFE	Pipe 0.5" NPT M		SP-U5		\$ 540
25T	-	PP	PP	Ceramic	PTFE	PE 0.5" O.D.		SP-U5		\$ 430
26	-	PVC	PVC	Ceramic	FKM	PE 0.5" O.D.		SP-26		\$ 464
26S	4FV	PVC	PVC	Ceramic	FKM	PE 0.5" O.D.		SP-26		\$ 581
27	-	316SS	316SS	316SS	PTFE	Pipe 0.5" NPT M		SP-27		\$ 1,508
29	-	UHMW PE	UHMW PE	Ceramic	FKM	PE 0.5" O.D.		SP-29		\$ 472
C77	1	-20								

RPM Kit	Price	Contents
LMI		
SP-20	\$ 140	
SP-20HV	\$ 180	*Shaft Seal
SP-U5	\$ 210	*Seal Ring Seats
SP-25HV	\$ 180	*Liquifram
SP-U5	\$ 210	*Clamp rings
SP-26	\$ 220	*Balls & springs
SP-27	\$ 170	
SP-29	\$ 180	

SERIES C PUMP SELECTION AND PRICING

OUTPUT CODE 8

Size Code 6.0

0.0 - 25 GPH (0.0 - 95 LPH); 30 psi (2.7 bar)

C78										
Drive End									Price	
Control										
C78 Pulse Input w/ Dual Manual Control									\$ 1,697	
Power Code	Voltage		Frequency		Plug					
1	110/240V		50-60 HZ		110 - 120V US Plug					\$ -
2	220/240V		50-60 HZ		220 - 240V US Plug					\$ -
3	220/240V		50-60 HZ		220 - 240V DIN Plug					\$ -
5	220/240V		50-60 HZ		220 - 240V UK Plug					\$ -
6	220/240V		50-60 HZ		220 - 240V Aust/NZ Plug					\$ -
Liquid End	Valve	Head	Fittings	Balls	Seal Ring	Tubing & Connections	RPM Kit			
LMI										
30		Acrylic	PVC	Ceramic	PTFE	PE 0.5" O.D	SP-U6			\$ 597
34		PVC	PVC	Ceramic	PTFE	Pipe 0.5" NPT M	SP-U6			\$ 636
35P		PP	PP	Ceramic	PTFE	Pipe 0.5" NPT M	SP-U6			\$ 669
35T		PP	PP	Ceramic	PTFE	PE 0.5" O.D	SP-U6			\$ 623
36		PVC	PVC	Ceramic	PTFE	PE 0.5" O.D	SP-U6			\$ 592
37		316SS	316SS	316SS	PTFE	Pipe 0.5" NPT M	SP-37			\$ 1,672
C78	1	-30								

RPM Kit	Price	Contents
LMI		*Shaft Seal
SP-U6	\$ 250	*Liquifram
SP-37	\$ 190	*Seal Ring Seats
		*Clamp rings
		*Balls & springs

SERIES E METERING PUMPS

Explosion Proof Pumps



For support:



Output Code	Max Output GPH	Max Output LPH	Max Pressure PSI	Max Pressure Bar
Series E with Liquipro™				
0	1.3	4.9	300	20.7
1	2.5	9.5	150	10.3
2	4.0	15.1	100	6.9
3	8.0	30.3	60	4.1
4	20.0	76.0	25	1.7
Series E with AutoPrime™				
1	2.3	8.7	150	10.3
2	3.8	14.4	100	6.9
3	7.8	29.5	60	4.1

Control Code

Key Features	E7
Stroke length manually adjustable	✓
Stroke frequency manually adjustable	✓
External control via pulse input	✓
Manual/External mode selection	✓



4 Function Valve

- This diaphragm type, anti-syphon/pressure relief valve is installed on the pump head.
- Can be oriented as required (360°) at precisely the desired position.
- Easier to use thanks to the more user-friendly design of the priming knobs and back pressure valve

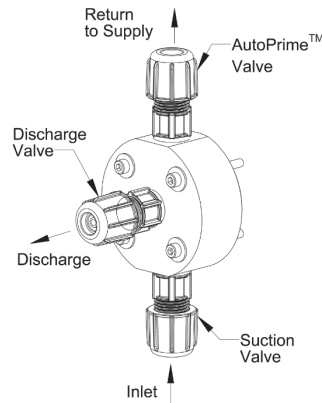

AutoPrime™

Allows for the constant removal of vapors and gases present in applications like sodium hypochlorite and hydrogen peroxide.

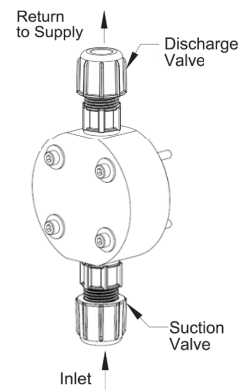

Liquipro™

Standard Liquid End suitable for most applications

What's in the Box

Series E units include:



Tube Connection Hardware



Quick Start Guide

Stainless Steel LE units



Suction/Discharge Tubing



Injection Check Valve



Foot Valve



Ceramic Weight

SERIES E PUMP SELECTION AND PRICING

OUTPUT CODE 0

Size Code 0.9

0.0 - 1.3 GPH (0.0 - 4.9 LPH); 300 psi (20.7 bar)

E70										
Drive End									Price	
Control										
E70 Pulse Input with Dual Manual Control									\$ 3,159	
Power Code	Voltage			Frequency						
1	110/240V			50-60 HZ						\$ -
2	220/240V			50-60 HZ						\$ -
	Liquid End	Valve	Head	Fittings	Balls	Seal Ring	Tubing & Connections	RPM Kit		
Liquipro™										
	498SP	4FV	PVDF	PVDF	Ceramic	PVDF/Polyprel®	Pipe 1/2" NPT M	RPM-392/398	\$ 399	
	498TP	3FV	PVDF	PVDF	Ceramic	PVDF/Polyprel®	Pipe 1/2" NPT M	RPM-392/398	\$ 335	
LMI										
	297	-	316 SS	316 SS	316SS	316SS	Pipe 1/4" NPT M	-	\$ 539	
E70	1	-498SP								

RPM Kit	Price	Contents
Liquipro™		
RPM-392/398	\$ 140	<ul style="list-style-type: none"> *O-Rings *Shaft Seal *Check Valve Cartridges *Hardware kit *Liquifram *Injection Valve Cartridge

Series E Pumps are shipped without power cords and are designed to be hardwired only according to governing codes.

Pumps are rated for: Class I, Division I, Groups C & D; Class II, Division I, Groups E, F, and G

SERIES E PUMP SELECTION AND PRICING

OUTPUT CODE 1

Size Code 1.8

0.0 - 2.5 GPH (0.0 - 9.5 LPH); 150 psi (10.3 bar) **AutoPrime™** estimated at 0.00 to 2.3 GPH (0.00 to 8.7 LPH)

E71							Price
Drive End							
Control							
E71 Pulse Input with Dual Manual Control							\$ 3,159
Power Code	Voltage	Frequency					
1	110/240V	50-60 HZ					\$ -
2	110/240V	50-60 HZ					\$ -
Liquid End	Head	Fittings	Balls	Cartridge Valve or Seal Rings	RPM Kit		
Liquipro™							
362	PVDF	PVDF	Ceramic	PVDF / Polyprel®	RPM-362/368		\$ 276
363	PVDF	PVDF	Ceramic	PVDF / PTFE	RPM-363		\$ 317
368	PVC	PVC	Ceramic	PVDF/ Polyprel®	RPM-362/368		\$ 233
460	Acrylic	PVC	Ceramic	PVDF/ Polyprel®	RPM-362/368		\$ 341
465	PP	PP	Ceramic	PTFE	RPM-465		\$ 344
468	PVC	PVC	Ceramic	PVDF/ Polyprel®	RPM-362/368		\$ 335
469	Acrylic	PVDF	PTFE	PVDF/ Polyprel®	RPM-460F		\$ 354
LMI							
75	PP	PP	316 SS	PTFE	SP-75HV		\$ 430
76	Acrylic	PP	316 SS	FKM	SP-76		\$ 430
277	316 SS	316 SS	316 SS	316 SS	-		\$ 539
AutoPrime™							
D60	Acrylic	PVC	Ceramic	Polyprel®	RPM-D68		\$ 341
D68	PVC	PVC	Ceramic	Polyprel®	RPM-D68		\$ 335
Valve & Connection Code		Compatible with		Valve	Tubing & Connections Suction / Discharge		
SI		Liquipro™		4FV	PE .375" O.D.		\$ 64
TI		Liquipro™		3FV	PE .375" O.D.		\$ -
NI		Liquipro™		-	PE .375" O.D.		\$ -
HI		AutoPrime™		4FV	PE .375" O.D.		\$ 127
AI		AutoPrime™		-	PE .375" O.D.		\$ 64
HV		LMI Heads only		-	PE .5" O.D. / Vinyl .5" O.D.		\$ -
-		316SS LMI Head only		-	Pipe 1/4" NPT M		\$ -
E71	1	-362	SI				

RPM Kit	Price	Contents
Liquipro™		
RPM-362/368	\$ 145	*O-Rings *Shaft Seal
RPM-363	\$ 170	*Check Valve Cartridges
RPM-465	\$ 155	*Hardware kit
RPM-460F	\$ 155	*Liquifram *Injection Valve Cartridge
LMI		
SP-75HV	\$ 160	*Shaft Seal *Liquifram *Seal Ring Seat *Clamp rings
SP-76	\$ 150	*Balls & spring or springs
AutoPrime™		
RPM-D68	\$ 180	*O Rings *Check Valve Cartridges *Shaft Seal *Injection Valve Cartridge *Liquifram *AutoPrime Cartridge

Series E Pumps are shipped without power cords and are designed to be hardwired only according to governing codes.

Pumps are rated for: Class I, Division I, Groups C & D; Class II, Division I, Groups E, F, and G

SERIES E PUMP SELECTION AND PRICING

OUTPUT CODE 2

Size Code 1.8

0.0 - 4.0 GPH (0.0 - 15.1 LPH); 100 psi (6.9 bar) **AutoPrime™** estimated at 0.00 to 3.8 GPH (0.00 to 14.4 LPH)

E72							Drive End	Price
Control								
E72 Pulse Input with Dual Manual Control							\$	3,159
Power Code		Voltage		Frequency				
1		110/240V		50-60 HZ				
2		110/240V		50-60 HZ				
Liquid End		Head	Fittings	Balls	Cartridge Valve or Seal Rings		RPM Kit	
Liquipro™								
362		PVDF	PVDF	Ceramic	PVDF / Polyprel®		RPM-362/368 \$ 276	
363		PVDF	PVDF	Ceramic	PVDF / PTFE		RPM-363 \$ 317	
368		PVC	PVC	Ceramic	PVDF/ Polyprel®		RPM-362/368 \$ 233	
460		Acrylic	PVC	Ceramic	PVDF/ Polyprel®		RPM-362/368 \$ 341	
465		PP	PP	Ceramic	PTFE		RPM-465 \$ 344	
468		PVC	PVC	Ceramic	PVDF/ Polyprel®		RPM-362/368 \$ 335	
469		Acrylic	PVDF	PTFE	PVDF/ Polyprel®		RPM-460F \$ 354	
LMI								
75		PP	PP	316 SS	PTFE		SP-75HV \$ 430	
76		Acrylic	PP	316 SS	FKM		SP-76 \$ 430	
277		316 SS	316 SS	316 SS	316 SS		- \$ 539	
AutoPrime™								
D60		Acrylic	PVC	Ceramic	Polyprel®		RPM-D68 \$ 341	
D68		PVC	PVC	Ceramic	Polyprel®		RPM-D68 \$ 335	
Valve & Connection Code		Compatible with		Valve	Tubing & Connections Suction / Discharge			
SI		Liquipro™		4FV	PE .375" O.D.			\$ 64
TI		Liquipro™		3FV	PE .375" O.D.			\$ -
NI		Liquipro™		-	PE .375" O.D.			\$ -
HI		AutoPrime™		4FV	PE .375" O.D.			\$ 127
AI		AutoPrime™		-	PE .375" O.D.			\$ 64
HV		LMI Heads only		-	PE .5" O.D. / Vinyl .5" O.D.			\$ -
-		316SS LMI Head only		-	Pipe 1/4" NPT M			\$ -
E72	1	-362	SI					

RPM Kit	Price	Contents
Liquipro™		
RPM-362/368	\$ 145	*O-Rings *Shaft Seal
RPM-363	\$ 170	*Check Valve Cartridges
RPM-465	\$ 155	*Hardware kit
RPM-460F	\$ 155	*Liquifram *Injection Valve Cartridge
LMI		
SP-75HV	\$ 160	*Shaft Seal *Liquifram *Seal Ring Seat *Clamp rings
SP-76	\$ 150	*Balls & spring or springs
AutoPrime™		
RPM-D68	\$ 180	*O Rings *Check Valve Cartridges *Shaft Seal *Injection Valve Cartridge *Liquifram *AutoPrime Cartridge

Series E Pumps are shipped without power cords and are designed to be hardwired only according to governing codes.

Pumps are rated for: Class I, Division I, Groups C & D; Class II, Division I, Groups E, F, and G

SERIES E PUMP SELECTION AND PRICING

OUTPUT CODE 3

Size Code 3.0

0.0 - 8.0 GPH (0.0 - 30.3 LPH); 60 psi (4.1 bar) **AutoPrime™** estimated at 0.00 to 7.8 GPH (0.00 to 29.5 LPH)

E73							Price
Drive End							Price
Control							Price
E73 Pulse Input with Dual Manual Control							\$ 3,159
Power Code	Voltage	Frequency					
1	110/240V	50-60 HZ					
2	110/240V	50-60 HZ					
Liquid End	Head	Fittings	Balls	Cartridge Valve or Seal Ring	RPM Kit		
Liquipro™							
These liquid ends use 3/8 diameter valve balls. Pump output may be reduced in some applications.							
312	PVDF	PVDF	Ceramic	PVDF / Polyprel®	RPM-312/318	\$	386
313	PVDF	PVDF	Ceramic	PVDF / PTFE	RPM-313	\$	427
318	PVC	PVC	Ceramic	PVDF/ Polyprel®	RPM-312/318	\$	343
410	Acrylic	PVC	Ceramic	PVDF/ Polyprel®	RPM-312/318	\$	451
415	PP	PP	Ceramic	PTFE	RPM-415	\$	454
418	PVC	PVC	Ceramic	PVDF/ Polyprel®	RPM-312/318	\$	445
419	Acrylic	PVDF	PTFE	PVDF/ Polyprel®	RPM-410F	\$	464
LMI	Valve						
20	-	Acrylic	PVC	Ceramic	FKM	SP-20	\$ 470
20HV	-	Acrylic	PP	316 SS	FKM	SP-20HV	\$ 564
20S	4FV	Acrylic	PVC	Ceramic	FKM	SP-20	\$ 586
24	-	PVC	PVC	Ceramic	PTFE	SP-U5	\$ 510
25HV	-	PP	316SS	316 SS	PTFE	SP-25HV	\$ 564
26	-	PVC	PVC	Ceramic	FKM	SP-26	\$ 464
26S	4FV	PVC	PVC	Ceramic	FKM	SP-26	\$ 581
27	-	316 SS	316 SS	316 SS	PTFE	SP-27	\$ 1,508
AutoPrime™							
D10	Acrylic	PVC	Ceramic	Polyprel®	RPM-D18	\$	451
D18	PVC	PVC	Ceramic	Polyprel®	RPM-D18	\$	445
Valve & Connection Code	Compatible with		Valve	Tubing & Connections			
				Suction / Discharge			
SI	Liquipro™		4FV	PE .375" O.D.		\$	64
TI	Liquipro™		3FV	PE .375" O.D.		\$	-
NI	Liquipro™		-	PE .375" O.D.		\$	-
HI	AutoPrime™		4FV	PE .375" O.D.		\$	127
AI	AutoPrime™		-	PE .375" O.D.		\$	64
HV	LMI Heads only		-	PE .5" O.D. / Vinyl .5" O.D.		\$	-
-	316SS LMI Head only		-	Pipe 1/4" NPT M		\$	-
E73	1	-312	SI				

RPM Kit	Price	Contents
Liquipro™		
RPM-312/318	\$ 150	*O-Rings
		*Shaft Seal
RPM-313	\$ 180	*Check Valve Cartridges
RPM-415	\$ 165	*Hardware kit
RPM-410F	\$ 165	*Liquifram
		*Injection Valve Cartridge
LMI		
SP-20	\$ 140	
SP-20HV	\$ 180	*Shaft Seal
		*Liquifram
SP-20	\$ 140	*Seal Ring Seat
SP-U5	\$ 210	*Clamp rings
SP-25HV	\$ 180	*Balls & spring or springs
SP-26	\$ 220	
SP-27	\$ 170	

RPM Kit	Price	Contents
AutoPrime™		
RPM-D18	\$ 190	*O Rings
		*Shaft Seal
		*Liquifram
		*Check Valve Cartridges
		*Injection Valve Cartridge
		*AutoPrime Cartridge

Series E Pumps are shipped without power cords and are designed to be hardwired only according to governing codes.

Pumps are rated for: Class I, Division I, Groups C & D; Class II, Division I, Groups E, F, and G

SERIES E PUMP SELECTION AND PRICING

OUTPUT CODE 4

Size Code 6.0

0.0 - 20 GPH (0.0 - 75.7 LPH); 25 psi (1.7 bar)

E74								Price		
Drive End										
Control										
E74 Pulse Input with Dual Manual Control								\$	3,304	
Power Code		Voltage		Frequency						
1		110/240V		50-60 HZ				\$	-	
2		110/240V		50-60 HZ				\$	-	
Liquid End		Head	Fittings	Balls	Seal Ring	Tubing & Connections Suction / Discharge		RPM Kit		
LMI										
30		Acrylic	PVC	Ceramic	PTFE	PE 0.5" O.D. / Vinyl 0.5" O.D.		SP-U6	\$ 597	
34		PVC	PVC	Ceramic	PTFE	Pipe 1/2" NPT M		SP-U6	\$ 636	
35P		PP	PP	Ceramic	PTFE	Pipe 1/2" NPT M		SP-U6	\$ 669	
35T		PP	PP	Ceramic	PTFE	PE .5" O.D.		SP-U6	\$ 623	
36		PVC	PVC	Ceramic	PTFE	PE .5" O.D.		SP-U6	\$ 592	
37		316 SS	316 SS	316 SS	PTFE	Pipe 1/2" NPT M		SP-37	\$ 1,672	
E74	1	-30								

RPM Kit	Price	Contents
LMI		
SP-U6	\$ 250	*Shaft Seal
SP-37	\$ 190	*Liquifram
		*Seal Ring Seat
		*Clamp rings
		*Balls & spring or springs

Series E Pumps are shipped without power cords and are designed to be hardwired only according to governing codes.

Pumps are rated for: Class I, Division I, Groups C & D; Class II, Division I, Groups E, F, and G

ROYTRONIC® A METERING PUMPS



Output Code	Max Output GPH	Max Output LPH	Max Pressure PSI	Max Pressure Bar
Roytronic® A with FastPrime™				
1	0.25	1.0	250	17.2
4	0.5	1.9	250	17.2
5	1.0	3.8	110	7.6
6	2.0	7.6	50	3.4
Roytronic® A with AutoPrime™				
1	0.13	0.5	150	17.2
4	0.25	0.9	150	17.2
5	0.65	2.5	110	7.6
6	1.7	6.4	50	3.4

Control Codes

Key Features	A1	A7	A8
Stroke length manually adjustable	✓	✓	✓
Stroke frequency manually adjustable	✓	✓	✓
Pulse signal input controls frequency		✓	
Low level float switch input		✓	✓
4-20 mA signal input controls frequency			✓

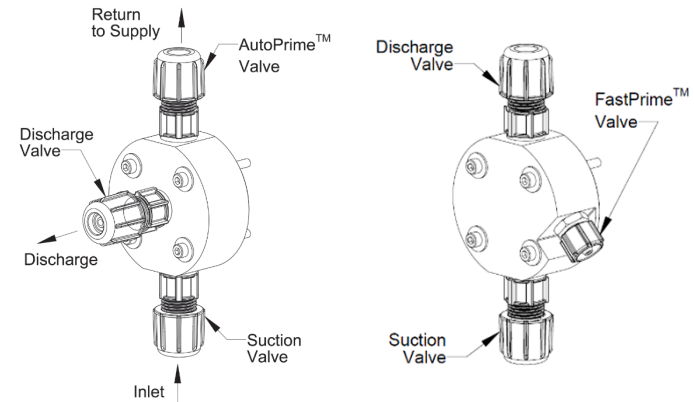

AutoPrime™
Allows for the constant removal of vapors and gases present in applications like sodium hypochlorite and hydrogen peroxide.

FastPrime™
Has an integral manual priming valve to facilitate quick pump start-up.



4 Function Valve

- This diaphragm type, anti-syphon/pressure relief valve is installed on the pump head.
- Can be oriented as required (360°) at precisely the desired position.
- Easier to use thanks to the more user-friendly design of the priming knobs and back pressure valve

What's in the Box

Roytronic A units include:



Tube Connection Hardware



Quick Start Guide



Suction/Discharge Tubing



Injection Check Valve



Foot Valve



Ceramic Weight

Stainless Steel LE units

A7 & A8 units include:



5-pin Control Cable

ROYTRONIC® A PUMP SELECTION AND PRICING

OUTPUT CODE 1

120 SPM Max. Size Code 1

0.003 - 0.25 GPH (0.01 - 1 LPH); 250 psi (17.2 bar)

AutoPrime™ 0.001 to 0.13 GPH (0.005 to 0.5 LPH); 150 psi (10.3 bar)

Ax1								Price
Drive End								
Control								
A11	Dual Manual Control							\$ 497
A71	Pulse Input w/ Dual Manual Control							\$ 589
A81	Analog Input w/ Dual Manual Control							\$ 653
Power Code	Voltage	Frequency	Plug					
1	110/240V	50-60 HZ	110 - 120V US Plug					\$ -
2	220/240V	50-60 HZ	220 - 240V US Plug					\$ -
3	220/240V	50-60 HZ	220 - 240V DIN Plug					\$ -
5	220/240V	50-60 HZ	220 - 240V UK Plug					\$ -
6	220/240V	50-60 HZ	220 - 240V Aust/NZ Plug					\$ -
Liquid End	Head	Fittings	Balls	Seat / O-Ring	Tubing & Connections	RPM Kit		
Machined FastPrime™								
910	Acrylic	PVC	Ceramic	PTFE/Polyprel®	PE 1/4" O.D.	RPM-812	\$ 328	
915	PP	PP	Ceramic	PTFE	PE 1/4" O.D.	RPM-813	\$ 331	
918	PVC	PVC	Ceramic	PTFE/Polyprel®	PE 1/4" O.D.	RPM-812	\$ 322	
919	Acrylic	PVDF	PTFE	Polyprel®	PE 1/4" O.D.	RPM-919	\$ 341	
917*	316SS	316SS	316SS	316SS/PTFE	1/4" NPT	RPM-917	\$ 526	
Molded FastPrime™								
812	PVDF	PVDF	Ceramic	PTFE/Polyprel®	PE 1/4" O.D.	RPM-812	\$ 263	
813	PVDF	PVDF	Ceramic	PTFE	PE 1/4" O.D.	RPM-813	\$ 304	
818	PVC	PVC	Ceramic	PTFE/Polyprel®	PE 1/4" O.D.	RPM-812	\$ 220	
AutoPrime™								
910	Acrylic	PVC	Ceramic	PTFE/Polyprel®	PE 1/4" O.D.	RPM-910A	\$ 328	
918	PVC	PVC	Ceramic	PTFE/Polyprel®	PE 1/4" O.D.	RPM-910A	\$ 322	
Valve Code	Compatible with			Valve				
S	FastPrime™			4 Function Valve			\$ 64	
N	FastPrime™			-			\$ -	
H	AutoPrime™			4 Function Valve			\$ 127	
A	AutoPrime™			-			\$ 64	
Connection Code								
I	Inch Tube connections with tubing - also includes 1/2" NPT and 1/2" BSP connection.							\$ -
P	1/4" NPT (Only available with 316 SS Head & N Valve Code)							\$ -
A11	1	- 910	S	I				

RPM Kit	Price	Contents
Machined FastPrime™		
RPM-812	\$ 135	*O Rings *Shaft Seal *Liquifram
RPM-813	\$ 150	
RPM-919	\$ 135	
RPM-917	\$ 260	
Molded FastPrime™		
RPM-812	\$ 135	*Check Valve Cartridges
RPM-813	\$ 150	*Injection Valve Cartridge
AutoPrime™		
RPM-910A	\$ 155	*FastPrime or AutoPrime Cartridge

AutoPrime™ heads have 3 check valves: Suction on the bottom; Discharge on the front; AutoPrime™ bleed on the top.

By design, a repeatable portion of the process fluid continuously bleeds through the top check valve to be returned to the chemical supply. The result is the assurance that any gas in the head is automatically relieved thus eliminating air-binding.

***NOTE:** 316SS Head only available with N FastPrime code and P Connection Code

ROYTRONIC® A PUMP SELECTION AND PRICING

OUTPUT CODE 4

240 SPM Max. Size Code 1

0.005 - 0.5 GPH (0.02 - 1.9 LPH); 150 psi (10.3 bar)

AutoPrime™ 0.003 to 0.25 GPH (0.01 to 0.9 LPH); 150 psi (10.3 bar)

Ax4								Price
Drive End								
Control								
A14	Dual Manual Control							\$ 497
A74	Pulse Input w/ Dual Manual Control							\$ 589
A84	Analog Input w/ Dual Manual Control							\$ 653
Power Code	Voltage	Frequency	Plug					
1	110/240V	50-60 HZ	110 - 120V US Plug					\$ -
2	220/240V	50-60 HZ	220 - 240V US Plug					\$ -
3	220/240V	50-60 HZ	220 - 240V DIN Plug					\$ -
5	220/240V	50-60 HZ	220 - 240V UK Plug					\$ -
6	220/240V	50-60 HZ	220 - 240V Aust/NZ Plug					\$ -
Liquid End	Head	Fittings	Balls	Seat / O-Ring	Tubing & Connections	RPM Kit		
Machined FastPrime™								
910	Acrylic	PVC	Ceramic	PTFE/Polyprel®	PE 1/4" O.D.	RPM-812	\$ 328	
915	PP	PP	Ceramic	PTFE	PE 1/4" O.D.	RPM-813	\$ 331	
918	PVC	PVC	Ceramic	PTFE/Polyprel®	PE 1/4" O.D.	RPM-812	\$ 322	
919	Acrylic	PVDF	PTFE	Polyprel®	PE 1/4" O.D.	RPM-919	\$ 341	
917*	316SS	316SS	316SS	316SS/PTFE	1/4" NPT	RPM-917	\$ 526	
Molded FastPrime™								
812	PVDF	PVDF	Ceramic	PTFE/Polyprel®	PE 1/4" O.D.	RPM-812	\$ 263	
813	PVDF	PVDF	Ceramic	PTFE	PE 1/4" O.D.	RPM-813	\$ 304	
818	PVC	PVC	Ceramic	PTFE/Polyprel®	PE 1/4" O.D.	RPM-812	\$ 220	
AutoPrime™								
910	Acrylic	PVC	Ceramic	PTFE/Polyprel®	PE 1/4" O.D.	RPM-910A	\$ 328	
918	PVC	PVC	Ceramic	PTFE/Polyprel®	PE 1/4" O.D.	RPM-910A	\$ 322	
Valve Code	Compatible with			Valve				
S	FastPrime™			4 Function Valve			\$ 64	
N	FastPrime™			-			\$ -	
H	AutoPrime™			4 Function Valve			\$ 127	
A	AutoPrime™			-			\$ 64	
Connection Code								
I	Inch Tube connections with tubing - also includes 1/2" NPT and 1/2" BSP connection.						\$ -	
P	1/4" NPT (Only available with 316 SS Head & N Valve Code)						\$ -	
A14	1	- 910	S	I				

RPM Kit	Price	Contents
Machined FastPrime™		
RPM-812	\$ 135	*O Rings *Shaft Seal *Liquifram
RPM-813	\$ 150	
RPM-919	\$ 135	
RPM-917	\$ 260	
Molded FastPrime™		
RPM-812	\$ 135	*Check Valve Cartridges
RPM-813	\$ 150	*Injection Valve Cartridge
AutoPrime™		
RPM-910A	\$ 155	*FastPrime or AutoPrime Cartridge

AutoPrime™ heads have 3 check valves: Suction on the bottom; Discharge on the front; AutoPrime™ bleed on the top.

By design, a repeatable portion of the process fluid continuously bleeds through the top check valve to be returned to the chemical supply. The result is the assurance that any gas in the head is automatically relieved thus eliminating air-binding.

***NOTE:** 316SS Head only available with N FastPrime code and P Connection Code

ROYTRONIC® A PUMP SELECTION AND PRICING

OUTPUT CODE 5

240 SPM Max. Size Code 2

0.01 - 1.0 GPH (0.04 - 3.8 LPH); 110 psi (7.6 bar)

AutoPrime™ 0.006 to 0.65 GPH (0.02 to 2.5 LPH); 110 psi (7.6 bar)

Ax5								Price
Drive End								
Control								
A15	Dual Manual Control							\$ 497
A75	Pulse Input w/ Dual Manual Control							\$ 589
A85	Analog Input w/ Dual Manual Control							\$ 653
Power Code	Voltage	Frequency	Plug					
1	110/240V	50-60 HZ	110 - 120V US Plug					\$ -
2	220/240V	50-60 HZ	220 - 240V US Plug					\$ -
3	220/240V	50-60 HZ	220 - 240V DIN Plug					\$ -
5	220/240V	50-60 HZ	220 - 240V UK Plug					\$ -
6	220/240V	50-60 HZ	220 - 240V Aust/NZ Plug					\$ -
Liquid End	Head	Fittings	Balls	Seat / O-Ring	Tubing & Connections		RPM Kit	
Machined FastPrime™								
920	Acrylic	PVC	Ceramic	PTFE/Polyprel®	PE 3/8" O.D.		RPM-822	\$ 340
925	PP	PP	Ceramic	PTFE	PE 3/8" O.D.		RPM-823	\$ 343
928	PVC	PVC	Ceramic	PTFE/Polyprel®	PE 3/8" O.D.		RPM-822	\$ 334
929	Acrylic	PVDF	PTFE	Polyprel®	PE 3/8" O.D.		RPM-929	\$ 353
927*	316SS	316SS	316SS	316SS/PTFE	1/4" NPT		RPM-927	\$ 538
Molded FastPrime™								
822	PVDF	PVDF	Ceramic	PTFE/Polyprel®	PE 3/8" O.D.		RPM-822	\$ 275
823	PVDF	PVDF	Ceramic	PTFE	PE 3/8" O.D.		RPM-823	\$ 316
828	PVC	PVC	Ceramic	PTFE/Polyprel®	PE 3/8" O.D.		RPM-822	\$ 232
AutoPrime™								
920	Acrylic	PVC	Ceramic	PTFE/Polyprel®	PE 3/8" O.D.		RPM-920A	\$ 340
928	PVC	PVC	Ceramic	PTFE/Polyprel®	PE 3/8" O.D.		RPM-920A	\$ 334
Valve Code	Compatible with			Valve				
S	FastPrime™			4 Function Valve			\$ 64	
N	FastPrime™			-			\$ -	
H	AutoPrime™			4 Function Valve			\$ 127	
A	AutoPrime™			-			\$ 64	
Connection Code								
I	Inch Tube connections with tubing - also includes 1/2" NPT and 1/2" BSP connection.							\$ -
P	1/4" NPT (Only available with 316 SS Head & N Valve Code)							\$ -
A15	1	- 920	S	I				

RPM Kit	Price	Contents
Machined FastPrime™		
RPM-822	\$ 140	*O Rings *Shaft Seal *Liquifram
RPM-823	\$ 160	
RPM-929	\$ 140	
RPM-927	\$ 270	
Molded FastPrime™		
RPM-822	\$ 140	*Check Valve Cartridges
RPM-823	\$ 160	*Injection Valve Cartridge
		*FastPrime or AutoPrime Cartridge
AutoPrime™		
RPM-920A	\$ 160	

AutoPrime™ heads have 3 check valves: Suction on the bottom; Discharge on the front; AutoPrime™ bleed on the top.

By design, a repeatable portion of the process fluid continuously bleeds through the top check valve to be returned to the chemical supply. The result is the assurance that any gas in the head is automatically relieved thus eliminating air-binding.

***NOTE:** 316SS Head only available with N FastPrime code and P Connection Code

ROYTRONIC® A PUMP SELECTION AND PRICING

OUTPUT CODE 6

240 SPM Max. Size Code 3

0.02 - 2.0 GPH (0.08 - 7.6 LPH); 50 psi (3.4 bar)

AutoPrime™ 0.017 to 1.7 GPH (0.06 to 6.4 LPH); 50 psi (3.4 bar)

Ax6								
Drive End							Price	
Control								
A16	Dual Manual Control						\$	533
A76	Pulse Input w/ Dual Manual Control						\$	625
A86	Analog Input w/ Dual Manual Control						\$	689
Power Code	Voltage	Frequency	Plug					
1	110/240V	50-60 HZ	110 - 120V US Plug					\$ -
2	220/240V	50-60 HZ	220 - 240V US Plug					\$ -
3	220/240V	50-60 HZ	220 - 240V DIN Plug					\$ -
5	220/240V	50-60 HZ	220 - 240V UK Plug					\$ -
6	220/240V	50-60 HZ	220 - 240V Aust/NZ Plug					\$ -
Liquid End	Head	Fittings	Balls	Seat / O-Ring	Tubing & Connections	RPM Kit		
Machined FastPrime™								
930	Acrylic	PVC	Ceramic	Polyprel®	PE 3/8" O.D.	RPM-832	\$ 340	
935	PP	PP	Ceramic	PTFE	PE 3/8" O.D.	RPM-833	\$ 343	
938	PVC	PVC	Ceramic	Polyprel®	PE 3/8" O.D.	RPM-832	\$ 334	
939	Acrylic	PVDF	PTFE	Polyprel®	PE 3/8" O.D.	RPM-939	\$ 353	
937*	316SS	316SS	316SS	316SS/PTFE	1/4" NPT	RPM-937	\$ 538	
Molded FastPrime™								
832	PVDF	PVDF	Ceramic	Polyprel®	PE 3/8" O.D.	RPM-832	\$ 275	
833	PVDF	PVDF	Ceramic	PTFE	PE 3/8" O.D.	RPM-833	\$ 316	
838	PVC	PVC	Ceramic	Polyprel®	PE 3/8" O.D.	RPM-832	\$ 232	
AutoPrime™								
930	Acrylic	PVC	Ceramic	PTFE/Polyprel®	PE 3/8" O.D.	RPM-930A	\$ 340	
938	PVC	PVC	Ceramic	PTFE/Polyprel®	PE 3/8" O.D.	RPM-930A	\$ 334	
Valve Code	Compatible with			Valve			Price	
S	FastPrime™			4 Function Valve			\$ 64	
N	FastPrime™			-			\$ -	
H	AutoPrime™			4 Function Valve			\$ 127	
A	AutoPrime™			-			\$ 64	
Connection Code								
I	Inch Tube connections with tubing - also includes 1/2" NPT and 1/2" BSP connection.						\$	-
P	1/4" NPT (Only available with 316 SS Head & N Valve Code)						\$	-
A16	1	- 930	S	I				

RPM Kit	Price	Contents
Machined FastPrime™		
RPM-832	\$ 145	*O Rings *Shaft Seal *Liquifram
RPM-833	\$ 170	
RPM-939	\$ 145	
RPM-937	\$ 280	
Molded FastPrime™		
RPM-832	\$ 145	*Check Valve Cartridges *Injection Valve Cartridge *FastPrime or AutoPrime Cartridge
RPM-833	\$ 170	
AutoPrime™		
RPM-930A	\$ 165	

AutoPrime™ heads have 3 check valves: Suction on the bottom; Discharge on the front; AutoPrime™ bleed on the top.

By design, a repeatable portion of the process fluid continuously bleeds through the top check valve to be returned to the chemical supply. The result is the assurance that any gas in the head is automatically relieved thus eliminating air-binding.

***NOTE:** 316SS Head only available with N FastPrime code and P Connection Code

SERIES P METERING PUMPS



For support:



Output Code	Max Output GPH	Max Output LPH	Max Pressure PSI	Max Pressure Bar
Series P with Liquipro™				
2	0.21	0.79	150	10.3
3	0.42	1.6	110	7.6
4	0.58	2.2	250	17.3
5	1.0	3.8	110	7.6
6	2.0	7.6	50	3.4
Series P with AutoPrime™				
2	0.13	0.5	150	10.3
3	0.33	1.3	110	7.6
4	0.42	1.6	250	17.3
5	0.85	3.2	110	7.6
6	1.85	7.0	50	3.4

Control Codes

Key Features	P0	P1	P7
Stroke length manually adjustable	✓	✓	✓
Stroke frequency manually adjustable		✓	✓
Pulse signal input controls frequency			✓
Low level float switch input			✓



4 Function Valve

- This diaphragm type, anti-siphon/pressure relief valve is installed on the pump head.
- Can be oriented as required (360°) at precisely the desired position.
- Easier to use thanks to the more user-friendly design of the priming knobs and back pressure valve

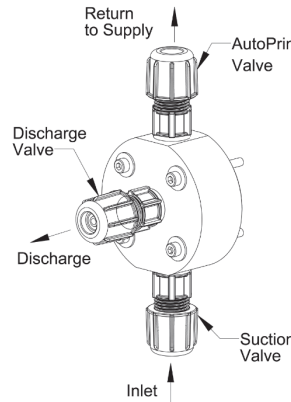

AutoPrime™

Allows for the constant removal of vapors and gases present in applications like sodium hypochlorite and hydrogen peroxide.

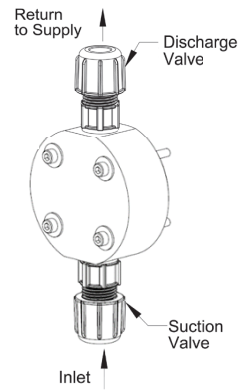

Liquipro™

Standard Liquid End suitable for most applications

What's in the Box

Series P units include:					Certain P7 units include:
	Stainless Steel LE units				

SERIES P PUMP SELECTION AND PRICING

OUTPUT CODE 2

Size Code 0.5

P02: 0.060 - 0.21 GPH (0.24 - 0.79 LPH); 150 psi (10.3 bar)

AutoPrime™ estimated: 0.060 to 0.13 GPH (0.24 to 0.5 LPH)

P12: 0.003 - 0.21 GPH (0.01 - 0.79 LPH); 150 psi (10.3 bar)

AutoPrime™ estimated: 0.003 to 0.13 GPH (0.01 to 0.5 LPH)

Px2								Price
Drive End								
Control								
P02 Single Manual Control								\$ 203
P12 Dual Manual Control								\$ 289
Power Code	Voltage		Frequency		Plug			
1	110/120 VAC		50-60 HZ		110 - 120 VAC US Plug			\$ -
2	220/240 VAC		50-60 HZ		220 - 240 VAC US Plug			\$ -
3	220/240 VAC		50-60 HZ		220 - 240 VAC DIN Plug			\$ -
5	220/240 VAC		50-60 HZ		220 - 240 VAC UK Plug			\$ -
6	220/240 VAC		50-60 HZ		220 - 240V Aust/NZ Plug			\$ -
Liquid End	Head	Fitting	Balls	Seat / O-Ring	Tubing & Connections		RPM Kit	
Liquipro™ Machined								
450	Acrylic	PVC	Ceramic	Polyprel®	PE 1/4" O.D.		RPM-352/358	\$ 328
455	PP	PP	Ceramic	PTFE	PE 1/4" O.D.		RPM-455	\$ 331
458	PVC	PVC	Ceramic	Polyprel®	PE 1/4" O.D.		RPM-352/358	\$ 322
459	Acrylic	PVDF	PTFE	Polyprel®	PE 1/4" O.D.		RPM-450F	\$ 341
257	316SS	316SS	316SS	316SS/PTFE	1/4" NPT M		-	\$ 526
Liquipro™ Molded								
352	PVDF	PVDF	Ceramic	Polyprel®	PE 1/4" O.D.		RPM-352/358	\$ 263
353	PVDF	PVDF	Ceramic	PTFE	PE 1/4" O.D.		RPM-353	\$ 304
358	PVC	PVC	Ceramic	Polyprel®	PE 1/4" O.D.		RPM-352/358	\$ 220
AutoPrime™								
D50	Acrylic	PVC	Ceramic	Polyprel®	PE 1/4" O.D.		RPM-D58	\$ 328
D58	PVC	PVC	Ceramic	Polyprel®	PE 1/4" O.D.		RPM-D58	\$ 322
Valve Code	Compatible with			Valve				
S	Liquipro™			4FV			\$ 64	
T	Liquipro™			3FV			\$ -	
H	AutoPrime™			4FV			\$ 127	
A	AutoPrime™			-			\$ 64	
-	316SS Liquipro™ Head only			-			\$ -	
Connection Code								
I	Inch Tube connections with tubing - also includes 1/2" NPT and 1/2" BSP connection							\$ -
-	1/4" NPT M (Only available with 316SS Liquipro™ Head)							\$ -
P02	1	- 450	S	I				

RPM Kit	Price	Contents
Liquipro™ - Machined		
RPM-352/358	\$ 135	*O-Rings
RPM-455	\$ 135	*Hardware kit
RPM-450F	\$ 135	*Shaft Seal
Liquipro™ - Molded		
RPM-352/358	\$ 135	*Check Valve Cartridges
RPM-353	\$ 150	*Liquifram
		*Injection Valve Cartridge
AutoPrime™		
RPM-D58	\$ 160	*O Rings
		*Shaft Seal
		*Liquifram
		*Check Valve Cartridges
		*Injection Valve Cartridge
		*AutoPrime Cartridge

AUTOPRIME™ heads have 3 check valves: Suction on the bottom; Discharge on the front; AUTOPRIME™ bleed on the top. By design, a repeatable portion of the process fluid continuously bleeds through the top check valve to be returned to the chemical supply. The result is the assurance that any gas in the head is automatically relieved thus eliminating air-binding.

SERIES P PUMP SELECTION AND PRICING

OUTPUT CODE 3

Size Code 0.9

P03: 0.13 - 0.42 GPH (0.48 - 1.6 LPH); 110 psi (7.6 bar)**AutoPrime™** estimated: 0.13 to 0.33 GPH (0.48 to 1.3 LPH)**P13:** 0.01 - 0.42 GPH (0.02 - 1.6 LPH); 110 psi (7.6 bar)**AutoPrime™** estimated: 0.01 to 0.33 GPH (0.02 to 1.3 LPH)

Px3								Price
Drive End								
Control								
P03	Single Manual Control							\$ 203
P13	Dual Manual Control							\$ 289
Power Code	Voltage		Frequency		Plug			
1	110/120 VAC		50-60 HZ		110 - 120 VAC US Plug			\$ -
2	220/240 VAC		50-60 HZ		220 - 240 VAC US Plug			\$ -
3	220/240 VAC		50-60 HZ		220 - 240 VAC DIN Plug			\$ -
5	220/240 VAC		50-60 HZ		220 - 240 VAC UK Plug			\$ -
6	220/240 VAC		50-60 HZ		220 - 240V Aust/NZ Plug			\$ -
Liquid End	Head	Fitting	Balls	Seat / O-Ring	Tubing & Connections	RPM Kit		
Liquipro™ Machined								
490	Acrylic	PVC	Ceramic	Polyprel®	PE 3/8" O.D.	RPM-392/398		\$ 341
495	PP	PP	Ceramic	PTFE	PE 3/8" O.D.	RPM-495		\$ 344
498	PVC	PVC	Ceramic	Polyprel®	PE 3/8" O.D.	RPM-392/398		\$ 335
499	Acrylic	PVDF	PTFE	Polyprel®	PE 3/8" O.D.	RPM-490F		\$ 354
297	316SS	316SS	316SS	316SS/PTFE	1/4" NPT M	-		\$ 539
Liquipro™ Molded								
392	PVDF	PVDF	Ceramic	Polyprel®	PE 3/8" O.D.	RPM-392/398		\$ 276
393	PVDF	PVDF	Ceramic	PTFE	PE 3/8" O.D.	RPM-393		\$ 317
398	PVC	PVC	Ceramic	Polyprel®	PE 3/8" O.D.	RPM-392/398		\$ 233
AutoPrime™								
D90	Acrylic	PVC	Ceramic	Polyprel®	PE 3/8" O.D.	RPM-D98		\$ 341
D98	PVC	PVC	Ceramic	Polyprel®	PE 3/8" O.D.	RPM-D98		\$ 335
Valve Code	Compatible with				Valve			
S	Liquipro™				4FV		\$ 64	
T	Liquipro™				3FV		\$ -	
H	AutoPrime™				4FV		\$ 127	
A	AutoPrime™				-		\$ 64	
-	316SS Liquipro™ Head only				-		\$ -	
Connection Code								
I	Inch Tube connections with tubing - also includes 1/2" NPT and 1/2" BSP connection							\$ -
-	1/4" NPT M (Only available with 316SS Liquipro™ Head)							\$ -
P03	1	- 490	S	I				

RPM Kit	Price	Contents
Liquipro™ - Machined		
RPM-392/398	\$ 140	*O-Rings
RPM-455	\$ 135	*Hardware kit
RPM-450F	\$ 135	*Shaft Seal
Liquipro™ - Molded		
RPM-392/398	\$ 140	*Check Valve Cartridges
RPM-353	\$ 150	*Liquifram
		*Injection Valve Cartridge
AutoPrime™		
RPM-D58	\$ 160	*O Rings
		*Shaft Seal
		*Liquifram
		*Check Valve Cartridges
		*Injection Valve Cartridge
		*AutoPrime Cartridge

AUTOPRIME™ heads have 3 check valves: Suction on the bottom; Discharge on the front; AUTOPRIME™ bleed on the top. By design, a repeatable portion of the process fluid continuously bleeds through the top check valve to be returned to the chemical supply. The result is the assurance that any gas in the head is automatically relieved thus eliminating air-binding.

SERIES P PUMP SELECTION AND PRICING

OUTPUT CODE 4

Size Code 0.5

0.0 - 0.58 GPH (0.0 - 2.2 LPH); 250 psi (17.2 bar)

AutoPrime™ estimated at 0.00 to 0.42 GPH (0.00 to 1.6 LPH); 250 psi (17.2 bar)

Px4								Price
Drive End								Price
Control								
P04	Single Manual Control							\$ 230
P14	Dual Manual Control							\$ 316
P74	Pulse Input w/ Dual Manual Control							\$ 433
Power Code	Voltage		Frequency		Plug			
1	110/120 VAC		50-60 HZ		110 - 120 VAC US Plug			\$ -
2	220/240 VAC		50-60 HZ		220 - 240 VAC US Plug			\$ -
3	220/240 VAC		50-60 HZ		220 - 240 VAC DIN Plug			\$ -
5	220/240 VAC		50-60 HZ		220 - 240 VAC UK Plug			\$ -
6	220/240 VAC		50-60 HZ		220 - 240V Aust/NZ Plug			\$ -
Liquid End	Head	Fitting	Balls	Seat / O-Ring	Tubing & Connections		RPM Kit	
Liquipro™ Machined								
450	Acrylic	PVC	Ceramic	Polyprel®	PE 1/4" O.D.		RPM-352/358	\$ 328
455	PP	PP	Ceramic	PTFE	PE 1/4" O.D.		RPM-455	\$ 331
458	PVC	PVC	Ceramic	Polyprel®	PE 1/4" O.D.		RPM-352/358	\$ 322
459	Acrylic	PVDF	PTFE	Polyprel®	PE 1/4" O.D.		RPM-450F	\$ 341
257	316SS	316SS	316SS	316SS/PTFE	1/4" NPT M		-	\$ 526
Liquipro™ Molded								
352	PVDF	PVDF	Ceramic	Polyprel®	PE 1/4" O.D.		RPM-352/358	\$ 263
353	PVDF	PVDF	Ceramic	PTFE	PE 1/4" O.D.		RPM-353	\$ 304
358	PVC	PVC	Ceramic	Polyprel®	PE 1/4" O.D.		RPM-352/358	\$ 220
AutoPrime™								
D50	Acrylic	PVC	Ceramic	Polyprel®	PE 1/4" O.D.		RPM-D58	\$ 328
D58	PVC	PVC	Ceramic	Polyprel®	PE 1/4" O.D.		RPM-D58	\$ 322
Valve Code	Compatible with				Valve			
S	Liquipro™				4FV		\$ 64	
T	Liquipro™				3FV		\$ -	
H	AutoPrime™				4FV		\$ 127	
A	AutoPrime™				-		\$ 64	
-	316SS Liquipro™ Head only				-		\$ -	
Connection Code								
I	Inch Tube connections with tubing - also includes 1/2" NPT and 1/2" BSP connection							\$ -
-	1/4" NPT M (Only available with 316SS Liquipro™ Head)							\$ -
P04	1	- 450	S	I				

RPM Kit	Price	Contents
Liquipro™ - Machined		
RPM-352/358	\$ 135	*O-Rings
RPM-455	\$ 135	*Hardware kit
RPM-450F	\$ 135	*Shaft Seal
Liquipro™ - Molded		
RPM-352/358	\$ 135	*Check Valve Cartridges
RPM-353	\$ 150	*Liquifram
		*Injection Valve Cartridge
AutoPrime™		
RPM-D58	\$ 160	*O Rings
		*Shaft Seal
		*Liquifram
		*Check Valve Cartridges
		*Injection Valve Cartridge
		*AutoPrime Cartridge

AUTOPRIME™ heads have 3 check valves: Suction on the bottom; Discharge on the front; AUTOPRIME™ bleed on the top. By design, a repeatable portion of the process fluid continuously bleeds through the top check valve to be returned to the chemical supply. The result is the assurance that any gas in the head is automatically relieved thus eliminating air-binding.

SERIES P PUMP SELECTION AND PRICING

OUTPUT CODE 5

Size Code 0.9

0.0 - 1.0 GPH (0.0 - 3.8 LPH); 110 psi (7.6 bar)

AutoPrime™ estimated at 0.00 to 0.85 GPH (0.00 to 3.2 LPH); 110 psi (7.6 bar)

Px5								Price
Drive End								Price
Control								
P05	Single Manual Control							\$ 230
P15	Dual Manual Control							\$ 316
P75	Pulse Input w/ Dual Manual Control							\$ 433
Power Code	Voltage		Frequency		Plug			
1	110/120 VAC		50-60 HZ		110 - 120 VAC US Plug			\$ -
2	220/240 VAC		50-60 HZ		220 - 240 VAC US Plug			\$ -
3	220/240 VAC		50-60 HZ		220 - 240 VAC DIN Plug			\$ -
5	220/240 VAC		50-60 HZ		220 - 240 VAC UK Plug			\$ -
6	220/240 VAC		50-60 HZ		220 - 240V Aust/NZ Plug			\$ -
Liquid End	Head	Fitting	Balls	Seat / O-Ring	Tubing & Connections		RPM Kit	
Liquipro™ Machined								
490	Acrylic	PVC	Ceramic	Polyprel®	PE 3/8" O.D.		RPM-392/398	\$ 341
495	PP	PP	Ceramic	PTFE	PE 3/8" O.D.		RPM-495	\$ 344
498	PVC	PVC	Ceramic	Polyprel®	PE 3/8" O.D.		RPM-392/398	\$ 335
499	Acrylic	PVDF	PTFE	Polyprel®	PE 3/8" O.D.		RPM-490F	\$ 354
297	316SS	316SS	316SS	316SS/PTFE	1/4" NPT M		-	\$ 539
Liquipro™ Molded								
392	PVDF	PVDF	Ceramic	Polyprel®	PE 3/8" O.D.		RPM-392/398	\$ 276
393	PVDF	PVDF	Ceramic	PTFE	PE 3/8" O.D.		RPM-393	\$ 317
398	PVC	PVC	Ceramic	Polyprel®	PE 3/8" O.D.		RPM-392/398	\$ 233
AutoPrime™								
D90	Acrylic	PVC	Ceramic	Polyprel®	PE 3/8" O.D.		RPM-D98	\$ 341
D98	PVC	PVC	Ceramic	Polyprel®	PE 3/8" O.D.		RPM-D98	\$ 335
Valve Code	Compatible with			Valve				
S	Liquipro™			4FV			\$ 64	
T	Liquipro™			3FV			\$ -	
H	AutoPrime™			4FV			\$ 127	
A	AutoPrime™			-			\$ 64	
-	316SS Liquipro™ Head only			-			\$ -	
Connection Code								
I	Inch Tube connections with tubing - also includes 1/2" NPT and 1/2" BSP connection							\$ -
-	1/4" NPT M (Only available with 316SS Liquipro™ Head)							\$ -
P05	1	- 490	S	I				

RPM Kit	Price	Contents
Liquipro™ - Machined		
RPM-392/398	\$ 140	*O-Rings
RPM-495	\$ 145	*Hardware kit
RPM-490F	\$ 145	*Shaft Seal
Liquipro™ - Molded		
RPM-392/398	\$ 140	*Check Valve Cartridges
RPM-393	\$ 160	*Liquifram
		*Injection Valve Cartridge
AutoPrime™		
RPM-D98	\$ 170	*O Rings
		*Shaft Seal
		*Liquifram
		*Check Valve Cartridges
		*Injection Valve Cartridge
		*AutoPrime Cartridge

AUTOPRIME™ heads have 3 check valves: Suction on the bottom; Discharge on the front; AUTOPRIME™ bleed on the top. By design, a repeatable portion of the process fluid continuously bleeds through the top check valve to be returned to the chemical supply. The result is the assurance that any gas in the head is automatically relieved thus eliminating air-binding.

SERIES P PUMP SELECTION AND PRICING

OUTPUT CODE 6

Size Code 1.8

0.0 - 2.0 GPH (0.0 - 7.6 LPH); 50 psi (3.4 bar)

AutoPrime™ estimated at 0.00 to 1.85 GPH (0.00 to 7.0 LPH); 50 psi (3.4 bar)

Px6								Price
Drive End								
Control								
P06	Single Manual Control							\$ 253
P16	Dual Manual Control							\$ 339
P76	Pulse Input w/ Dual Manual Control							\$ 456
Power Code	Voltage		Frequency		Plug			
1	110/120 VAC		50-60 HZ		110 - 120 VAC US Plug			\$ -
2	220/240 VAC		50-60 HZ		220 - 240 VAC US Plug			\$ -
3	220/240 VAC		50-60 HZ		220 - 240 VAC DIN Plug			\$ -
5	220/240 VAC		50-60 HZ		220 - 240 VAC UK Plug			\$ -
6	220/240 VAC		50-60 HZ		220 - 240V Aust/NZ Plug			\$ -
Liquid End	Head	Fitting	Balls	Seat / O-Ring	Tubing & Connections		RPM Kit	
Liquipro™ Machined								
460	Acrylic	PVC	Ceramic	Polyprel®	PE 3/8" O.D.		RPM-362/368	\$ 341
465	PP	PP	Ceramic	PTFE	PE 3/8" O.D.		RPM-465	\$ 344
468	PVC	PVC	Ceramic	Polyprel®	PE 3/8" O.D.		RPM-362/368	\$ 335
469	Acrylic	PVDF	PTFE	Polyprel®	PE 3/8" O.D.		RPM-460F	\$ 354
277	316SS	316SS	316SS	316SS/PTFE	1/4" NPT M		-	\$ 539
Liquipro™ Molded								
362	PVDF	PVDF	Ceramic	Polyprel®	PE 3/8" O.D.		RPM-352/358	\$ 276
363	PVDF	PVDF	Ceramic	PTFE	PE 3/8" O.D.		RPM-353	\$ 317
368	PVC	PVC	Ceramic	Polyprel®	PE 3/8" O.D.		RPM-352/358	\$ 233
AutoPrime™								
D60	Acrylic	PVC	Ceramic	Polyprel®	PE 3/8" O.D.		RPM-D68	\$ 341
D68	PVC	PVC	Ceramic	Polyprel®	PE 3/8" O.D.		RPM-D68	\$ 335
Valve Code	Compatible with				Valve			
S	Liquipro™				4FV		\$ 64	
T	Liquipro™				3FV		\$ -	
H	AutoPrime™				4FV		\$ 127	
A	AutoPrime™				-		\$ 64	
-	316SS Liquipro™ Head only				-		\$ -	
Connection Code								
I	Inch Tube connections with tubing - also includes 1/2" NPT and 1/2" BSP connection							\$ -
-	1/4" NPT M (Only available with 316SS Liquipro™ Head)							\$ -
P06	1	- 460	S	I				

RPM Kit	Price	Contents
Liquipro™ - Machined		
RPM-362/368	\$ 145	*O-Rings
RPM-465	\$ 155	*Hardware kit
RPM-460F	\$ 155	*Shaft Seal
Liquipro™ - Molded		
RPM-352/358	\$ 135	*Check Valve Cartridges
RPM-353	\$ 150	*Liquifram
		*Injection Valve Cartridge
AutoPrime™		
RPM-D68	\$ 180	*O Rings
		*Shaft Seal
		*Liquifram
		*Check Valve Cartridges
		*Injection Valve Cartridge
		*AutoPrime Cartridge

AUTOPRIME™ heads have 3 check valves: Suction on the bottom; Discharge on the front; AUTOPRIME™ bleed on the top. By design, a repeatable portion of the process fluid continuously bleeds through the top check valve to be returned to the chemical supply. The result is the assurance that any gas in the head is automatically relieved thus eliminating air-binding.

SERIES J METERING PUMPS

12 VDC Powered



Output Code	Max Output		Max Pressure	
	GPH	LPH	PSI	Bar
4	0.42	1.6	140	9.7
5	1.0	3.8	60	4.1
6	2.0	7.6	20	1.4

For support:

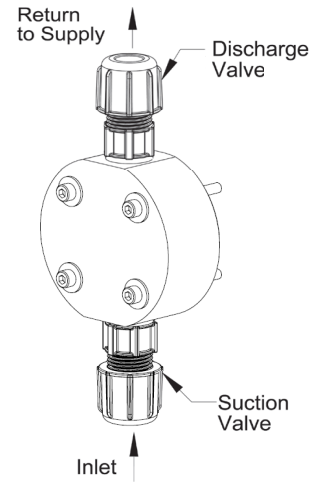

LiquiPro™
Standard Liquid End
suitable for most
applications

Control Code

Key Features	J7
Stroke length manually adjustable	✓
Stroke frequency manually adjustable	✓
External control via pulse input	✓
Manual/External mode selection	✓



4 Function Valve

- This diaphragm type, anti-syphon/pressure relief valve is installed on the pump head.
- Can be oriented as required (360°) at precisely the desired position.
- Easier to use thanks to the more user-friendly design of the priming knobs and back pressure valve

What's in the Box

Series J units include:



Tube Connection Hardware



Quick Start Guide



Suction/Discharge Tubing



Injection Check Valve



Foot Valve



Ceramic Weight

Stainless Steel LE units

SERIES J PUMP SELECTION AND PRICING

OUTPUT CODE 4

Size Code 0.5

0.01 - 0.42 GPH (0.02 - 1.6 LPH); 140 psi (9.7 bar)

J54D

Drive End							Price
Control							
J54 Manual Control							\$ 464
Power Code		Voltage					
D		12 VDC Powered					\$ -
Liquid End	Head	Fittings	Balls	Cartridge Valve	RPM Kit		
Liquipro™							
352	PVDF	PVDF	Ceramic	PVDF / Polyprel®	RPM-352/358		\$ 263
353	PVDF	PVDF	Ceramic	PVDF / PTFE	RPM-353		\$ 304
358	PVC	PVC	Ceramic	PVDF/ Polyprel®	RPM-352/358		\$ 220
450	Acrylic	PVC	Ceramic	PVDF/ Polyprel®	RPM-352/358		\$ 328
458	PVC	PVC	Ceramic	PVDF/ Polyprel®	RPM-352/358		\$ 322
LMI							
297	316 SS	316 SS	316 SS	316 SS	-		\$ 539
Valve & Connection Code		Compatible with		Valve	Tubing & Connections		
SI		Liquipro™		4FV	PE 1/4" O.D.		\$ 64
TI		Liquipro™		3FV	PE 1/4" O.D.		\$ -
-		316SS LMI Head only		-	Pipe 1/4" NPT M		\$ -
J54	D	-352	SI				

RPM Kit	Price	Contents
Liquipro™		
RPM-352/358	\$ 135	*O-Rings *Shaft Seal
RPM-353	\$ 150	*Ball, Seat, Spring *Hardware kit *Liquifram *Injection Valve Cartridge



SERIES J PUMP SELECTION AND PRICING

OUTPUT CODE 5

Size Code 0.9

0.01 - 1.0 GPH (0.04 - 3.8 LPH); 60 psi (4.1 bar)

J55D							
Drive End						Price	
Control							
J55	Manual Control					\$	464
Power Code						Voltage	
D						12 VDC Powered	
	Liquid End	Head	Fittings	Balls	Cartridge Valve	RPM Kit	
	Liquipro™						
	392	PVDF	PVDF	Ceramic	PVDF / Polyprel®	RPM-392/398	
	393	PVDF	PVDF	Ceramic	PVDF / PTFE	RPM-393	
	398	PVC	PVC	Ceramic	PVDF/ Polyprel®	RPM-392/398	
	490	Acrylic	PVC	Ceramic	PVDF/ Polyprel®	RPM-392/398	
	498	PVC	PVC	Ceramic	PVDF/ Polyprel®	RPM-392/398	
	LMI						
	297	316 SS	316 SS	316 SS	316SS	-	
	Valve & Connection Code		Compatible with		Valve	Tubing & Connections	
	SI		Liquipro™		4FV	PE 1/4" O.D.	
	TI		Liquipro™		3FV	PE 1/4" O.D.	
	-		316SS LMI Head only		-	Pipe 1/4" NPT M	
J55	D	-392	SI				

RPM Kit	Price	Contents
Liquipro™		
RPM-392/398	\$ 140	*O-Rings *Shaft Seal
RPM-393	\$ 160	*Ball, Seat, Spring *Hardware kit *Liquifram *Injection Valve Cartridge



SERIES J PUMP SELECTION AND PRICING

OUTPUT CODE 6

Size Code 1.8

0.02 - 2.0 GPH (0.08 - 7.6 LPH); 20 psi (1.4 bar)

J56D

Drive End							Price
Control							
J56 Manual Control							\$ 492
Power Code		Voltage					
D		12 VDC Powered					\$ -
	Liquid End	Head	Fittings	Balls	Cartridge Valve	RPM Kit	
	Liquipro™						
	362	PVDF	PVDF	Ceramic	PVDF / Polyprel®	RPM-362/368	\$ 276
	363	PVDF	PVDF	Ceramic	PVDF / PTFE	RPM-363	\$ 317
	368	PVC	PVC	Ceramic	PVDF/ Polyprel®	RPM-362/368	\$ 233
	460	Acrylic	PVC	Ceramic	PVDF/ Polyprel®	RPM-362/368	\$ 341
	468	PVC	PVC	Ceramic	PVDF/ Polyprel®	RPM-362/368	\$ 335
	LMI						
	297	316 SS	316 SS	316 SS	316 SS	-	\$ 539
	Valve & Connection Code		Compatible with		Valve	Tubing & Connections	
	TI		Liquipro™		3FV	PE 3/8" O.D.	\$ -
	-		316SS LMI Head only		-	Pipe 1/4" NPT M	\$ -
J56	D	-362	TI				

RPM Kit	Price	Contents
Liquipro™		
RPM-362/368	\$ 145	*O-Rings *Shaft Seal
RPM-363	\$ 170	*Ball, Seat, Spring *Hardware kit *Liquifram *Injection Valve Cartridge



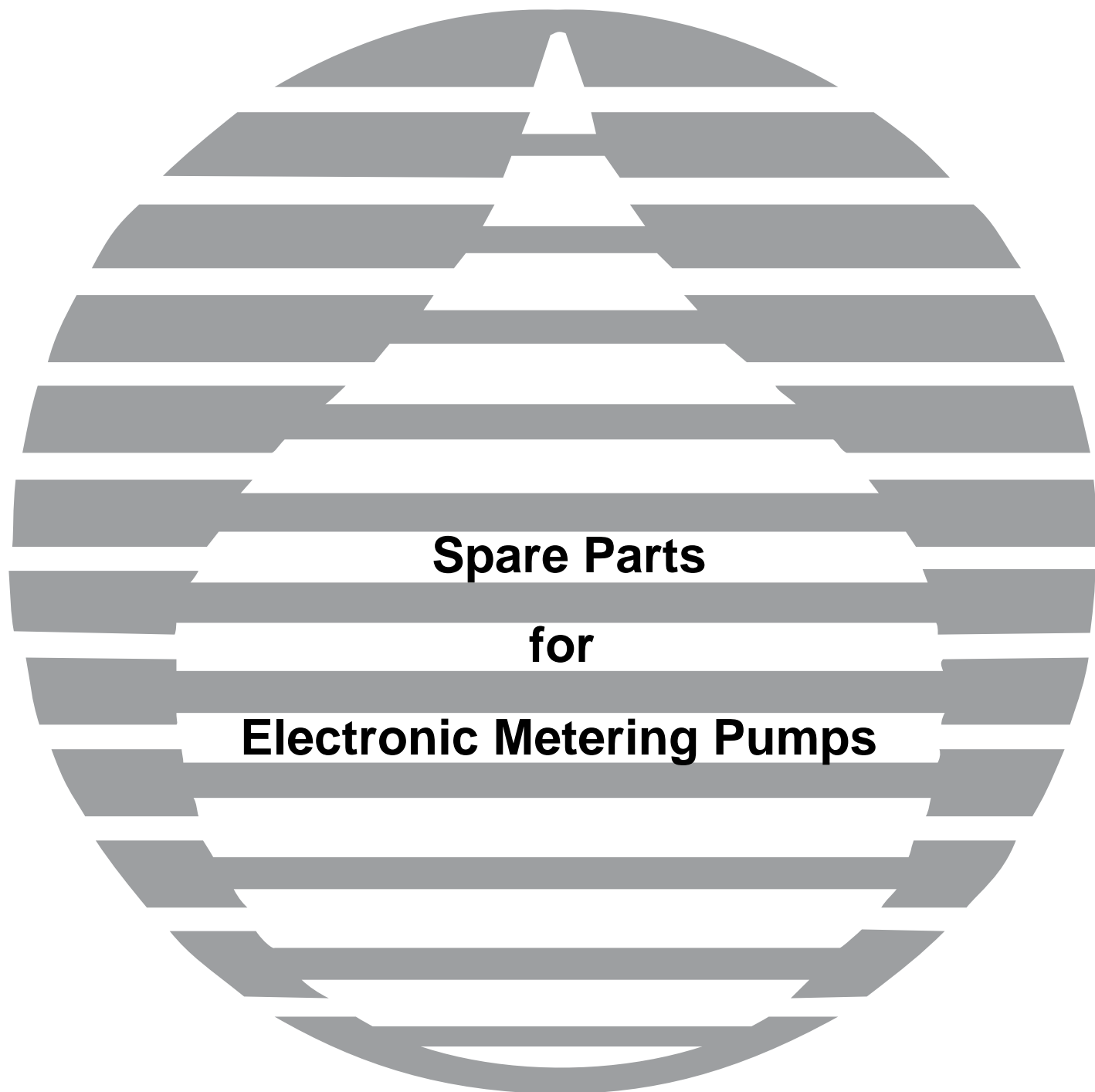

ROUTINE PREVENTATIVE MAINTENANCE (RPM) KITS

FASTPRIME® Liquid End RPM Kits

RPM Kit	For Liquid End Assembly	Price
RPM-718	718xx	\$ 115
RPM-728	728xx	\$ 120
RPM-738	738xx	\$ 125
RPM-748	748xx	\$ 130
RPM-812	812xx, 818xx, 910Nx, 910Sx	\$ 135
RPM-813	813xx, 915xx	\$ 150
RPM-822	822xx, 828xx, 920Nx, 920Sx	\$ 140
RPM-823	823xx, 925xx	\$ 160
RPM-832	832xx, 838xx, 930Nx, 930Sx	\$ 145
RPM-833	833xx, 935xx	\$ 170
RPM-842	842xx, 848xx, 940Nx, 940Sx	\$ 150
RPM-843	843xx, 945xx	\$ 180
RPM-907	907NP	\$ 260
RPM-917	917NP	\$ 260
RPM-919	919xx	\$ 135
RPM-927	927NP	\$ 270
RPM-929	929xx	\$ 140
RPM-937	937NP	\$ 280
RPM-939	939xx	\$ 145
RPM-947	947NP	\$ 290
RPM-949	949xx	\$ 150

LIQUIPRO™ Liquid End RPM Kits

RPM Kit	For Liquid End Assembly	Price
RPM-312/318	312xx, 318xx, 410xx, 418xx	\$ 150
RPM-313	313xx	\$ 180
RPM-352/358	352xx, 358xx, 450xx, 458xx	\$ 135
RPM-353	353xx	\$ 150
RPM-362/368	362xx, 368xx, 460xx, 468xx	\$ 145
RPM-363	363xx	\$ 170
RPM-392/398	392xx, 398xx, 490xx, 498xx	\$ 140
RPM-393	393xx	\$ 160
RPM-410F	410FI, 410xx	\$ 165
RPM-415	415xx	\$ 165
RPM-450F	450FI, 459xx	\$ 135
RPM-455	455xx	\$ 135
RPM-460F	460FI, 469xx	\$ 155
RPM-465	465xx	\$ 155
RPM-490F	490FI, 499xx	\$ 145
RPM-495	495xx	\$ 145
RPM-D18	D10xx, D18xx	\$ 190
RPM-D58	D50xx, D58xx,	\$ 160
RPM-D68	D60xx, D68xx	\$ 180
RPM-D98	D90xx, D98xx	\$ 170

High Viscosity Liquid End RPM Kits

RPM Kit	For Liquid End Assembly	Price
RPM-624	624xx	\$ 130
RPM-626	626xx	\$ 130
RPM-634	634xx	\$ 140
RPM-636	636xx	\$ 140
RPM-644	644xx	\$ 150
RPM-646	646xx	\$ 150

AUTOPRIME® Liquid End RPM Kits

RPM Kit	For Liquid End Assembly	Price
RPM-910A	910Ax, 910Hx, 918Ax, 918Hx	\$ 155
RPM-920A	920Ax, 920Hx, 928Ax, 928Hx	\$ 160
RPM-930A	930Ax, 930Hx, 938Ax, 938Hx	\$ 165
RPM-A10A	A10Ax, A10Hx, A18Ax, A18Hx	\$ 160
RPM-A20A	A20Ax, A20Hx, A28Ax, A28Hx	\$ 170
RPM-A30A	A30Ax, A30Hx, A38Ax, A38Hx	\$ 180
RPM-A40A	A40Ax, A40Hx, A48Ax, A48Hx	\$ 190

OTHER Liquid Handling Assemblies

RPM Kit	For Liquid End Assembly	Price
SP-U1	81S, 81T, 82T, 85S, 85T, 91S, 91T, 92S, 92T, 94, 94S, 95S, 95T, 196, 196S	\$ 160
SP-U2	65, 65S, 71S, 71T, 72S, 72S, 72T, 74, 74S, 75S, 75T	\$ 160
SP-U3	81FS, 91FS	\$ 160
SP-U4	71FS	\$ 160
SP-U5	24, 25P, 25T	\$ 210
SP-U6	30, 30S, 32, 34, 35P, 35T, 36, 36S	\$ 250
SP-U7	190, 190S, 191, 191S, 192, 192S, 193, 193S, 198, 198S	\$ 160
SP-U8	150, 150S, 151, 151P, 151S, 152, 152S, 158	\$ 160
SP-U9	155, 155P, 155S	\$ 160
SP-U10	61, 62, 62S, 161, 162, 168, 168S, 171, 171S, 172, 172S	\$ 160
SP-U17	12, 12S, 112, 112S, 118, 118S	\$ 180
SP-15	15, 15S	\$ 180
SP-20	20, 20S	\$ 140
SP-20HV	20HV	\$ 180
SP-25HV	25HV, 20PB, 20PBA	\$ 180
SP-26	26, 26S	\$ 220
SP-27	27	\$ 170
SP-29	29	\$ 180
SP-30HV	30HV	\$ 162

OTHER Liquid Handling Assemblies

RPM Kit	For Liquid End Assembly	Price
SP-35HV	35HV	\$ 180
SP-37	37	\$ 190
SP-66PB	66PB	\$ 160
SP-75HV	75HV	\$ 160
SP-75V	75V	\$ 160
SP-76	76HV	\$ 150
SP-76PB	76PB	\$ 160
SP-77	77	\$ 160
SP-79	79	\$ 160
SP-85HV	85HV, 86PBA	\$ 160
SP-86	86HV	\$ 150
SP-86PB	86PB	\$ 160
SP-89	89	\$ 160
SP-92V	92V	\$ 160
SP-97	97	\$ 160
SP-151FS	151FS	\$ 160
SP-155HV	155HV, 156PB, 156PBA	\$ 160
SP-156	156HV	\$ 160
SP-157	157	\$ 160
SP-987	987	\$ 880

PUMP DRIVE ASSEMBLIES

Drive	Size Code	Output		Pressure		Price
		GPH	LPH	PSI	Bar	
Series PD						
PD01x	0	0.10 to 0.25	0.38 to 0.95	450	30.6	\$ 315
PD71x	0	0.10 to 0.25	0.38 to 0.95	450	30.6	\$ 540
PD04x	2	0.35 to 0.68	1.32 to 2.60	250	17.3	\$ 315
PD74x	2	0.35 to 0.68	1.32 to 2.60	250	17.3	\$ 540
PD05x	3	0.80 to 1.10	3.00 to 4.20	150	10.3	\$ 315
PD75x	3	0.80 to 1.10	3.00 to 4.20	150	10.3	\$ 540
PD06x	4	1.70 to 1.85	6.40 to 7.60	70	4.8	\$ 315
PD76x	4	1.70 to 1.85	6.40 to 7.60	70	4.8	\$ 540

EXCEL AD						
AD21x	1	0.002 to 0.21	0.01 to 0.8	250	17.2	\$ 663
AD24x	2	0.005 to 0.50	0.02 to 1.9	250	17.2	\$ 663
AD25x	3	0.010 to 1.00	0.04 to 3.8	110	7.6	\$ 663
AD26x	4	0.020 to 2.00	0.08 to 7.6	50	3.4	\$ 699
AD81x	1	0.002 to 0.21	0.01 to 0.8	250	17.2	\$ 857
AD84x	2	0.005 to 0.50	0.02 to 1.9	250	17.2	\$ 857
AD85x	3	0.010 to 1.00	0.04 to 3.8	110	7.6	\$ 857
AD86x	4	0.020 to 2.00	0.08 to 7.6	50	3.4	\$ 893
AD91x	1	0.002 to 0.21	0.01 to 0.8	250	17.2	\$ 1,084
AD94x	2	0.005 to 0.50	0.02 to 1.9	250	17.2	\$ 1,084
AD95x	3	0.010 to 1.00	0.04 to 3.8	110	7.6	\$ 1,084
AD96x	4	0.020 to 2.00	0.08 to 7.6	50	3.4	\$ 1,120

SERIES B						
B11x	0.9	0.01 to 1.60	0.05 to 6.10	150	10.3	\$ 859
B12x	0.9	0.01 to 2.50	0.05 to 9.50	100	6.9	\$ 859
B13x	1.8	0.02 to 4.50	0.09 to 17.0	50	3.4	\$ 859
B14x	3.0	0.04 to 7.00	0.13 to 26.5	30	2.07	\$ 918
B71x	0.9	0.00 to 1.60	0.00 to 6.10	150	10.3	\$ 964
B72x	0.9	0.00 to 2.50	0.00 to 9.50	100	6.9	\$ 964
B73x	1.8	0.00 to 4.50	0.00 to 17.0	50	3.4	\$ 964
B74x	3.0	0.00 to 7.00	0.00 to 26.5	30	2.07	\$ 1,023
B91x	0.9	0.00 to 1.60	0.00 to 6.10	150	10.3	\$ 1,300
B92x	0.9	0.00 to 2.50	0.00 to 9.50	100	6.9	\$ 1,300
B93x	1.8	0.00 to 4.50	0.00 to 17.0	50	3.4	\$ 1,300
B94x	3.0	0.00 to 7.00	0.00 to 26.5	30	2.07	\$ 1,359

SERIES P						
P02x	0.5	0.06 to 0.21	0.24 to 0.79	150	10.3	\$ 203
P03x	0.9	0.13 to 0.42	0.48 to 1.60	110	7.6	\$ 203
P04x	0.5	0.12 to 0.58	0.44 to 2.20	250	17.3	\$ 230
P05x	0.9	0.20 to 1.00	0.76 to 3.80	110	7.6	\$ 230
P06x	1.8	0.40 to 2.00	1.52 to 7.60	50	3.4	\$ 253
P12x	0.5	0.003 to 0.21	0.01 to 0.79	150	10.3	\$ 289
P13x	0.9	0.01 to 0.42	0.02 to 1.60	110	7.6	\$ 289
P14x	0.5	0.01 to 0.58	0.02 to 2.20	250	17.3	\$ 316
P15x	0.9	0.01 to 1.00	0.04 to 3.80	110	7.6	\$ 316
P16x	1.8	0.02 to 2.00	0.08 to 7.60	50	3.4	\$ 339
P74x	0.5	0.00 to 0.58	0.00 to 2.20	250	17.3	\$ 433
P75x	0.9	0.00 to 1.00	0.00 to 3.80	110	7.6	\$ 433
P76x	1.8	0.00 to 2.00	0.00 to 7.60	50	3.4	\$ 456

Drive	Size Code	Output		Pressure		Price
		GPH	LPH	PSI	Bar	
SERIES C						
C10x	0.9	0.01 to 1.30	0.03 to 4.90	300	20.7	\$ 1,236
C11x	1.8	0.01 to 2.50	0.05 to 9.50	150	10.3	\$ 1,236
C12x	1.8	0.02 to 4.00	0.08 to 15.1	100	6.9	\$ 1,236
C13x	3.0	0.05 to 8.00	0.17 to 30.3	60	4.1	\$ 1,236
C14x	6.0	0.1 to 20.00	0.38 to 76.0	25	1.8	\$ 1,379
C70x	0.9	0.00 to 1.30	0.00 to 4.90	300	20.7	\$ 1,337
C71x	1.8	0.00 to 2.50	0.00 to 9.50	150	10.3	\$ 1,337
C72x	1.8	0.00 to 4.00	0.00 to 15.1	100	6.9	\$ 1,337
C73x	3.0	0.00 to 8.00	0.00 to 30.3	60	4.1	\$ 1,337
C74x	6.0	0.00 to 20.0	0.00 to 76.0	25	1.8	\$ 1,480
C76x	1.8	0.00 to 4.00	0.00 to 15.1	175	12.1	\$ 1,551
C77x	3.0	0.00 to 10.0	0.00 to 38.0	80	5.5	\$ 1,551
C78x	6.0	0.00 to 25.0	0.00 to 95.0	30	2.07	\$ 1,697
C90x	0.9	0.00 to 1.30	0.00 to 4.90	300	20.7	\$ 1,688
C91x	1.8	0.00 to 2.50	0.00 to 9.50	150	10.3	\$ 1,688
C92x	1.8	0.00 to 4.00	0.00 to 15.1	100	6.9	\$ 1,688
C93x	3.0	0.00 to 8.00	0.00 to 30.3	60	4.1	\$ 1,688
C94x	6.0	0.00 to 20.0	0.00 to 76.0	25	1.8	\$ 1,831

SERIES E						
E70x	0.9	0.00 to 1.30	0.00 to 4.90	300	20.7	\$ 3,159
E71x	1.8	0.00 to 2.50	0.00 to 9.50	150	10.3	\$ 3,159
E72x	1.8	0.00 to 4.00	0.00 to 15.1	100	6.9	\$ 3,159
E73x	3.0	0.00 to 8.00	0.00 to 30.3	60	4.1	\$ 3,159
E74x	6.0	0.00 to 20.0	0.00 to 76.0	25	1.7	\$ 3,304

Roytronic A						
A11x	1	0.003 to 0.2	0.03 to 1.0	250	17.2	\$ 497
A14x	1	0.005 to 0.5	0.02 to 1.9	250	17.2	\$ 497
A15x	2	0.010 to 1.0	0.04 to 3.8	110	7.6	\$ 497
A16x	3	0.020 to 2.0	0.08 to 7.6	50	3.4	\$ 533
A71x	1	0.003 to 0.2	0.03 to 1.0	250	17.2	\$ 589
A74x	1	0.005 to 0.5	0.02 to 1.9	250	17.2	\$ 589
A75x	2	0.010 to 1.0	0.04 to 3.8	110	7.6	\$ 589
A76x	3	0.020 to 2.0	0.08 to 7.6	50	3.4	\$ 625
A81x	1	0.003 to 0.2	0.03 to 1.0	250	17.2	\$ 653
A84x	1	0.005 to 0.5	0.02 to 1.9	250	17.2	\$ 653
A85x	2	0.010 to 1.0	0.04 to 3.8	110	7.6	\$ 653
A86x	3	0.020 to 2.0	0.08 to 7.6	50	3.4	\$ 689

SERIES J						
J54D	0.5	0.01 to 0.42	0.02 to 1.60	140	9.7	\$ 464
J55D	0.9	0.01 to 1.00	0.04 to 3.80	60	4.1	\$ 464
J56D	1.8	0.02 to 2.00	0.08 to 7.60	20	1.4	\$ 492

NOTE: To complete the Drive, change the "x" to one of the following:

- 1- 120 V AC USA Plug
- 2- 240 V AC USA Plug (not for export)
- 3- 220-240V AC, DIN plug
- 5- 240-250V AC, UK Plug
- 6- 240-250V AC, Aust/NZ Plug

Liquid End Assemblies (LE's)

FASTPRIME™ Heads

Liquid End	Size Code	Price
LE-812NI	1	\$ 263
LE-812SI	1	\$ 327
LE-813NI	1	\$ 304
LE-813SI	1	\$ 368
LE-818NI	1	\$ 220
LE-818SI	1	\$ 284
LE-822NI	2*	\$ 275
LE-822SI	2*	\$ 339
LE-823NI	2*	\$ 316
LE-823SI	2*	\$ 380
LE-828NI	2*	\$ 232
LE-828SI	2*	\$ 296
LE-832NI	3	\$ 275
LE-832SI	3	\$ 339
LE-833NI	3	\$ 316
LE-833SI	3	\$ 380
LE-838NI	3	\$ 232
LE-838SI	3	\$ 296
LE-842NI	4	\$ 275
LE-842SI	4	\$ 339
LE-843NI	4	\$ 316
LE-843SI	4	\$ 380
LE-848NI	4	\$ 232
LE-848SI	4	\$ 296
LE-907NP	0	\$ 260
LE-910NI	1	\$ 328
LE-910SI	1	\$ 392
LE-915NI	1	\$ 331
LE-915SI	1	\$ 395
LE-917NP	1	\$ 526
LE-918NI	1	\$ 322
LE-918SI	1	\$ 386
LE-919NI	1	\$ 341
LE-919SI	1	\$ 405
LE-920NI	2*	\$ 340
LE-920SI	2*	\$ 404
LE-925NI	2*	\$ 343
LE-925SI	2*	\$ 407
LE-927NP	2*	\$ 538
LE-928NI	2*	\$ 334
LE-928SI	2*	\$ 398
LE-929NI	2*	\$ 353
LE-929SI	2*	\$ 417
LE-930NI	3	\$ 340
LE-930SI	3	\$ 404
LE-935NI	3	\$ 343
LE-935SI	3	\$ 407
LE-937NP	3	\$ 538
LE-938NI	3	\$ 334
LE-938SI	3	\$ 398
LE-939NI	3	\$ 353
LE-939SI	3	\$ 417
LE-940NI	4	\$ 340
LE-940SI	4	\$ 404
LE-945NI	4	\$ 343
LE-945SI	4	\$ 407
LE-947NP	4	\$ 538
LE-948NI	4	\$ 334
LE-948SI	4	\$ 398
LE-949NI	4	\$ 353
LE-949SI	4	\$ 417

AUTOPRIME™ Heads

For off-gassing fluids

Liquid End	Size Code	Price
LE-910AI	1	\$ 392
LE-910HI	1	\$ 455
LE-918AI	1	\$ 386
LE-918HI	1	\$ 449
LE-920AI	2*	\$ 404
LE-920HI	2*	\$ 467
LE-928AI	2*	\$ 398
LE-928HI	2*	\$ 461
LE-930AI	3	\$ 404
LE-930HI	3	\$ 467
LE-938AI	3	\$ 398
LE-938HI	3	\$ 461
LE-A10AI	1	\$ 392
LE-A10HI	1	\$ 455
LE-A18AI	1	\$ 386
LE-A18HI	1	\$ 449
LE-A20AI	2*	\$ 404
LE-A20HI	2*	\$ 467
LE-A28AI	2*	\$ 398
LE-A28HI	2*	\$ 461
LE-A30AI	3	\$ 404
LE-A30HI	3	\$ 467
LE-A38AI	3	\$ 398
LE-A38HI	3	\$ 461
LE-A40AI	4	\$ 404
LE-A40HI	4	\$ 467
LE-A48AI	4	\$ 398
LE-A48HI	4	\$ 461

***NOTE:** Size 2 FastPrime LE's come on two different model pumps rated for different pressures. To get the correct accessories, include pump pressure rating in code for size 2 liquid ends. Rating will be 150 or 250 psi. Code example: LE-828NI-250. If pressure is not noted in the order, LMI will default to the 150 psi product.

High Viscosity

Liquid End	Size Code	Price
LE-624VI	2	\$ 416
LE-624VP	2	\$ 416
LE-624PI	2	\$ 441
LE-624PP	2	\$ 441
LE-626VI	2	\$ 413
LE-634VI	3	\$ 416
LE-634VP	3	\$ 416
LE-634PI	3	\$ 441
LE-634PP	3	\$ 441
LE-636VI	3	\$ 413
LE-644VI	4	\$ 416
LE-644VP	4	\$ 416
LE-644PI	4	\$ 441
LE-644PP	4	\$ 441
LE-646VI	4	\$ 413

LIQUIPRO™ Heads

Liquid End	Size Code	Price
LE-312NI	3	\$ 386
LE-312SI	3	\$ 450
LE-312TI	3	\$ 386
LE-313NI	3	\$ 427
LE-313SI	3	\$ 491
LE-313TI	3	\$ 427
LE-318NI	3	\$ 343
LE-318SI	3	\$ 407
LE-318TI	3	\$ 343
LE-352NI	0.5	\$ 263
LE-352SI	0.5	\$ 327
LE-352TI	0.5	\$ 263
LE-353NI	0.5	\$ 304
LE-353SI	0.5	\$ 368
LE-353TI	0.5	\$ 304
LE-358NI	0.5	\$ 220
LE-358SI	0.5	\$ 284
LE-358TI	0.5	\$ 220
LE-362NI	1.8	\$ 276
LE-362SI	1.8	\$ 340
LE-362TI	1.8	\$ 276
LE-363NI	1.8	\$ 317
LE-363SI	1.8	\$ 381
LE-363TI	1.8	\$ 317
LE-368NI	1.8	\$ 233
LE-368SI	1.8	\$ 297
LE-368TI	1.8	\$ 233
LE-392NI	0.9	\$ 276
LE-392SI	0.9	\$ 340
LE-392TI	0.9	\$ 276
LE-393NI	0.9	\$ 317
LE-393SI	0.9	\$ 381
LE-393TI	0.9	\$ 317
LE-398NI	0.9	\$ 233
LE-398SI	0.9	\$ 297
LE-398TI	0.9	\$ 233
LE-410NI	3	\$ 451
LE-410SI	3	\$ 515
LE-410TI	3	\$ 451
LE-418NI	3	\$ 445
LE-418SI	3	\$ 509
LE-418TI	3	\$ 445
LE-419SI	3	\$ 528
LE-450NI	0.5	\$ 328
LE-450SI	0.5	\$ 392
LE-450TI	0.5	\$ 328
LE-455NI	0.5	\$ 331
LE-455SI	0.5	\$ 395
LE-458NI	0.5	\$ 322
LE-458SI	0.5	\$ 386
LE-458TI	0.5	\$ 322
LE-459SI	0.5	\$ 405
LE-460NI	1.8	\$ 341
LE-460SI	1.8	\$ 405
LE-460TI	1.8	\$ 341
LE-465NI	1.8	\$ 344
LE-465SI	1.8	\$ 408
LE-468NI	1.8	\$ 335
LE-468SI	1.8	\$ 399
LE-468TI	1.8	\$ 335
LE-469SI	1.8	\$ 418
LE-490NI	0.9	\$ 341
LE-490SI	0.9	\$ 405
LE-490TI	0.9	\$ 341
LE-495NI	0.9	\$ 344
LE-495SI	0.9	\$ 408
LE-498NI	0.9	\$ 335
LE-498SI	0.9	\$ 399
LE-498TI	0.9	\$ 335
LE-499SI	0.9	\$ 418

AUTOPRIME™ Heads

For off-gassing fluids

Liquid End	Size Code	Price
LE-D10AI	3	\$ 515
LE-D10HI	3	\$ 578
LE-D18AI	3	\$ 509
LE-D18HI	3	\$ 572
LE-D50AI	0.5	\$ 392
LE-D50HI	0.5	\$ 455
LE-D58AI	0.5	\$ 386
LE-D58HI	0.5	\$ 449
LE-D60AI	1.8	\$ 405
LE-D60HI	1.8	\$ 468
LE-D68AI	1.8	\$ 399
LE-D68HI	1.8	\$ 462
LE-D90AI	0.9	\$ 405
LE-D90HI	0.9	\$ 468
LE-D98AI	0.9	\$ 399
LE-D98HI	0.9	\$ 462

LMI Liquid Ends

Liquid End	Size Code	Price
LE-20HV	3	\$ 564
LE-20S	3	\$ 586
LE-24	3	\$ 510
LE-25HV	3	\$ 564
LE-25P	3	\$ 540
LE-25T	3	\$ 430
LE-26	3	\$ 464
LE-26S	3	\$ 581
LE-27	3	\$ 1,508
LE-30	6	\$ 597
LE-30HV	6	\$ 692
LE-30S	6	\$ 713
LE-34	6	\$ 636
LE-35HV	6	\$ 692
LE-35P	6	\$ 669
LE-35T	6	\$ 623
LE-36	6	\$ 592
LE-36S	6	\$ 708
LE-37	6	\$ 1,672
LE-75HV	1.8	\$ 430
LE-76HV	1.8	\$ 430
LE-85HV	0.9	\$ 430
LE-86HV	0.9	\$ 430
LE-155HV	0.5	\$ 418
LE-156HV	0.5	\$ 418
LE-217	3	\$ 539
LE-257	0.5	\$ 526
LE-277	1.8	\$ 539
LE-297	0.9	\$ 539

NOTE: EXCEL™ XR and Series G liquid ends are detailed in their respective sections

ACCESSORIES

Agitators		
Part No.	Description	Price
34504	Agitator, 27" SS Shaft & Impeller, 230V	\$ 581
27591	Agitator, 27" SS Shaft & Impeller, 115V	\$ 565
10590	Agitator, 34" SS Shaft & Impeller, 115V	\$ 583
25290	Agitator, 34" SS Shaft & Impeller, 230V	\$ 592
10592	Agitator, 34" SS Shaft, Neoprene® Impeller, 115V	\$ 665
25292	Agitator, 34" SS Shaft, Neoprene® Impeller, 230V	\$ 683

Corp Stop and Nozzle Assembly		
Part No.	Description	Price
49290	1" Mueller Bronze Corp Stop Assembly with PP Nozzle Assembly (replaces P/N 27741)	\$ 340
49289	1" NPT Bronze Corp Stop with Carpenter 20 Nozzle Assembly (replaces P/N 26741)	\$ 580
49288	1" NPT Bronze Corp Stop with PP Nozzle Assembly (replaces P/N 10741)	\$ 380
49287	3/4" NPT Bronze Corp Stop Assembly with CPVC Nozzle Assembly (replaces P/N 10998)	\$ 350

Covers		
Part No.	Description	Price
48165	Clear Cover for ROYTRONIC® Series A	\$ 12
48603	Clear Cover for ROYTRONIC EXCEL™ AD	\$ 17

Calibration Cylinders		
Part No.	Description	Price
35643	Calibration Cylinder, 200 ml, Sealed Top	\$ 160
35644	Calibration Cylinder, 1000 ml, Sealed Top	\$ 175
35860	Calibration Cylinder, 4000 ml, Sealed Top	\$ 379
35645	Calibration Cylinder, 200 ml, EZ Clean	\$ 122
35710	Calibration Cylinder, 1000 ml, EZ Clean	\$ 169
35861	Calibration Cylinder, 4000 ml, EZ Clean	\$ 365

Digi-Pulse Flow Monitors		
Part No.	Description	Price
FM-250	Digi-Pulse Flow Monitor for Legacy Liquid Ends with 3/8" Check Balls. Replaces FM-200, FM-201, FM-202, FM-203, FM-204	\$ 319
FM-259	Same as FM-250 w/ 3.5mm connector. Replaces FM-200-9	\$ 352
FM-350	For Legacy Liquid Ends with 1/2" Check Balls. Replaces FM-301 & FM-302	\$ 319
FM-359	Same as FM-350 w/ 3.5mm connector. Replaces FM-301-9 & FM302-9	\$ 352
FM-450	For 300 and 400 series LIQUIPRO liquid ends. Replaces FM-PRO	\$ 319
FM-459	Same as FM-450 w/ 3.5 mm connector. Replaces FM-PRO-9	\$ 352
FM-850	For 800 and 900 series FASTPRIME liquid ends. Replaces FM-ROY	\$ 319
FM-859	Same as FM-850 w/ 3.5mm connector. Replaces FM-ROY-1	\$ 352
FM-879	Same as FM-850 w/ 4 pin connector. Replaces FM-ROY-9	\$ 352

Pump Mounting Accessories		
Part No.	Description	Price
10461	Pump Mounting Kit	\$ 28
34643	Polypropylene Wall Bracket Asm w/ mounting hardware	\$ 85

UV Resistant Tubing		
Part No.	Description	Price
54783	Tubing, UV Kit, 1/4"	\$ 26
54784	Tubing, UV Kit, 3/8"	\$ 50
54793	Tubing, UV Kit, 1/2"	\$ 57

Extension Cable Assemblies (non-ROYTRONIC)		
Part No.	Description	Price
26034-20	Cable Asm, 4-Pin Extension 20'	\$ 90
26034-50	Cable Asm, 4-Pin Extension 50'	\$ 150
31396-25	Cable Asm, 8-Pin Extension 25'	\$ 325

Ferrule Bulk Kit (50 Ferrules each kit) - for Tubing Connection System		
Part No.	Description	Price
50508	Ferrule Kit 1/4", BULK	\$ 55
50509	Ferrule Kit 3/8", BULK	\$ 110
50510	Ferrule Kit 1/2", BULK	\$ 110

Fluoride Saturator		
Part No.	Description	Price
28850	Upflow Fluoride Saturator with 50 Gallon Tank	\$ 2,750

Head Screw Kit		
Part No.	Description	Price
37144	Kit, Hastelloy C head screws [4], 10-24 x 0.75	\$ 127
38735	Kit, Hastelloy C head screws [4], 10-24 x 1.25	\$ 130

Liquid Level and Low Level Switches		
Part No.	Description	Price
29190	Liquid Level Shutoff Switch for Series AA7, B7, C7	\$ 107
27417	LL Switch Asm w/Outlets for P&A - 35 Gal Tank, 115V	\$ 480
26731	LL Switch Asm w/Outlets for P&A - 50 Gal Tank, 115V	\$ 522
26732	LL Switch Asm w/Outlets for P&A - 50 Gal Tank, 230V, US Plug	\$ 542
33510	LL Switch Asm w/Outlets for P&A - 35 Gal Tank, 230V, US Plug	\$ 500
49246	Low Level Shutoff Switch for Roytronic A, Excel AD2	\$ 240
49249	Switch, Dual Liquid Level - Excel AD8 & AD9	\$ 280

Micropace™ Control Modules		
Part No.	Description	Price
MP-100	Analog to Digital converter	\$ 240
MP-400D	4 Digit Divider	\$ 280
MP-500M	4 Digit Multiplier	\$ 320

Pressure Relief Valves / Back Pressure Valves		
Part No.	Description	Price
35635	Pressure Relief, 1/4" PVC	\$ 250
35636	Pressure Relief, 1/4" PP	\$ 272
35844	Pressure Relief, 1/4" PVDF	\$ 928
35845	Pressure Relief, 1/4" SS	\$ 850
35639	Pressure Relief, 1/2" PVC	\$ 250
35640	Pressure Relief, 1/2" PP	\$ 250
35848	Pressure Relief, 1/2" PVDF	\$ 1,250
35849	Pressure Relief, 1/2" SS	\$ 1,150
35852	Pressure Relief, 1" PVC	\$ 850
35853	Pressure Relief, 1" PP	\$ 746
35854	Pressure Relief, 1" PVDF	\$ 1,500
35855	Pressure Relief, 1" SS	\$ 1,400
35637	Back Pressure, 1/4" PVC	\$ 292
35638	Back Pressure, 1/4" PP	\$ 601
35846	Back Pressure, 1/4" PVDF	\$ 912
35847	Back Pressure, 1/4" SS	\$ 812
35641	Back Pressure, 1/2" PVC	\$ 243
35642	Back Pressure, 1/2" PP	\$ 257
35850	Back Pressure, 1/2" PVDF	\$ 1,010
35851	Back Pressure, 1/2" SS	\$ 907
35856	Back Pressure, 1" PVC	\$ 828
35857	Back Pressure, 1" PP	\$ 708
35858	Back Pressure 1" PVDF	\$ 1,425
35859	Back Pressure, 1" SS	\$ 1,327

Remote Programmable Flowmeter - Pulsers		
Part No.	Description	Price
RFP-075	0.22 to 22 GPM (0.83 to 83 l/m), 3/4" NPT	\$ 834.00
RFP-100	0.44 to 52 GPM (1.7 to 196 l/m), 1" NPT	\$ 1,012.00
RFP-150	0.88 to 88 GPM (3.3 to 333 l/m), 1.5" NPT	\$ 1,468.00
RFP-200	1.75 to 130 GPM (7.5 to 499 l/m), 2" NPT	\$ 1,874.00

Remote Programable Divider		
Part No.	Description	Price
31271	DIVIDER ASM, PD-4	\$ 470.00

Seal Ring Kits		
Part No.	Description	Price
25197	Kit, Seal Ring PTFE 1/2" Ball	\$ 44.00
10930	Kit, Seal Ring , PTFE 3/8" Ball	\$ 35.00
10884	Kit, Seal ring, Viton® 1/2" Ball	\$ 64.00
10928	Kit, Seal ring, Viton® 3/8" Ball	\$ 31.00
29570	Kit, Seal Ring, Polyprel® 3/8" Ball	\$ 43.00

Tank Assemblies and Accessories		
Part No.	Description	Price
27421	*Tank Assembly, 10 Gallon	\$ 200.00
27400	*Tank Assembly, 35 Gallon (Flooded Suction)	\$ 440.00
26350-1	*Tank with Cover, Drilled for Agitator	\$ 440.00
26350	*Tank Assembly, 50 Gallon	\$ 420.00

**Note: Tanks are yellow UV Resistant PE*

Tubing Connector Assemblies		
Part No.	Description	Price
26114	PP, .375" O.D. Tubing x 1/2" NPT M	\$ 36.00
28896	PP, .250" O.D. Tubing x 3/8" O.D. Tubing	\$ 74.00
28381	PP, .250" O.D. Tubing x 1/2" NPT M	\$ 36.00
10482	PP, .375" O.D. Tubing x 1/4" NPT M	\$ 7.00
10804	PP, .5" O.D. Tubing x 1/2" NPT M	\$ 36.00
10895	PVC, .5" O.D. Tubing x 1/2" NPT M	\$ 36.00

Tubing Containment Kit		
Part No.	Description	Price
35899	Kit, Tubing Containment 1/4" & 3/8"	\$ 585.00
35618	COUPLING NUT, TUBING CONTAINMENT 1/4" & 3/8"	\$ 80.00

Tubing Connection System		
Part No.	Description	Price
77382	Tubing Connection Kit, 1/4"	\$ 14.00
77383	Tubing Connection Kit, 3/8"	\$ 14.00
77384	Tubing Connection Kit, 1/2"	\$ 14.00
77378	Tubing Connection Kit, 3X6MM	\$ 14.00
77379	Tubing Connection Kit, 6X8MM	\$ 14.00
77380	Tubing Connection Kit, 9X12MM	\$ 14.00
48378	Coupling Nut for Tubing Connection System	\$ 6.00

3FV with Tubing Connection System Adapter and Fittings		
Part No.	Description	Price
49146	3FV Adpt- Roytronic Fittings - PVDF/Aflas	\$ 64.00
49147	3FV Adpt- Roytronic Fittings - PVDF/PTFE	\$ 64.00
49148	3FV Adpt- Roytronic Fittings - PVC/Aflas	\$ 64.00

4FV for Tubing Connection System and ROYTRONIC® Fittings		
Part No.	Description	Price
48753	4FV ASM, PVC/AFLAS <150PSI	\$ 85.00
48754	4FV ASM, PVDF/AFLAS <150PSI	\$ 85.00
48755	4FV ASM, PVDF/PTFE <150PSI	\$ 85.00
48756	4FV ASM, PP/PTFE <150PSI	\$ 85.00
48798	4FV ASM, PVC/AFLAS <250PSI	\$ 85.00
48799	4FV ASM, PVDF/AFLAS <250PSI	\$ 85.00
48800	4FV ASM, PVDF/PTFE <250PSI	\$ 85.00
48801	4FV ASM, PP/PTFE <250PSI	\$ 85.00

4FV Fitting Assembly for ROYTRONIC® Fittings		
Part No.	Description	Price
49254	*4FV Fitting Assembly PVC/Polyprel	\$ 18.00
49255	*4FV Fitting Assembly PVDF/Polyprel	\$ 18.00
49256	*4FV Fitting Assembly PVDF/PTFE	\$ 18.00
49257	*4FV Fitting Assembly PP/PTFE	\$ 18.00

**Note: Includes coupling nut, 4FV fitting, and o-ring*

Adapters and Accessories - ROYTRONIC® and EXCEL®		
Part No.	Description	Price
50618	Coupling nut, PP, Tubing Containment Kit 1/4" & 3/8"	\$ 80.00
50627	Coupling Knob - Fluoride Satuator, Agitators, Tubing Shield	\$ 42.00
49216	Right Angle adapter for AUTOPRIME™ LE accessories	\$ 95.00

Cordsets and Connectors - ROYTRONIC® and EXCEL®		
Part No.	Description	Price
48414	Cordset, ROYTRONIC® 5 pin, 2M / 6.6 FT	\$ 70.00
49035	Cordset, ROYTRONIC® 6 pin, 2M / 6.6 FT	\$ 90.00
48488	Cordset, Adapter, Old 4 pin to ROYTRONIC® 5 pin	\$ 65.00
49253	Connector - ROYTRONIC® Low Level 3 Pin	\$ 85.00
48490	Connector - ROYTRONIC® 5 pin	\$ 55.00
50703	Cable ASM, Hall Effect - EXCEL AD9	\$ 160.00

Extension Cable Assemblies - ROYTRONIC® and EXCEL®		
Part No.	Description	Price
50503-6	5 Pin Extension Cable, 6 M / 19.7 FT	\$ 140.00
50503-15	5 Pin Extension Cable, 15 M / 49.2 FT	\$ 240.00
50684-6	6 Pin Extension Cable, 6 M / 19.7 FT	\$ 180.00
50684-15	6 Pin Extension Cable, 15 M / 49.2 FT	\$ 807.00

PARTS
by Number

Part Number	Description	UM	Price	Part Number	Description	UM	Price
10123	STRAINER, FOOT VALVE PP	EA	\$ 7.00	10681	HEAD, 3.0 PP	EA	\$ 363.00
10138	BALL, .500 CERAMIC	EA	\$ 9.00	10681-3	HEAD, 3.0 PP HV	EA	\$ 315.00
10139	SPRING, .48 X .038 X .88 SS	EA	\$ 1.46	10681-4	HEAD, 3.0 PP	EA	\$ 524.00
10140	SCREW, 10-24X 1.625 SS	EA	\$ 1.00	10746	BRACKET, PUMP HOLD-DOWN	EA	\$ 11.00
10141	TUBING, .500 OD X .062 VINYL - SEE NOTE *	FT	Consult	10764	VALVE ASM, INJ CK	EA	\$ 63.00
10141-500	TUBING, .500 OD X .062 VINYL, 500 FEET	EA	\$ 550.00	10784-1	FITTING, DRUM BUNG 2"	EA	\$ 21.00
10142	TUBING, .500 OD X .062 PE - SEE NOTE *	FT	Consult	10786-1	COUPLING, 1/2" NPT	EA	\$ 44.00
10142-10	TUBING, .500 OD X .062 PE, 10 FEET	EA	\$ 15.00	10789	PIPE, 1/2" SCHEDULE 80	EA	\$ 22.00
10142-500	TUBING, .500 OD X .062 PE, 500 FEET	EA	\$ 529.00	10792	VALVE SEAT, 1/2 TUBING	EA	\$ 25.00
10143	NUT, 10-24 HEX SS	EA	\$ 1.00	10792-1	VALVE SEAT, .375 X 1/4	EA	\$ 34.00
10153	VALVE ASM, FOOT LE-20/20S	EA	\$ 95.00	10793	VALVE HOUSING, 1/2	EA	\$ 28.00
10166	O-RING, 3.989 ID X .070 W BUNA N	EA	\$ 6.00	10793-1	VALVE HOUSING, .375 X	EA	\$ 39.00
10182-1	TERMINAL, WIRE #22-18	EA	\$ 1.00	10804	CONNECTOR ASM	EA	\$ 36.00
10206	VALVE SEAT, SUCTION PVC	EA	\$ 21.00	10828	VALVE, SOLENOID	EA	\$ 259.00
10207	RING, SEAL .375 VITON	EA	\$ 9.00	10833	CONNECTOR, 3/8 TUBE PP	EA	\$ 19.00
10228	RING, SEAL .500 VITON	EA	\$ 13.00	10834	ELBOW, 3/8 OD TUBE X 1/4	EA	\$ 13.00
10253	VALVE ASM, FOOT LE-26/26S	EA	\$ 95.00	10847-1	STRAINER, FLUORIDE SATURATOR	EA	\$ 87.00
10273	VALVE HOUSING, 1/2 TUBING PVC	EA	\$ 24.00	10884	KIT, SEAL RING VITON 1/2	EA	\$ 64.00
10292	VALVE SEAT, 3/8 OD TUB PVC	EA	\$ 16.00	10895	CONNECTOR ASM	EA	\$ 36.00
10293	VALVE HOUSING, 3/8 OD TUBING PVC	EA	\$ 20.00	10904	NUT, 1/2	EA	\$ 2.30
10294	FITTING, INJECTOR PVC	EA	\$ 18.00	10914	WIRE ASM	EA	\$ 4.30
10299	COUPLING NUT, PP 3/8	EA	\$ 6.00	10916	CABLE TIE	EA	\$ 0.94
10322	WEIGHT, SUCTION TUBING	EA	\$ 6.00	10928	KIT, SEAL RING VITON 3/8	EA	\$ 31.00
10338	BALL, .375 CERAMIC	EA	\$ 4.00	10930	KIT, SEAL RING TEFLON	EA	\$ 35.00
10340	SCREW, 10-24 X .75 PH SS	EA	\$ 2.00	10968	DISTRIBUTOR ASM, SATURATOR	EA	\$ 275.00
10342	TUBING, .375 OD X .062 PE - SEE NOTE *	FT	Consult	10973	SEAL, SHAFT	EA	\$ 8.00
10342-10	TUBING, .375 OD X .062 PE, 10 FEET	EA	\$ 13.00	10978	VALVE SEAT, PP	EA	\$ 25.00
10342-500	TUBING, .375 OD X .062 PE, 500 FEET	EA	\$ 498.00	12064	BRACKET, STROKE ADJ 4.2C	EA	\$ 119.00
10346	PLUG, PE (BLACK)	EA	\$ 1.00	21359	FRONT BEARING, LE-987	EA	\$ 24.00
10368-1	TERMINAL, WIRE #22-18	EA	\$ 1.00	25029	VALVE ASM, INJ CK	EA	\$ 75.00
10392	VALVE SEAT, 3/8 TUBING	EA	\$ 20.00	25030	VALVE ASM, DIS LE-94	EA	\$ 41.00
10393	VALVE HOUSING, 3/8	EA	\$ 22.00	25031	VALVE ASM, SUC LE-94	EA	\$ 37.00
10394	FITTING, INJECTOR 3/8 PP	EA	\$ 26.00	25032	VALVE ASM, FOOT LE-94	EA	\$ 64.00
10407	RING, SEAL .375 TEFLON	EA	\$ 6.00	25042	BALL, .500 SS	EA	\$ 5.00
10411	COUPLING NUT, PP 1/2	EA	\$ 8.00	25068	SLEEVE, SOLENOID	EA	\$ 70.00
10415	WASHER, CONICAL LOCK #10	EA	\$ 0.62	25070-1	TERMINAL, WIRE #22-18	EA	\$ 1.00
10422	RING, RETAINING	EA	\$ 1.00	25073	VALVE ASM, INJ CHK	EA	\$ 74.00
10436	PLUG, CAP .375 OD, PE (YELLOW)	EA	\$ 1.00	25074	VALVE ASM, DIS LE-95T	EA	\$ 50.00
10437	CAP, PLUG .516 OD PE	EA	\$ 1.00	25075	VALVE ASM, SUC LE-95T	EA	\$ 41.00
10444	BALL, .375 TEFLON	EA	\$ 5.00	25076	VALVE ASM, FOOT LE-95T	EA	\$ 64.00
10462	RING, RETAINING	EA	\$ 0.52	25079	INSERT, TUBING .375 PP	EA	\$ 4.00
10465	GROMMET, .25 X .56 NEOPRENE	EA	\$ 1.00	25104	VALVE ASM, INJ 75S 85S	EA	\$ 75.00
10469	TUBING VINYL, .375 OD X .062 - SEE NOTE *	FT	Consult	25105	VALVE ASM, DIS LE-75T	EA	\$ 45.00
10469-06	TUBING VINYL, .375 OD X .062, 6 FEET	EA	\$ 8.00	25106	VALVE SEAT, SUC PP 1/2	EA	\$ 31.00
10469-500	TUBING VINYL, .375 OD X .062, 500 FT	EA	\$ 498.00	25107	VALVE ASM, SUC LE-75T	EA	\$ 42.00
10492	VALVE SEAT, 1/2 TUBING PVC	EA	\$ 24.00	25108	FITTING, INJECTOR 1/2 PP	EA	\$ 29.00
10492-1	VALVE SEAT, 1/4 NPT	EA	\$ 25.00	25109	VALVE ASM, FOOT LE-75T	EA	\$ 65.00
10493	VALVE HOUSING, 1/2 TUBING PVC	EA	\$ 23.00	25121	GASKET, BUNA N	EA	\$ 1.00
10493-1	VALVE HOUSING, 1/4 NPT	EA	\$ 27.00	25125	CAP, SLEEVE .690D PE	EA	\$ 1.00
10501	VALVE ASM, INJ LE-91D/91DS/91S	EA	\$ 71.00	25127	SCREW, 10-24 X 4.5 RH SS	EA	\$ 6.00
10509	VALVE ASM, FOOT LE-92V	EA	\$ 64.00	25128	RING, SEAL .500 TEFLON	EA	\$ 15.00
10513	VALVE ASM, SUC LE-79/89	EA	\$ 36.00	25154	VALVE ASM, FOOT LE-25T, 35T	EA	\$ 95.00
10524	HEAD, 3.0 ACRYLIC	EA	\$ 277.00	25155	HEAD ASM, LE-25T	EA	\$ 340.00
10524-3	HEAD, 3.0 ACRYLIC	EA	\$ 288.00	25156	VALVE ASM, DIS LE-25T	EA	\$ 76.00
10525	HEAD, 3.0 PVC	EA	\$ 277.00	25157	VALVE ASM, SUC LE-25T	EA	\$ 59.00
10561	VALVE ASM, DIS LE-20	EA	\$ 55.00	25169	BOX, CORP STOP	EA	\$ 4.40
10562	VALVE ASM, SUC LE-20/21	EA	\$ 46.00	25173	VALVE HOUSING, .500 X 1/2 PP	EA	\$ 34.00
10563	VALVE ASM, DIS LE-26	EA	\$ 64.00	25178	VALVE ASM, INJ CK	EA	\$ 62.00
10564	VALVE ASM, SUC LE-26/26S	EA	\$ 46.00	25179	VALVE ASM, FOOT	EA	\$ 64.00
10568	HEAD ASM, LE-26	EA	\$ 432.00	25197	KIT, SEAL RING TEFLON	EA	\$ 44.00
10569	HEAD ASM, LE-20	EA	\$ 437.00	25199	VALVE HOUSING, UHMWPE	EA	\$ 60.00
10587	ELBOW, 3/8 TUBE X 1/4	EA	\$ 21.00	25201	VALVE ASM, DIS LE-82T	EA	\$ 48.00
10588	HEAD ASM, LE-20S	EA	\$ 545.00	25202	VALVE ASM, SUC LE-82T	EA	\$ 39.00
10589	HEAD ASM, LE-26S	EA	\$ 540.00	25203	VALVE ASM, INJ CHECK	EA	\$ 82.00
10590	AGITATOR, 34" SS 115V	EA	\$ 583.00	25204	VALVE ASM, FOOT LE-82T	EA	\$ 64.00
10592	AGITATOR, 34" N 115V	EA	\$ 665.00	25231	VALVE ASM, DIS LE-92T	EA	\$ 43.00
10598	SCREW, 10-24 X .625 PH SS	EA	\$ 1.00	25232	VALVE ASM, SUC LE-92T	EA	\$ 34.00
10601	BALL, .500 TEFLON	EA	\$ 6.50	25233	VALVE ASM, INJ CK LE-92T	EA	\$ 78.00
10626	VARISTOR ASM, 115V	EA	\$ 8.00	25234	VALVE ASM, FOOT LE-91T	EA	\$ 64.00
10627	VARISTOR ASM, 220-250V	EA	\$ 13.00	25268	VARISTOR ASM, 230V	EA	\$ 17.00
10659	BALL, .375 SS	EA	\$ 5.00	25273	VALVE ASM, INJ 71FS 81FS	EA	\$ 64.00

NOTE * - To purchase tubing in foot increments, contact your local distributor.

CONFIDENTIAL - FOR INTERNAL USE ONLY

All information and prices herein are subject to change without notice.

PARTS
by Number

Part Number	Description	UM	Price	Part Number	Description	UM	Price
25290	AGITATOR, 34" SS	EA	\$ 592.00	26015	VALVE ASM, FOOT LE-25P	EA	\$ 95.00
25292	AGITATOR, 34" N 220-240V	EA	\$ 683.00	26017	HEAD ASM, LE-24	EA	\$ 474.00
25299	BOX, OUTER 12 X 9 X 11	EA	\$ 11.00	26018	HEAD ASM, LE-34	EA	\$ 591.00
25301	INSERT, PACKING PSF	EA	\$ 17.00	26019	VALVE ASM, DIS LE-34	EA	\$ 85.00
25335	NOZZLE ASM, CORP STOP	EA	\$ 68.00	26020	VALVE ASM, SUC LE-24	EA	\$ 68.00
25344	BUSHING, .71ID X .75OD X .75 NY	EA	\$ 3.00	26021	VALVE ASM, FOOT LE-24/34	EA	\$ 95.00
25411	VALVE ASM, DIS LE-26T	EA	\$ 61.00	26024	VALVE, 1/2 NPT PVC	EA	\$ 55.00
25412	VALVE ASM, SUC LE-26T	EA	\$ 50.00	26025	BALL, .188 TEFLON	EA	\$ 2.00
25414	SPRING, .36 X .038 X .75	EA	\$ 4.00	26029	VALVE HOUSING, UHMWPE	EA	\$ 175.00
25423	SCREW, 10-24 X 5/8 SET	EA	\$ 0.83	26032	VALVE SEAT, 1/2 NPT PP	EA	\$ 50.00
25424	COLLAR, 1/2OD X 1/4ID	EA	\$ 6.00	26033	VALVE HOUSING, 1/2 NPT	EA	\$ 53.00
25452	LABEL, PUMP INSTRUCTION	EA	\$ 0.52	26035	VALVE ASM, AS/PR 1/4 NPT	EA	\$ 140.00
25492	VALVE ASM, FOOT LE-79/89	EA	\$ 84.00	26040	HEAD, 1.8 PP HV	EA	\$ 257.00
25550	HEAD, 0.9 ACRYLIC HV	EA	\$ 209.00	26049	SWITCH ASM, LL	EA	\$ 353.00
25558	SPRING, .42 X .24 X 1.0	EA	\$ 6.00	26050-1	HEAD, 0.9 PP HV	EA	\$ 329.00
25600	VALVE SEAT, FOOT PP	EA	\$ 29.00	26136	CLAMP RING, 3/8 OD TUBING	EA	\$ 2.00
25605	VALVE HOUSING, UHMWPE	EA	\$ 533.00	26163	HEAD ASM, LE-20HV	EA	\$ 525.00
25627	SCREW, 6-32 X 1.25 PH SS	EA	\$ 1.00	26293	CORD ASM, 115V B & C	EA	\$ 50.00
25628	NUT, 6-32 X HEX SS	EA	\$ 3.00	26297	CORD ASM, 220-250V DIN B	EA	\$ 29.00
25630	CAP, TUBE	EA	\$ 1.00	26323	BALL GUIDE, .500 DIA	EA	\$ 8.00
25631	NUT, RELIEF TUBING	EA	\$ 4.00	26350	TANK AND COVER ASM	EA	\$ 420.00
25636	TUBING PE, .250 X .062 - SEE NOTE *	FT	Consult	26350-1	TANK W/COVER, DRILL	EA	\$ 440.00
25636-06	TUBING PE, .250 X .062, 6 FEET	EA	\$ 8.00	26350-E1	TANK ASM, W/COVER HOLES	EA	\$ 1,132.00
25636-16	TUBING PE, .250 X .062, 16 FEET	EA	\$ 21.00	26383	VALVE ASM, DIS LE-95V	EA	\$ 39.00
25636-500	TUBING PE, .250 OD X .062, 500 FEET	EA	\$ 521.00	26475	HEAD ASM, LE-76PB	EA	\$ 432.00
25637	COVER, PUMP MOUNT 50 GAL	EA	\$ 127.00	26476	HEAD ASM, LE-86PB	EA	\$ 432.00
25643	CONNECTOR FEMALE, CABLE 4-PIN	EA	\$ 13.00	26490	SCREW, 6-32 THUMB NY	EA	\$ 2.00
25644	CONNECTOR MALE, CABLE 4-PIN	EA	\$ 25.00	26558	PLUG, 1/4 NPT PVC	EA	\$ 16.00
25648	PLUG, 3/4 - 16 PP YELLOW	EA	\$ 2.00	26576	MOTOR, AGITATOR 115V	EA	\$ 622.00
25649	VALVE SEAT, PP	EA	\$ 27.00	26577	SHAFT ASM, AGITATOR 35"	EA	\$ 199.00
25650	CONNECTOR, 1/2 NPT	EA	\$ 28.00	26579	FLANGE, AGITATOR MOUNTING	EA	\$ 72.00
25651	TUBING VINYL, .938 OD X .15 - SEE NOTE *	FT	Consult	26581	COUPLING, AGITATOR BRASS	EA	\$ 140.00
25651-3.5	TUBING VINYL, .938 OD X .15, 3.5 FT	EA	\$ 37.00	26637	COVER, TANK 50 GALLON	EA	\$ 143.00
25651-50	TUBING VINYL, .938 OD X .15, 50 FT	EA	\$ 518.00	26651	LIGHT ASM, SATURATOR	EA	\$ 63.00
25652	CLAMP, HOSE	EA	\$ 6.00	26710	VALVE ASM, INJ CK LE-25P/35P	EA	\$ 125.00
25659	HEAD ASM, LE-76/76HV	EA	\$ 400.00	26713	VALVE ASM, INJ CK LE-30/36	EA	\$ 90.00
25660	HEAD ASM, LE-86/86HV	EA	\$ 400.00	26716	VALVE ASM, INJ CK LE-24/34/24WK/34WK	EA	\$ 115.00
25661	VALVE ASM, DIS LE-76/86,	EA	\$ 63.00	26731	SWITCH ASM, LL 115V	EA	\$ 522.00
25662	VALVE ASM, SUC LE-76/86,	EA	\$ 53.00	26732	SWITCH ASM, LL 230V	EA	\$ 542.00
25663	VALVE ASM, INJ CK LE-20H	EA	\$ 90.00	26740	WINDOW & GASKET ASM	EA	\$ 42.00
25687	VALVE ASM, INJ CK	EA	\$ 64.00	26751	VALVE ASM, INJ CK LE-26	EA	\$ 90.00
25688	TANK, 50 GALLON	EA	\$ 746.00	26758	VALVE ASM, INJ CK LE-25T	EA	\$ 90.00
25718	HEAD, 6.0 ACRYLIC	EA	\$ 469.00	26763	HEAD ASM, LE-20PB	EA	\$ 558.00
25719	LIQUIFRAM, 6.0 FLUOROFILM (NON FABRIC)	EA	\$ 130.00	26779	CAP, PLUG PE BLACK 10 GAL TANK	EA	\$ 2.00
25825	FUSE, 4A RECTIFIER	EA	\$ 12.50	26817	CORD ASM, 220/250V UK B	EA	\$ 35.00
25869	VALVE BODY, AS/PR	EA	\$ 32.00	26839	VALVE SEAT, PVDF 3/8 TUB	EA	\$ 29.00
25870	VALVE BODY, AS/PR	EA	\$ 54.00	26840	VALVE HOUSING, PVDF 3/8	EA	\$ 25.00
25870-1	VALVE BODY, AS/PR	EA	\$ 74.00	26841	FITTING, INJECTOR	EA	\$ 30.00
25882	STROKE DIAL, BX1	EA	\$ 6.00	26847	VALVE BODY, 4FV 3/8 OD	EA	\$ 42.00
25889	KNOB, "A"	EA	\$ 19.00	26851	VALVE ASM, INJ CK LE-20/21	EA	\$ 75.00
25891	KNOB, B7, D7	EA	\$ 29.00	26856	VALVE BODY, 4FV 1/2 OD	EA	\$ 48.00
25905	HEAD, 6.0 PVC	EA	\$ 325.00	26856-1	VALVE BODY, 1/4 NPT	EA	\$ 139.00
25906	HEAD, 6.0 PP	EA	\$ 325.00	26893	EPU & SPACER ASM, "B"	EA	\$ 572.00
25906-3	HEAD, 6.0 PP HV	EA	\$ 375.00	26893CE	EPU & SPACER ASM, "B"	EA	\$ 572.00
25907	JACK ASM, W/FLAG	EA	\$ 25.00	26894	EPU & SPACER ASM, "B"	EA	\$ 572.00
25930	CAP, 4-PIN JACK	EA	\$ 2.10	26897	EPU & SPACER ASM, "B"	EA	\$ 572.00
25957	CORD CLAMP WITH NUT	EA	\$ 9.00	26897CE	EPU & SPACER ASM, "B"	EA	\$ 572.00
25957-1	CORD CLAMP	EA	\$ 7.00	26898	EPU & SPACER ASM, "B"	EA	\$ 616.00
25963	WASHER, NYLON	EA	\$ 0.62	26898CE	EPU & SPACER ASM, "B"	EA	\$ 477.00
25970	BOX, TANK 50 GALLON	EA	\$ 71.00	26900	TANK ASM, SATURATOR	EA	\$ 355.00
25976	HEAD ASM, LE-36	EA	\$ 551.00	26926	VALVE SEAT, 1/2 NPT SS	EA	\$ 182.00
25977	VALVE ASM, FOOT LE-36	EA	\$ 91.00	26928	VALVE HOUSING, 1/2 NPT SS	EA	\$ 264.00
25979	HEAD ASM, LE-30	EA	\$ 555.00	26950	VALVE ASM, INJ CK LE-92V	EA	\$ 90.00
25980	HEAD ASM, LE-35T	EA	\$ 413.00	26983	O-RING, .937 ID X .139 W	EA	\$ 5.00
25985	CAP ASM, TANK	EA	\$ 18.00	27034	SPRING & PAD ASM, D	EA	\$ 2.00
25990	CONNECTOR ASM, W/HDWR	EA	\$ 12.00	27039	CAP, PLUG 5.25OD PE	EA	\$ 5.00
26001	VALVE SEAT, 1/2 NPT PVC	EA	\$ 50.00	27043	VALVE ASM, AS/PR LE-72S	EA	\$ 140.00
26006	PULSE TRANSMITTER (A7, B7, C7, and P7)	EA	\$ 80.00	27048	VALVE ASM, AS/PR PVDF 3/8 OD	EA	\$ 90.00
26012	HEAD ASM, LE-35P	EA	\$ 428.00	27051	VALVE ASM, AS/PR PVDF 1/4 NPT	EA	\$ 170.00
26013	VALVE ASM, DIS LE-25P/35	EA	\$ 89.00	27052	VALVE ASM, DIS LE-25HV/76-86PB	EA	\$ 66.00
26014	VALVE ASM, SUC LE-35P	EA	\$ 76.00	27053	VALVE ASM, SUC LE-25HV/76PB	EA	\$ 71.00

NOTE * - To purchase tubing in foot increments, contact your local distributor.

CONFIDENTIAL - FOR INTERNAL USE ONLY

All information and prices herein are subject to change without notice.

PARTS
by Number

Part Number	Description	UM	Price	Part Number	Description	UM	Price
27080	VALVE ASM, INJ 25HV 75HV	EA	\$ 88.00	28026	VALVE ASM, FOOT 192/192S	EA	\$ 64.00
27081	HEAD ASM, LE-75HV	EA	\$ 400.00	28028	VALVE ASM, SUC 192/192S	EA	\$ 42.00
27082	HEAD ASM, LE-85HV	EA	\$ 400.00	28029	VALVE ASM, DIS LE-192	EA	\$ 48.00
27083	HEAD ASM, LE-25HV	EA	\$ 525.00	28033	HEAD ASM, LE-192S	EA	\$ 527.00
27097	STICKER, STROKE DIAL DX4	EA	\$ 6.00	28037	VALVE ASM, INJ CK LE-193/193S	EA	\$ 84.00
27142	TUBING PE, .500 OD X .062 - SEE NOTE *	FT	Consult	28038	VALVE ASM, FOOT LE-193/193S	EA	\$ 64.00
27142-500	TUBING PE, .500 OD X .062, 500 FEET	EA	\$ 592.00	28040	VALVE ASM, SUC LE-193/193S	EA	\$ 30.00
27161	COVER ASM, SATURATOR	EA	\$ 2,350.00	28041	VALVE ASM, DIS LE-193	EA	\$ 61.00
27166	TUBE, ANTI-RISE 3/8 PIPE	EA	\$ 77.00	28046	VALVE ASM, AS/PR PVDF	EA	\$ 100.00
27187	STUD, SPACING 4.2C	EA	\$ 2.00	28053	VALVE ASM, INJ CK LE-196/196S	EA	\$ 78.00
27214	HEAD, 1.8 PVDF	EA	\$ 130.00	28054	VALVE ASM, FOOT LE-196/196S	EA	\$ 64.00
27226	BOX, 20 1/4 X 20 1/4 X 31	EA	\$ 55.00	28056	VALVE ASM, SUC LE-196/196S	EA	\$ 29.00
27235	LABEL, CALIBRATION 35 GA	EA	Obsolete	28057	VALVE ASM, DIS LE-196	EA	\$ 35.00
27236	LABEL, CALIBRATION LITER	EA	\$ 5.20	28085	EPU & SPACER ASM, 0.5 115V	EA	\$ 452.00
27241	TRANSFORMER ASM,	EA	\$ 79.00	28275	VALVE ASM, INJ CK LE-151FS	EA	\$ 73.00
27243	SWITCH ASM, SATURATOR	EA	\$ 114.00	28276	VALVE ASM, FOOT LE-151FS	EA	\$ 64.00
27253	RING, RETAINING EXT 3/8	EA	\$ 1.00	28279	VALVE ASM, SUC LE-151FS	EA	\$ 51.00
27300	VALVE, 1/4 ANGLE PVC	EA	\$ 210.00	28291	SWITCH ASM, LEVEL-SATURATOR	EA	\$ 262.00
27301	BUSHING, .375 ID X .375	EA	\$ 8.00	28316	VALVE ASM, FOOT BARBED	EA	\$ 64.00
27325	TANK, 35 GALLON	EA	\$ 1,033.00	28368	CABLE ASM, A7, B7, C7	EA	\$ 49.00
27342	TUBING PE, .375 OD X .062 - SEE NOTE *	FT	Consult	28390	HEAD, 0.5 ACRYLIC	EA	\$ 189.00
27342-10	TUBING PE, .375 OD X .062, 10 FEET	EA	\$ 16.00	28391	HEAD, 0.5 PP	EA	\$ 276.00
27342-500	TUBING PE, .375 OD X .062, 500 FEET	EA	\$ 659.00	28410	LABEL, MODEL # FIELD	EA	\$ 3.00
27352	FLAPPER VALVE,	EA	\$ 7.00	28547	ARMATURE & SHAFT ASM, 3.5	EA	\$ 165.00
27394	HEAD, 3.0 316 SS	EA	\$ 1,552.00	28548	ARMATURE & SHAFT ASM, 4.2	EA	\$ 165.00
27397	CONNECTOR, MALE 35	EA	\$ 9.00	28578	VALVE HOUSING, 1/2 NPT	EA	\$ 190.00
27398-1	RETAINER TUBE, 35 GALLON TANK	EA	\$ 75.00	28636	TUBING PE, .250 OD X .062 - SEE NOTE *	FT	Consult
27400	TANK ASM, 35 GAL	EA	\$ 440.00	28636-500	TUBING PE, .250 OD X .062, 500 FEET	EA	\$ 554.00
27401	NIPPLE, 1/4 CLOSE PVC	EA	\$ 7.00	28663	FERRULE, 1/4" OD	EA	\$ 2.00
27417	SWITCH ASM, LL 35 GAL	EA	\$ 480.00	28664	VALVE SEAT, 1/4 TUBING	EA	\$ 19.00
27467	EPU & SPACER ASM,	EA	\$ 442.00	28665	VALVE HOUSING, 1/4	EA	\$ 20.00
27501	THERMOSTAT ASM, 4.2C	EA	\$ 21.00	28703	VALVE BODY, 4FV 1/4 OD	EA	\$ 31.00
27501CE	THERMOSTAT ASM, 4.2C	EA	\$ 21.00	28793	WIRE ASM,	EA	\$ 8.00
27511	HEAD, 1.8 UHMWPE SLURRY	EA	\$ 239.00	28804	CONNECTOR, TUBING	EA	\$ 39.00
27513	VALVE HOUSING, LE-79/89	EA	\$ 127.90	28850	SATURATOR ASM, WITH TANK	EA	\$ 2,750.00
27515	SPACER, 0.95I 4.2C	EA	\$ 136.00	28882	VALVE SEAT, 1/4 TUBING	EA	\$ 29.00
27516	SPACER, 1.8SI 4.2C	EA	\$ 131.00	28883	VALVE HOUSING, 1/4	EA	\$ 31.00
27517	SPACER, 3.0SI 4.2C	EA	\$ 76.00	28896	CONNECTOR ASM,	EA	\$ 74.00
27530	VALVE ASM, DIS LE-37	EA	\$ 284.00	28898	DOWEL, PLASTIC .250 OD X 1.75L	EA	\$ 2.08
27531	VALVE ASM, SUC LE-37	EA	\$ 202.00	28907	JACK ASM, W/STRAIGHT	EA	\$ 25.00
27534	VALVE ASM, INJ CK LE-27/37	EA	\$ 675.00	28925	HOUSING LESS WIRES	EA	\$ 126.00
27535	VALVE ASM, FOOT LE-27/37	EA	\$ 564.00	28970	HOUSING ASM, 115V B7 BE	EA	\$ 207.00
27551	SCREW, 10-24 X 1.25 RH ST	EA	\$ 0.83	28983	HOUSING ASM, 220-240V	EA	\$ 221.00
27586	SHIM, 3.5S 4.2C NY	EA	\$ 1.00	28998	KIT, DIS VLV 1/4 TUBE	EA	\$ 30.00
27591	AGITATOR, 27" SS 115V	EA	\$ 565.00	29033	CORD ASM, 115V A1X1, A7X1	EA	\$ 50.00
27600	VALVE ASM, INJ CK LE-91L/91DL	EA	\$ 93.00	29033CE	CORD ASM, 115V CE	EA	\$ 50.00
27601	VALVE ASM, DIS LE-91L/91DL/92L	EA	\$ 43.00	29042	CORD ASM, 230V DIN A1X3, A7X3	EA	\$ 34.32
27602	VALVE ASM, SZUC LE-91L/91DL/92L	EA	\$ 34.00	29042CE	CORD ASM, 220V DIN C7X3,	EA	\$ 38.00
27603	VALVE ASM, FOOT LE-91DL/92L	EA	\$ 64.00	29095	CAP, 1/4" COLLET	EA	\$ 5.00
27608	VALVE ASM, INJ CK LE-62/62S	EA	\$ 76.00	29190	SWITCH ASM, LEVEL A7 B7 D7	EA	\$ 107.00
27610	VALVE ASM, INJ CK LE-71	EA	\$ 77.00	29256	HOUSING, B1 SERIES	EA	\$ 178.00
27611	VALVE ASM, DIS LE-71L/72L	EA	\$ 38.00	29269	STROKE DIAL, AX7	EA	\$ 7.00
27612	VALVE ASM, SUC LE-71L/72L	EA	\$ 39.00	29272	EPU & SPACER ASM, 115V	EA	\$ 385.00
27613	VALVE ASM, FOOT LE-71L/72L	EA	\$ 64.00	29437	DISK, 0.9	EA	\$ 7.00
27615	VALVE ASM, INJ CK LE-72	EA	\$ 71.00	29442	DISK, 1.8	EA	\$ 8.00
27641	STUD ASM, 3.5 SI 4.2C	EA	\$ 9.00	29443	SEAL RING, COMPOSITE 3/8	EA	\$ 11.00
27641-1	STUD ASM, 3.0 SI 4.2C	EA	\$ 8.00	29445	DISK, 0.5	EA	\$ 8.00
27693	WIRE ASM, #18 GREEN	EA	\$ 4.47	29523	VALVE ASM, INJ CK, 75LS	EA	\$ 77.00
27701	CORD ASM, 220/250V SWISS	EA	\$ 32.00	29609	HEAD, 0.5 PVDF	EA	\$ 113.00
27719	CORD ASM, 115V A SERIES	EA	\$ 50.00	29611	HEAD, 0.9 PVDF	EA	\$ 161.00
27720	CORD ASM, 230V A SERIES	EA	\$ 50.00	29618	EPU 3.5 46 OHMS 3.0 B741	EA	\$ 797.00
27902	HEAD ASM, LE-36S	EA	\$ 659.00	29619	EPU 3.5 180 OHMS 3.0	EA	\$ 503.00
28001	VALVE ASM, INJ CK LE-190/190S	EA	\$ 62.00	29788	CORD ASM, 240V	EA	\$ 30.00
28002	VALVE ASM, FOOT LE-190/190S	EA	\$ 64.00	29797	WIRE ASM, J	EA	\$ 10.00
28004	VALVE ASM, SUC LE-190/190S	EA	\$ 30.00	29837	STICKER, STROKE J04 J05	EA	\$ 16.00
28005	VALVE ASM, DIS LE-190	EA	\$ 36.00	30099	CLAPPER ASM, A SERIES	EA	\$ 60.00
28013	VALVE ASM, INJ CK LE-191/191S	EA	\$ 60.00	30107	EPU ASM W/DISK, 0.5	EA	\$ 322.00
28014	VALVE ASM, FOOT LE-191/191S	EA	\$ 64.00	30108	EPU ASM W/DISK, 0.5	EA	\$ 259.00
28016	VALVE ASM, SUC LE-191/191S	EA	\$ 34.00	30154	EPU ASM, 3.0 82 OHMS	EA	\$ 322.00
28022	VALVE ASM, AS/PR PP 3/8	EA	\$ 100.00	30155	EPU, 3.0 330 OHMS	EA	\$ 234.00
28025	VALVE ASM, INJ CK 192/192S	EA	\$ 92.00	30240	EPU ASM W/DISK, 0.5	EA	\$ 322.00

NOTE * - To purchase tubing in foot increments, contact your local distributor.

CONFIDENTIAL - FOR INTERNAL USE ONLY

All information and prices herein are subject to change without notice.

PARTS
by Number

Part Number	Description	UM	Price	Part Number	Description	UM	Price
30241	EPU ASM W/DISK, 0.5	EA	\$ 333.00	31590	WASHER, 1.25 X .68 LDPE	EA	\$ 3.10
30242	EPU ASM W/DISK, 0.9	EA	\$ 322.00	31595	CORD ASM, J5XD	EA	\$ 50.00
30243	EPU ASM W/DISK, 0.9	EA	\$ 227.00	31617	COVER	EA	\$ 30.00
30295	KNOB ASM, 1/4 COLLET	EA	\$ 14.00	31682	VALVE ASM, AS/PR PVC 3/8	EA	\$ 140.00
30306	SCREW, SELF-TAP 10-10 X 1 SS	EA	\$ 1.00	31683	VALVE ASM, AS/PR	EA	\$ 73.00
30307	PLUG, PUSH IN	EA	\$ 1.00	31770	SHAFT ASM, SERIES C	EA	\$ 33.00
30348	SPRING, COATED	EA	\$ 36.00	31862	EPU, 3.0 82 OHMS	EA	\$ 226.00
30374	STICKER, STROKE DIAL AX6	EA	\$ 6.60	31890	KNOB ASM, "A" SERIES	EA	\$ 12.00
30375	VALVE HOUSING, PVC	EA	\$ 14.00	31891	KNOB ASM, "B" SERIES	EA	\$ 12.00
30383	VALVE SEAT, PVC	EA	\$ 13.00	31898	STROKE ADJ ASM, B SERIES	EA	\$ 89.00
30391	WASHER, 9/16 OD X 1/4 ID X .187	EA	\$ 1.00	31927	EPU W/STROKE ADJ, "B" 0.9 115V (D SHAFT)	EA	\$ 572.00
30414	BOX, "U" AND "P" PUMP	EA	\$ 9.00	31927CE	EPU W/STROKE ADJ, "B"	EA	\$ 572.00
30418	DIAL, STROKE PX2	EA	\$ 16.00	31928	EPU W/STROKE ADJ, "B" 0.9 230V (D SHAFT)	EA	\$ 1,108.00
30424	VALVE BODY, 4FV 1/4 OD PVC	EA	\$ 14.60	31928CE	EPU W/STROKE ADJ, "B"	EA	\$ 1,111.00
30425	VALVE BODY, 4FV 3/8 OD PVC	EA	\$ 22.00	31929	EPU W/STROKE ADJ, "B" 1.8 115V (D SHAFT)	EA	\$ 572.00
30426	VALVE BODY, 4FV 1/2 OD PVC GRAY	EA	\$ 24.00	31929CE	EPU W/STROKE ADJ, "B"	EA	\$ 494.00
30481	VALVE ASM, DIS LE-20PB/66PB/76PB/ 86PB	EA	\$ 73.00	31930	EPU W/STROKE ADJ, "B" 1.8 230V (D SHAFT)	EA	\$ 503.00
30530	EPU, 3.0 82 OHMS 120 V	EA	\$ 322.00	31931CE	EPU W/STROKE ADJ, "B"	EA	\$ 749.00
30531	EPU, 3.0 313 OHMS 240V	EA	\$ 340.00	31932	EPU W/STROKE ADJ, "B" 3.0S 230V (D SHAFT)	EA	\$ 533.00
30600	VALVE ASM, AS/PR LE-191SU	EA	\$ 140.00	31937	VALVE SEAT, 1/2 TUBING	EA	\$ 46.00
30643	LABEL COVER, CLEAR	EA	\$ 1.00	31938	VALVE HOUSING, 1/2" TUBING	EA	\$ 53.00
30709	KNOB, PUSH-ON	EA	\$ 8.00	32087	VALVE ASM, INJ CK	EA	\$ 103.00
30709B	KNOB ASM	EA	\$ 7.00	32088	VALVE ASM, INJ. CHECK	EA	\$ 89.00
30733	SUCTION CK VALVE, LE-987	EA	\$ 580.00	32115	CAP ASM, P/R PVDF	EA	\$ 42.00
30734	DISCHARGE CK VALVE, LE-987	EA	\$ 496.00	32158	EPU ASM, 120V, CX01,CX11	EA	\$ 937.00
30744	PLUG, CAP 1-14	EA	\$ 1.00	32158CE	EPU ASM, 120V C7 C9 CE	EA	\$ 1,236.00
30749	CORD, POWER 115V W/STR. RLF.	EA	\$ 50.00	32159	EPU ASM, 220/240V	EA	\$ 759.00
30754	CORD, POWER AUST. W/STR. RLF.	EA	\$ 31.20	32159CE	EPU ASM, 220-240V C7 C9	EA	\$ 678.00
30803	GASKET, NEOPRENE	EA	\$ 1.00	32171	CAP, THREADED RELIEF	EA	\$ 35.70
30840	VALVE SEAT, FOOT PVC	EA	\$ 26.00	32173	DIAPHRAGM	EA	\$ 7.00
30856	SCREW, 10-24 1.25L SS	EA	\$ 2.00	32175	O-RING, .234 ID X .139 W	EA	\$ 11.00
30860	COUPLING NUT, METRIC	EA	\$ 8.00	32176	O-RING, .676 ID X .070 W	EA	\$ 11.00
30896	CABLE ASM, CORP STOP 3/4	EA	\$ 32.00	32211	CAP	EA	\$ 2.00
30897	CABLE ASM, CORP STOP 1" STD	EA	\$ 50.00	32221	SPRING, .36 X .045 X .56	EA	\$ 1.00
30904-1	PACK JOINT, 3/4	EA	\$ 240.00	32239	EPU ASM, C761/C771	EA	\$ 1,172.00
30916	LIQUIFRAM, 0.5 FLUORFILM	EA	\$ 80.00	32240	EPU ASM, 220/240V, C76X/C77X	EA	\$ 2,157.00
30917	LIQUIFRAM, 0.9 FLUORFILM	EA	\$ 85.00	32247	STUD, SPACING	EA	\$ 5.00
30919	VALVE ASM, INJ CK LE-158	EA	\$ 90.00	32251	STROKE BRACKET ASM, SERIES "C"	EA	\$ 190.00
30921	VALVE ASM, FOOT LE-158	EA	\$ 64.00	32251CE	STROKE BRACKET ASM, 4.2C C SERIES	EA	\$ 182.00
30923	VALVE ASM, DIS LE-158	EA	\$ 37.00	32302	WASHER, FLAT	EA	\$ 0.80
30924	VALVE ASM, SUC LE-158	EA	\$ 32.00	32314	EPU ASM, 120V C781	EA	\$ 1,172.00
30926	CORD ASM, 115V	EA	\$ 50.00	32315	EPU ASM, 220/240V C78X	EA	\$ 932.00
30955	PULSER W/LABEL, DC 12A	EA	\$ 285.00	32329	EPU & SPACER ASM, C771	EA	\$ 1,172.00
30970	WASHER, PLUNGER ASM	EA	\$ 5.00	32330	EPU & SPACER ASM, C77X	EA	\$ 1,039.00
31031	INSERT, "A" SERIES	EA	\$ 2.00	32331	EPU & SPACER ASM, C781	EA	\$ 2,733.00
31032	INSERT, "B" SERIES	EA	\$ 4.00	32332	EPU W/SPACER ASM, C78X	EA	\$ 1,039.00
31040	VALVE ASM, INJ. CHECK LE-151P	EA	\$ 122.00	32352	O-RING, SPONGE	EA	\$ 3.60
31053	HEAD, 3.0 PVDF MOLDED	EA	\$ 172.00	32395	SCREW, SELF TAPPING	EA	\$ 2.00
31103	SEAL, 4.737 X .103 BUNA N	EA	\$ 2.10	32405	HOUSING ASM, C7X6	EA	\$ 230.00
31126	DIAL, STROKE PX4, PX5	EA	\$ 11.00	32428	POTENTIOMETER ASM	EA	\$ 87.30
31127	DIAL, STROKE P16X	EA	\$ 14.00	32448	POTENTIOMETER W/HDW, 1 MEG SPDT	EA	\$ 29.00
31131	EPU 3.0 330 OHMS P16X/P18X	EA	\$ 322.00	32465	STROKE DIAL, CX1	EA	\$ 6.00
31137	VALVE ASM, AS/PR	EA	\$ 140.00	32466	STROKE DIAL, CX2/CX6	EA	\$ 6.00
31255	VARISTOR ASM, 240V	EA	\$ 12.00	32467	STROKE DIAL, CX3	EA	\$ 7.00
31271	DIVIDER ASM, PD-4	EA	\$ 470.00	32468	STROKE DIAL, CX4	EA	\$ 38.00
31277	CONNECTOR ASM, 8 PIN	EA	\$ 32.00	32498	SCREW, 10-10 X 5/8 HEX HEAD	EA	\$ 0.50
31278	CABLE ASM, RFP	EA	\$ 42.00	32506	HEAD, 0.5 SS 316	EA	\$ 386.00
31290	KIT, METRIC TUBING	EA	\$ 38.00	32507	HEAD, 0.9 SS 316	EA	\$ 438.00
31332	VALVE HOUSING, BARBED PP	EA	\$ 25.00	32508	HEAD, 1.8 SS 316	EA	\$ 500.00
31419	LIQUIFRAM, 3.0 FLUORFILM (NON FABRIC)	EA	\$ 95.00	32509	HEAD, 3.0 SS 316	EA	\$ 417.00
31420	LIQUIFRAM, 1.8 FLUORFILM	EA	\$ 90.00	32514	VALVE ASM, INJ CHECK SS	EA	\$ 84.00
31429	COUPLING, (1) FOR RFP-07	EA	\$ 65.38	32515	VALVE ASM, CHECK 316 SS	EA	\$ 68.00
31437	GASKET, 1 1/2" RFP	EA	\$ 5.50	32516	HEAD ASM, LE-257	EA	\$ 546.00
31545	DIAL, STROKE P03	EA	\$ 8.00	32518	HEAD ASM, LE-277	EA	\$ 510.00
31561-1	VALVE SEAT, 1/4 NPT PVDF	EA	\$ 50.00	32532	EPU & SPACER ASM, "C" 0.9SI 120V	EA	\$ 881.00
31562	VALVE HOUSING, 1/2 TUBING PVDF	EA	\$ 41.00	32532CE	EPU & SPACER ASM, "C"	EA	\$ 937.00
31562-1	VALVE HOUSING, 1/4 NPT	EA	\$ 53.00	32534	EPU & SPACER ASM, "C" 1.8SI 120V	EA	\$ 937.00
31569	HEAD ASM, LE-30HV	EA	\$ 618.00	32534CE	EPU & SPACER ASM, "C"	EA	\$ 937.00
31571	CLAMP, CORD (PG-9)	EA	\$ 6.20	32535	EPU & SPACER ASM, "C" 1.8SI 230V	EA	\$ 770.00
31584	HEAD ASM, LE-35HV	EA	\$ 731.00	32536	EPU & SPACER ASM, "C" 3.0SI 120V	EA	\$ 937.00
31585	FUSE HOLDER	EA	\$ 5.00	32536CE	EPU & SPACER ASM, "C"	EA	\$ 937.00

NOTE * - To purchase tubing in foot increments, contact your local distributor.

CONFIDENTIAL - FOR INTERNAL USE ONLY

All information and prices herein are subject to change without notice.

PARTS
by Number

Part Number	Description	UM	Price	Part Number	Description	UM	Price
32537	EPU & SPACER ASM, "C" 3.0SI 230V	EA	\$ 937.00	35393	SPACER W/PLUG 5X5 0.9	EA	\$ 89.00
32578	PINION, THREAD ASM. 4.2C	EA	\$ 36.00	35394	SPACER W/PLUG 5X5 1.8	EA	\$ 78.00
32654	SHIM, .020 THICK 4.2	EA	\$ 7.00	35395	SPACER W/PLUG 5X5 3.0	EA	\$ 78.00
32698	EPU & SPACER ASM, 3.0 115V	EA	\$ 242.00	35398	HOUSING, 5 X 5 W/PG9	EA	\$ 120.00
32862	BUSHING, SHAFT AX1S	EA	\$ 10.40	35404	HOUSING, LESS WIRES	EA	\$ 213.00
32870	GEAR, 5.3 ECCENTRIC	EA	\$ 125.00	35420	VALVE SEAT, 1/2" NPT	EA	\$ 190.00
32879	SPRING, LG. 3.37 O.D.	EA	\$ 46.00	35585	VALVE HOUSING, 1/2" NPT	EA	\$ 111.00
32883	PIN, SPRING KNOB STOP	EA	\$ 6.00	35618	COUPLING NUT, TUBING CONTAINMENT 1/4" & 3/8"	EA	\$ 80.00
32899	SCREW, SET LIQ.SHAFT	EA	\$ 14.00	35643	CYLINDER, CALIBRATION 200 ML SEALED TOP	EA	\$ 160.00
33211	CONTROL PANEL ASM, B7/C7	EA	\$ 606.00	35644	CYLINDER, CALIBRATION 1000 ML SEALED TOP	EA	\$ 175.00
33211CE	CONTROL PANEL ASM, 120V	EA	\$ 574.00	35645	CYLINDER, CALIBRATION 200 ML EZ CLEAN	EA	\$ 122.00
33212	CONTROL PANEL ASM, 230V	EA	\$ 662.00	35708	PULSER, 115V AA1	EA	\$ 98.00
33212CE	CONTROL PANEL ASM, 230V	EA	\$ 574.00	35710	CYLINDER, CALIBRATION 1000mL EZ Clean	EA	\$ 169.00
33256	MAGNET, DIGIPULSE	EA	\$ 49.00	35743	SHAFT, SPEED ADJ	EA	\$ 4.00
33264	O-RING, .674 ID X .103 W POLYPREL	EA	\$ 2.00	35744	PIN, DUAL	EA	\$ 4.00
33270	FITTING, SMALL LOWER (PVDF)	EA	\$ 42.00	35837	SPACER, 0.9 W/O BOSSES	EA	\$ 76.00
33377	WASHER, DIGIPULSE	EA	\$ 2.00	35838	SPACER, 1.8 W/O BOSSES	EA	\$ 115.00
33480	VALVE ASM, FT LE-32, 325	EA	\$ 103.00	35839	SPACER, 3.0 W/O BOSSES	EA	\$ 109.00
33481	VALVE ASM, INJ CK LE-22/32/325	EA	\$ 102.00	35890	HOUSING, B9/C9	EA	\$ 254.00
33482	VALVE ASM, SUC LE-22/32/325	EA	\$ 114.00	35895CE	CONTROL PANEL ASM, B92/B93/B94 115V	EA	\$ 1,477.00
33510	SWITCH ASM, LL 35 GAL (230V)	EA	\$ 500.00	35949CE	HOUSING ASM, B9X1/C9X1	EA	\$ 223.00
33536	VALVE ASM, DIS LE-22/32	EA	\$ 75.00	35953CE	CONTROL PANEL ASM, B92/B93/B94 230V	EA	\$ 1,084.00
55787	REED SWITCH TRANSMITTER W/ FLYING LEADS	EA	Consult	35954CE	CONTROL PANEL ASM, B9X1 230V	EA	\$ 903.00
33738	CABLE ASM, 8 PIN/8WIRE	EA	\$ 43.00	35956CE	HOUSING ASM, B9X6/C9X6	EA	\$ 239.00
33796	CABLE ASM, 4 PIN/4 WIRE	EA	\$ 49.00	35960CE	CONTROL PANEL ASM, C901/C911 115V	EA	\$ 1,084.00
33814	CONTROL PANEL ASM, C701/C711	EA	\$ 536.00	35961CE	CONTROL PANEL ASM, C90X/C91X 230V	EA	\$ 1,084.00
33814CE	CONTROL PANEL ASM, CE-C701,C711	EA	\$ 989.00	35962CE	CONTROL PANEL ASM, C921 115 V	EA	\$ 1,084.00
33815	CONTROL PANEL ASM, C70X/C71X	EA	\$ 689.00	35963CE	CONTROL PANEL ASM, C92X 230V	EA	\$ 1,084.00
33816	CONTROL PANEL ASM, C721	EA	\$ 860.00	35964CE	CONTROL PANEL ASM, C931 115V	EA	\$ 1,084.00
33817	CONTROL PANEL ASM, C72X	EA	\$ 689.00	35965CE	CONTROL PANEL ASM, C93X 230V	EA	\$ 1,084.00
33817CE	CONTROL PANEL ASM, CE-C723,C725,C727	EA	\$ 989.00	35966CE	CONTROL PANEL ASM, C941 115V	EA	\$ 1,084.00
33818	CONTROL PANEL ASM, C731	EA	\$ 689.00	35967CE	CONTROL PANEL ASM, C94X 230V	EA	\$ 1,084.00
33819	CONTROL PANEL ASM, C73X	EA	\$ 689.00	36103	O-RING, .549 ID X .103 W POLYPREL	EA	\$ 3.00
33820	PANEL ASM, CONTROL	EA	\$ 750.00	36107	WASHER, CARTRIDGE VALVE	EA	\$ 1.00
33821	CONTROL PANEL ASM, C74X	EA	\$ 689.00	36128	HEAD, MOLDED 3.0 PVDF	EA	\$ 193.00
33821CE	CONTROL PANEL ASM, CE-C743, C745, C747	EA	\$ 989.00	36156	HEAD, MACHINED 0.5 ACRYLIC	EA	\$ 206.00
33822	CONTROL PANEL ASM, C781	EA	\$ 689.00	36157	HEAD, MACHINED 0.9	EA	\$ 159.00
33823	CONTROL PANEL ASM, C78X	EA	\$ 689.00	36159	HEAD, MACHINED 3.0	EA	\$ 238.00
33833	CABLE ASM, HALL EFFECT	EA	\$ 87.00	36178	STROKE DIAL, UX2	EA	\$ 6.00
34054	TANK, 15 GALLON WHITE	EA	\$ 200.00	36204	COUPLING, FOOT VALVE PP	EA	\$ 19.00
34074	GASKET, FOAM	EA	\$ 2.80	36213	CONTROL PANEL ASM, A161	EA	\$ 192.00
34088	COVER, UTILITY BOX	EA	\$ 17.70	36216	CONTROL PANEL ASM, A171	EA	\$ 192.00
34093	CONTROL PANEL ASM, B711	EA	\$ 606.00	36229	CONTROL PANEL ASM, B121, B131, B141	EA	\$ 406.00
34094	CONTROL PANEL ASM, B71X	EA	\$ 574.00	36230	CONTROL PANEL ASM, B1/C1X2	EA	\$ 385.00
34114	Plug, Audio 3.5 MM	EA	\$ 3.00	36231	CONTROL PANEL ASM, B1/C1XX	EA	\$ 352.00
34115	GASKET, PACKJOINT	EA	\$ 4.00	36234	CONTROL PANEL ASM, B111	EA	\$ 388.00
34116	RING, ANTI-FRICTION	EA	\$ 5.00	36237	CONTROL PANEL ASM, C101/C111	EA	\$ 418.00
34118	GASKET, PACK JOINT	EA	\$ 7.00	36240	CONTROL PANEL ASM, C121	EA	\$ 358.00
34493	CONTROLS, FLUORIDE	EA	\$ 1,800.00	36242	CONTROL PANEL ASM, C123-C127	EA	\$ 362.00
34497	O-RING, 0.25ID x 0.437OD	EA	\$ 1.00	36243	CONTROL PANEL ASM, C131	EA	\$ 418.00
34504	AGITATOR, 27" SS 230V	EA	\$ 581.00	36245	CONTROL PANEL ASM, C133-C137	EA	\$ 418.00
34566	FLOW CONTROLLER	EA	\$ 725.00	36246	CONTROL PANEL ASM, C141	EA	\$ 377.00
34610	VALVE BODY ASM, 1/2" TUBING	EA	\$ 114.00	36254	PULSER, FIXED	EA	\$ 116.00
34613	SEAL REPAIR KIT	EA	\$ 75.00	36255	PULSER, AA1/A1 REPLACEMENT	EA	\$ 116.00
34615	CAP ASM, ANTI SYPHON LARGE 4FV	EA	\$ 42.00	36256	PANEL W/NAMEPLATE, B1/C1	EA	\$ 36.00
34626	VALVE ASM, 4FV 1/2" BALL	EA	\$ 145.00	36260	CAP ASM, RELIEF	EA	\$ 42.00
34627	VALVE ASM, 4FV 1/2 BALL	EA	\$ 145.00	36280	CAP ASM, A/S	EA	\$ 42.00
34638	VALVE ASM, A-S/BLEED, 1/4	EA	\$ 165.00	36303	CARTRIDGE ASM, .281	EA	\$ 32.00
34639	VALVE ASM, A-S/BLEED,3/8	EA	\$ 165.00	36304	CARTRIDGE ASM, .281	EA	\$ 32.00
34640	VALVE ASM, A-S/BLEED,1/2	EA	\$ 165.00	36306	CARTRIDGE ASM, .375	EA	\$ 32.00
34641	VALVE ASM, A-S/BLEED, 1/4	EA	\$ 165.00	36307	CARTRIDGE ASM, .375	EA	\$ 22.00
34804	FITTING, LARGE LOWER PVDF	EA	\$ 77.00	36346	VALVE ASM, FOOT 1/4"	EA	\$ 64.00
34868	DISK, .490 OD X .20	EA	\$ 2.00	36348	VALVE ASM, SUC 1/4" PVDF	EA	\$ 58.00
34876	SCREW, BLEED	EA	\$ 6.50	36352	VALVE ASM, FOOT 3/8"	EA	\$ 64.00
34904	INSERT/PAD "U" AND "P"	EA	\$ 5.00	36354	VALVE ASM, SUC 3/8" PVDF	EA	\$ 58.00
35083	NAMEPLATE, P1	EA	\$ 12.00	36358	VALVE ASM, FOOT 1/2"	EA	\$ 64.00
35151	HEAD ASM, LE-86PBA	EA	\$ 432.00	36360	VALVE ASM, SUC 1/2" PVDF	EA	\$ 58.00
35184	LABEL SET, SILVER (BLANK)	EA	\$ 2.00	36364	VALVE ASM, FOOT 1/4" NPT	EA	\$ 64.00
35237	MOV/CAP ASM, AA1XX/AA7XX 230V	EA	\$ 20.00	36366	VALVE ASM, SUC 1/4" NPT	EA	\$ 58.00
35243	MOV/CAP ASM, AA1X1/AA7X1 120V	EA	\$ 27.00	36413	VALVE ASM, FOOT 1/4"	EA	\$ 65.00
35269	O-RING, 4.984 ID X .139	EA	\$ 10.00	36415	VALVE ASM, SUC 1/4" PVDF	EA	\$ 75.00

NOTE * - To purchase tubing in foot increments, contact your local distributor.

CONFIDENTIAL - FOR INTERNAL USE ONLY

All information and prices herein are subject to change without notice.

PARTS
by Number

Part Number	Description	UM	Price	Part Number	Description	UM	Price
36416	VALVE ASM, FOOT 3/8"	EA	\$ 64.00	38027	VALVE ASM, INJ 1/2" PVC	EA	\$ 72.00
36418	VALVE ASM, SUC 3/8" PVDF	EA	\$ 58.00	38028	VALVE ASM, INJ 1/4" NPT	EA	\$ 74.00
36419	VALVE ASM, FOOT 1/2" PVDF POLYPREL	EA	\$ 64.00	38029	VALVE ASM, INJ 4X6mm	EA	\$ 62.00
36421	VALVE ASM, SUC 1/2" PVDF	EA	\$ 39.00	38030	VALVE ASM, INJ 6X8mm	EA	\$ 89.00
36422	VALVE ASM, FOOT 1/4" NPT	EA	\$ 64.00	38031	VALVE ASM, FOOT 1/4"	EA	\$ 64.00
36424	VALVE ASM, SUC 1/4" NPT	EA	\$ 41.00	38032	VALVE ASM, FOOT 3/8"	EA	\$ 64.00
36499	VALVE ASM, FOOT 1/4" NPT	EA	\$ 64.00	38033	VALVE ASM, FOOT 1/2"	EA	\$ 64.00
36501	VALVE ASM, SUC 1/4" NPT	EA	\$ 52.00	38034	VALVE ASM, FOOT 1/4" NPT	EA	\$ 64.00
36502	VALVE ASM, FOOT 1/4" NPT	EA	\$ 64.00	38035	VALVE ASM, FOOT 1/4" NPT	EA	\$ 64.00
36504	VALVE ASM, SUC 1/4" NPT	EA	\$ 39.00	38036	VALVE ASM, FOOT 3X6mm	EA	\$ 64.00
36633	VALVE ASM, A/S BLEED 3X6MM PVDF	EA	\$ 67.00	38037	VALVE ASM, FOOT 6X8mm	EA	\$ 64.00
36635	VALVE ASM, A/S BLEED 6X8MM PVDF	EA	\$ 67.00	38053	VALVE BODY W/LABEL &	EA	\$ 37.00
55796	REED SWITCH TRANSMITTER W/ 3.5MM CONNECTOR	EA	\$ 93.60	38199	SCREW, SELF-TAP, HI-LO	EA	\$ 1.00
36810	DOWEL, PLASTIC .312 X .75	EA	\$ 1.00	38270	VALVE ASM, INJ	EA	\$ 144.00
36905	SPACER, FM-PRO	EA	\$ 18.00	38271	VALVE ASM, FOOT	EA	\$ 89.00
37113	FITTING WITH WASHER, 1/4" TUBING PVDF (CART)	EA	\$ 24.00	38377	HEAD KIT, 0.9 MOLDED	EA	\$ 106.00
37115	FITTING WITH WASHER, 3/8" TUBING PVDF (CART)	EA	\$ 24.00	38411	HOUSING ASM, P1 115V	EA	\$ 166.00
37117	FITTING WITH WASHER, 1/2" TUBING PVDF (CART)	EA	\$ 24.00	38413	HOUSING ASM, P1 230V DIN	EA	\$ 144.00
37119	FITTING WITH WASHER, 1/4" NPT PVDF (CART)	EA	\$ 24.00	38453	HOUSING ASM, P1X1 CE	EA	\$ 130.00
37144	SCREW KIT, HASTELLOY (4)	EA	\$ 127.00	38490	WASHER, FLAT #10 SS 316	EA	\$ 1.00
37203	CLAMP RING, 1/2" TUBING SST	EA	\$ 2.00	38561	HEAD, 0.9 MACHINED	EA	\$ 175.00
37221	VALVE BODY W/LABEL & WASHER, 3FV 1/4 PVDF	EA	\$ 48.00	38562	HEAD, 0.9 MACHINED PVC	EA	\$ 146.00
37229	VALVE BODY W/LABEL & WASHER, 3/8 PVDF	EA	\$ 48.00	38568	HEAD, 0.9 ACRYLIC HV	EA	\$ 189.00
37334	Liquid End Cartridge	EA	\$ 22.00	38568-1	HEAD, 0.9 ACRYLIC HV	EA	\$ 222.00
37335	Liquid End Cartridge	EA	\$ 26.00	38569	HEAD, 0.9 PP HV	EA	\$ 235.00
37337	Liquid End Cartridge	EA	\$ 22.00	38569-1	HEAD, 0.9 PP HV	EA	\$ 224.00
37338	Liquid End Cartridge	EA	\$ 26.00	38571	HEAD, 0.5 ACRYLIC HV	EA	\$ 262.00
37341	SPRING, COMPRESSION	EA	\$ 5.00	38571-1	HEAD, 0.5 ACRYLIC HV	EA	\$ 370.00
37349	KIT, REPLACEMENT, SPRING LOADED LIQUIPRO INJ CK	EA	\$ 13.00	38572	HEAD, 0.5 PP HV	EA	\$ 227.00
37351	FITTING, LIQUIPRO	EA	\$ 29.00	38572-1	HEAD, 0.5 PP HV	EA	\$ 338.00
37354	VALVE ASM, INJ 1/4" PVDF	EA	\$ 75.00	38578	HEAD, 0.5 MACHINED	EA	\$ 175.00
37356	VALVE ASM, INJ 3/8" PVDF	EA	\$ 71.00	38579	HEAD, 0.5 MACHINED PVC	EA	\$ 160.00
37358	VALVE ASM, INJ 1/2" PVDF	EA	\$ 75.00	38592	HEAD, 1.8 ACRYLIC HV	EA	\$ 196.00
37360	VALVE ASM, INJ 1/4" NPT	EA	\$ 71.00	38592-1	HEAD, 1.8 ACRYLIC HV	EA	\$ 231.00
37394	BOX, 15 1/8 X 10 5/8 X 10 13/16 BROWN PRINTED	EA	\$ 16.00	38593	HEAD, 1.8 PP HV	EA	\$ 207.00
37539	SPRING, CLEAR PVDF	EA	\$ 16.00	38593-1	HEAD, 1.8 PP HV	EA	\$ 284.00
37558	SPARE PARTS KIT, BP/AS &	EA	\$ 132.00	38595	HEAD, 1.8 ACRYLIC MACH	EA	\$ 202.00
37559	SPARE PARTS KIT, BP/AS &	EA	\$ 251.00	38596	HEAD, 1.8 PVC MACHINED	EA	\$ 206.00
37735	Use Kit 37824	EA	Consult	38856	ADAPTER, 6.0 LIQUIFRAM FORTRON	EA	\$ 183.00
37742	HEAD, 1.8 MACHINED PVC	EA	\$ 262.00	38886	STROKE BRACKET ADJ, SERIES AA	EA	\$ 11.00
37745	HEAD, 3.0 MACHINED PVC	EA	\$ 230.00	38887	GASKET, SERIES AA9	EA	\$ 23.00
37750	HEAD, 0.5 MOLDED PVC	EA	\$ 68.00	40573	O' RING 2-016 VITON	EA	\$ 7.00
37752	HEAD, 0.9 MOLDED PVC	EA	\$ 78.00	41227	SCREW, #8 X 1 3/8, HI-LO	EA	\$ 1.00
37754	HEAD, 1.8 MOLDED PVC	EA	\$ 130.00	41319	PULSE TRANSMITTER (AA7 ONLY)	EA	\$ 138.00
37756	HEAD, 3.0 MOLDED PVC	EA	\$ 145.00	48012	STROKE ADJ SHAFT ASM, SERIES AA	EA	\$ 25.00
37763	FITTING WITH WASHER,	EA	\$ 18.00	48013	CONTROL PANEL ASM, AA1X1 115V	EA	\$ 330.00
37765	FITTING WITH WASHER,	EA	\$ 18.00	48016	CONTROL PANEL ASM, AA7X1 115V	EA	\$ 530.00
37767	FITTING WITH WASHER,	EA	\$ 18.00	48018	CONTROL PANEL ASM, AA9X1 115V	EA	\$ 730.00
37769	FITTING WITH WASHER,	EA	\$ 18.00	48019	CONTROL PANEL ASM, AA9X2 230V	EA	\$ 1,606.00
37823	REPLACEMENT PULSER, P7/AA7 115V	EA	\$ 293.00	48025	EPU, AAX41/AAX51 115V	EA	\$ 452.00
37824	REPLACEMENT PULSER, P7/AA7 230V	EA	\$ 307.00	48027	EPU, AAX61 115V	EA	\$ 452.00
37844	VALVE ASM, FOOT 1/4" PVDF POLYPREL	EA	\$ 64.00	48029	EPU, AAX71/AAX81 115V	EA	\$ 452.00
37845	VALVE ASM, FOOT 3/8" PVDF POLYPREL	EA	\$ 64.00	48030	EPU, AAX71/AAX81 230V	EA	\$ 247.00
37846	VALVE ASM, SUC 1/4" PVDF POLYPREL	EA	\$ 37.00	48033	PTFE PLUNGER SEAL, LE-987	EA	\$ 106.00
37847	VALVE ASM, SUC 3/8" PVDF POLYPREL	EA	\$ 37.00	48034	EPU W/STROKE ADJ, AAX41/AAX51 115V	EA	\$ 452.00
37848	VALVE ASM, INJ 1/4" PVDF	EA	\$ 93.00	48035	EPU W/STROKE ADJ, AAX41/AAX51 230V	EA	\$ 693.00
37849	VALVE ASM, INJ 3/8" PVDF	EA	\$ 79.00	48036	EPU W/STROKE ADJ, AAX61 115V	EA	\$ 290.00
37855	VALVE ASM, INJ 1/2" PVDF	EA	\$ 62.00	48038	EPU W/STROKE ADJ, AAX71/AAX81 115V	EA	\$ 298.00
37856	CARTRIDGE ASM, .281 PVC/POLYPREL	EA	\$ 23.00	48043	VARISTOR, SERIES AA1X2 230V	EA	\$ 13.00
37857	CARTRIDGE ASM, .375 PVC/POLYPREL	EA	\$ 22.00	48158	SEAL, SHAFT, A/A+	EA	\$ 5.00
37858	Liquid End Cartridge	EA	\$ 22.00	48165	COVER, CLEAR, A	EA	\$ 12.00
37859	Liquid End Cartridge	EA	\$ 22.00	48166	O-RING, 2-049, BUNA-N	EA	\$ 2.00
37879	FOOT, SERIES AA	EA	\$ 20.00	48167	DISK, LE ADAPTER SC1	EA	\$ 8.00
37980	HEAD, 0.5 MOLDED PVDF(DEEP COR)	EA	\$ 102.00	48168	DISK, LE ADAPTER SC2	EA	\$ 9.00
38018	VALVE ASM, SUC 1/4" PVC	EA	\$ 35.00	48169	DISK, LE ADAPTER SC3	EA	\$ 7.00
38019	VALVE ASM, SUC 3/8" PVC	EA	\$ 35.00	48170	DISK, LE ADAPTER SC4	EA	\$ 7.00
38020	VALVE ASM, SUC 1/2" PVC	EA	\$ 35.00	48177	SHIM, EPU	EA	\$ 8.00
38021	VALVE ASM, SUC 1/4" NPT	EA	\$ 36.00	48177	SHIM, EPU, A/A+	EA	\$ 8.00
38022	VALVE ASM, SUC 1/4" NPT	EA	\$ 36.00	48186	LIQUIFRAM, SC1	EA	\$ 80.00
38025	VALVE ASM, INJ 1/4" PVC	EA	\$ 60.00	48187	LIQUIFRAM, SC2	EA	\$ 85.00
38026	VALVE ASM, INJ 3/8" PVC	EA	\$ 60.00	48188	LIQUIFRAM, SC3	EA	\$ 90.00

NOTE * - To purchase tubing in foot increments, contact your local distributor.

CONFIDENTIAL - FOR INTERNAL USE ONLY

All information and prices herein are subject to change without notice.

PARTS
by Number

Part Number	Description	UM	Price	Part Number	Description	UM	Price
48189	LIQUIFRAM, SC4	EA	\$ 95.00	48646	COUPLING KNOB, 4FV	EA	\$ 6.00
48214	HEAD, MACHINED, SC1 ACL	EA	\$ 152.00	48646	COUPLING KNOB, 4FV	EA	\$ 6.00
48215	Size 1 PVC machined head	EA	\$ 63.00	48656	STROKE KNOB ASSY	EA	\$ 20.00
48216	HEAD, MACHINED, SC1 PP	EA	\$ 186.00	48657	SPEED KNOB ASSY	EA	\$ 7.70
48218	HEAD, MACHINED, SC2 ACL	EA	\$ 158.00	48658	CONTROL PANEL ASSY, AO	EA	\$ 190.00
48219	HEAD, MACHINED, SC2 PVC	EA	\$ 122.00	48659	CONTROL PANEL ASSY, A1	EA	\$ 253.00
48220	HEAD, MACHINED, SC2 PP	EA	\$ 163.00	48660	CONTROL PANEL ASSY, A3	EA	\$ 309.00
48222	HEAD, MACHINED, SC3 ACL	EA	\$ 283.00	48661	CONTROL PANEL ASSY, A7	EA	\$ 526.00
48223	Size 2 PVC machined head	EA	\$ 130.00	48662	CONTROL PANEL ASSY, A8	EA	\$ 626.00
48224	HEAD, MACHINED, SC3 PP	EA	\$ 170.00	48663	FASTPRIME DISCHARGE CV	EA	\$ 40.00
48226	HEAD, MACHINED, SC4 ACL	EA	\$ 172.00	48664	FASTPRIME DISCHARGE CV	EA	\$ 44.00
48231	CORD, POWER USA 120V	EA	\$ 50.00	48665	FASTPRIME DISCHARGE CV	EA	\$ 64.00
48232	CORD, POWER USA 230V	EA	\$ 20.40	48666	FASTPRIME DISCHARGE CV	EA	\$ 43.00
48308	O-RING, 2-011 70D BUNA-N	EA	\$ 0.50	48667	FASTPRIME DISCHARGE CV	EA	\$ 49.00
48309	O-RING, 2-017 70D BUNA-N	EA	\$ 0.50	48668	FASTPRIME DISCHARGE CV	EA	\$ 75.00
48310	WASHER, M6 SMALL PLAIN	EA	\$ 0.50	48669	FASTPRIME DISCHARGE CV	EA	\$ 42.00
48313	RETAINING RING, 8MM	EA	\$ 5.00	48670	FASTPRIME DISCHARGE CV	EA	\$ 43.00
48327	SPRING, DIAPHRAGM SC1, A	EA	\$ 1.00	48671	FASTPRIME DISCHARGE CV	EA	\$ 38.00
48347	O-RING, 2-008 80D AFLAS	EA	\$ 1.00	48672	FASTPRIME DISCHARGE CV	EA	\$ 75.00
48349	O-RING, 2-111, 80DUR AFLAS	EA	\$ 3.00	48673	FASTPRIME DISCHARGE CV	EA	\$ 75.00
48363	HEAD, MOLDED FASTPRIME SC2	EA	\$ 82.00	48674	FASTPRIME DISCHARGE CV	EA	\$ 52.00
48364	HEAD, MOLDED FASTPRIME SC2	EA	\$ 88.00	48675	SUCTION CHECK VALVE, 718	EA	\$ 32.00
48366	HEAD, MOLDED FASTPRIME SC3	EA	\$ 130.00	48676	SUCTION CHECK VALVE, 728, 738,	EA	\$ 32.00
48367	HEAD, MOLDED FASTPRIME SC3	EA	\$ 143.00	48677	SUCTION CHECK VALVE, 812	EA	\$ 44.00
48369	HEAD, MOLDED FASTPRIME SC4	EA	\$ 134.00	48678	SUCTION CHECK VALVE, 813	EA	\$ 42.00
48370	HEAD, MOLDED FASTPRIME SC4	EA	\$ 129.00	48679	SUCTION CHECK VALVE	EA	\$ 75.00
48414	CORDSET, 5-PIN REVERSE KEY	EA	\$ 70.00	48680	SUCTION CHECK VALVE, 823, 833,	EA	\$ 75.00
48414	Cordset, Roytronic 5 pin	EA	\$ 70.00	48681	SUCTION CHECK VALVE	EA	\$ 55.00
48422	HEAD, AUTOPRIME, SC1 ACL	EA	\$ 302.00	48682	SUCTION CHECK VALVE, 915	EA	\$ 75.00
48423	HEAD, AUTOPRIME, SC1 PVC	EA	\$ 154.00	48683	SUCTION CHECK VALVE, 919	EA	\$ 75.00
48425	HEAD, AUTOPRIME, SC2 ACL	EA	\$ 191.00	48684	SUCTION CHECK VALVE	EA	\$ 44.00
48426	HEAD, AUTOPRIME, SC2 PVC	EA	\$ 185.00	48685	SUCTION CHECK VALVE, 925, 935	EA	\$ 75.00
48428	HEAD, AUTOPRIME, SC3 ACL	EA	\$ 260.00	48686	SUCTION CHECK VALVE, 929, 939,	EA	\$ 75.00
48429	HEAD, AUTOPRIME SC3 PVC	EA	\$ 175.00	48688	CONTROL PANEL ASSY, A11X	EA	\$ 418.00
48431	HEAD, AUTOPRIME, SC4 ACL	EA	\$ 281.00	48690	CONTROL PANEL ASSY, A71X	EA	\$ 409.00
48432	HEAD, AUTOPRIME, SC4 PVC	EA	\$ 167.00	48692	CARTRIDGE VALVE, 929, 939, 949	EA	\$ 22.00
48460	WIRE HARNESS, ROYTRONIC EPU	EA	\$ 31.00	48698	FASTPRIME CARTRIDGE VALVE, 929	EA	\$ 22.00
48471	HEAD, SC1, 316 SS	EA	\$ 417.00	48699	FASTPRIME VALVE, 8X2, 9X9	EA	\$ 36.00
48472	HEAD, SC2, 316 SS	EA	\$ 407.00	48700	FASTPRIME VALVE, 8X3	EA	\$ 33.00
48473	HEAD, SC3, 316 SS	EA	\$ 417.00	48701	FASTPRIME VALVE, 9X5	EA	\$ 38.00
48474	HEAD, SC4, 316 SS	EA	\$ 417.00	48702	LIQUID END HARDWARE, 9XX	EA	\$ 7.00
48488	ADAPTER, ROYTRONIC ACCESSORIES	EA	\$ 65.00	48703	LIQUID END HARDWARE, 7XX, 8XX	EA	\$ 7.00
48489	PULSE TRANSMITTER, ROYTRONIC	EA	\$ 104.00	48704	AUTOPRIME DISCHARGE CHECK	EA	\$ 75.00
48490	CONNECTOR, 5-PIN REVERSE KEY	EA	\$ 55.00	48705	AUTOPRIME DISCHARGE CHECK	EA	\$ 75.00
48528	STROKE DIAL, AX8	EA	\$ 9.00	48706	AUTOPRIME DISCHARGE CARTRIDGE	EA	\$ 42.00
48529	STROKE DIAL, AX9	EA	\$ 9.40	48707	AUTOPRIME DISCHARGE CARTRIDGE	EA	\$ 34.00
48534	PLUNGER ASM, SC1	EA	\$ 87.00	48708	AUTOPRIME SHUTTLE VALVE	EA	\$ 78.00
48535	PLUNGER ASM, SC2-4	EA	\$ 87.00	48709	AUTOPRIME SHUTTLE CARTRIDGE	EA	\$ 65.00
48543	CARTRIDGE VALVE, 920, 930, 940	EA	\$ 22.00	48718	FOOT VALVE, 910, X18	EA	\$ 64.00
48545	CARTRIDGE VALVE, 915, 813	EA	\$ 22.00	48719	FOOT VALVE, 919	EA	\$ 64.00
48546	CARTRIDGE VALVE, 925, 935, 945	EA	\$ 22.00	48720	FOOT VALVE, 812	EA	\$ 64.00
48549	FASTPRIME CARTRIDGE VALVE, 920	EA	\$ 22.00	48721	FOOT VALVE, 920, 930, 940	EA	\$ 64.00
48551	FASTPRIME CARTRIDGE VALVE, 915	EA	\$ 22.00	48722	FOOT VALVE, 929, 939, 949	EA	\$ 65.00
48552	FASTPRIME CARTRIDGE VALVE, 925	EA	\$ 22.00	48723	FOOT VALVE, 822, 832, 842	EA	\$ 65.00
48589	O-RING, PTFE, 2-113	EA	\$ 3.00	48724	FOOT VALVE, 813	EA	\$ 64.00
48590	O-RING, PTFE, 2-007, WHITE	EA	\$ 1.00	48725	FOOT VALVE, 823, 833, 843	EA	\$ 65.00
48591	O-RING, PTFE, 2-111	EA	\$ 3.00	48726	FOOT VALVE, 915	EA	\$ 65.00
48594	CONTROL PANEL AD2	EA	\$ 196.00	48727	FOOT VALVE, 925, 935, 945	EA	\$ 65.00
48595	CONTROL PANEL AD8	EA	\$ 213.00	48728	INJECTION VALVE, 9X0, XX8	EA	\$ 60.00
48596	CONTROL PANEL AD9	EA	\$ 223.00	48729	INJECTION VALVE, 9X5	EA	\$ 63.00
48599	HOUSING, AD	EA	\$ 276.00	48730	INJECTION VALVE, 9X9	EA	\$ 63.00
48600	STROKE BRACKET	EA	\$ 16.00	48731	INJECTION VALVE, 8X2	EA	\$ 60.00
48601	STROKE SHAFT, AD MALE	EA	\$ 33.00	48732	INJECTION VALVE, 8X3	EA	\$ 75.00
48602	STROKE SHAFT, AD FEMALE	EA	\$ 42.00	48743	HEAD, AUTOPRIME, 0.5 ACL	EA	\$ 191.00
48603	COVER, CLEAR AD	EA	\$ 17.00	48744	HEAD, AUTOPRIME, 0.9 ACL	EA	\$ 232.00
48617	FITTING, INJECTION VLV, PVC	EA	\$ 18.00	48745	HEAD, AUTOPRIME, 1.8 ACL	EA	\$ 184.00
48618	FITTING, INJECTION VLV, PVDF	EA	\$ 26.00	48748	HEAD, AUTOPRIME, 1.8 PVC	EA	\$ 259.00
48619	FITTING, INJECTION VLV, PP	EA	\$ 24.00	48750	O-RING, 015, FKM	EA	\$ 1.00
48622	4FV Bleed Nut - Roytronic	EA	\$ 6.00	48751	O-RING, 019, FKM	EA	\$ 1.00
48643	FITTING, 4FV, PVC	EA	\$ 18.00	48767	DISCHARGE CHECK VALVE, SS	EA	\$ 134.00
48644	FITTING, 4FV, PVDF	EA	\$ 24.00	48768	SUCTION CHECK VALVE, SS	EA	\$ 160.00

NOTE * - To purchase tubing in foot increments, contact your local distributor.

CONFIDENTIAL - FOR INTERNAL USE ONLY

All information and prices herein are subject to change without notice.

PARTS
by Number

Part Number	Description	UM	Price	Part Number	Description	UM	Price
48787	FITTING SGL BALL WITH O-RING	EA	\$ 16.00	49257	4FV Fitting Assembly PP/PTFE	EA	\$ 18.00
48788	FITTING SGL BALL WITH O-RING	EA	\$ 16.00	49282	CORP STOP, 3/4 NPT- "lead free"	EA	\$ 520.00
48789	FITTING SGL BALL WITH O-RING	EA	\$ 16.00	49283	CORP STOP, 1" NPT - "lead free"	EA	\$ 340.00
48790	FITTING SGL BALL WITH O-RING	EA	\$ 16.00	49284	CORP STOP, 1" Mueller- "lead free"	EA	\$ 340.00
48791	FITTING DBL BALL WITH O-RING	EA	\$ 18.00	49287	CORP STOP ASM, 3/4" - CA AB1953 mat'l req.	EA	\$ 350.00
48792	FITTING DBL BALL WITH O-RING	EA	\$ 18.00	49288	CORP STOP ASSY, 1" - CA AB1953 mat'l req.	EA	\$ 380.00
48793	FITTING DBL BALL WITH O-RING	EA	\$ 18.00	49289	CORP STOP & NOZZLE ASM - CA AB1953 mat'l req.	EA	\$ 580.00
48794	FITTING DBL BALL WITH O-RING	EA	\$ 18.00	49290	CORP STOP ASM, 1" - CA AB1953 mat'l req.	EA	\$ 340.00
48795	INJECTION VLV CARTRIDGE	EA	\$ 22.00	49296	4FV KIT PVC/POLYPREL 0.25" TUBE 250 PSI	EA	\$ 97.00
48796	INJECTION VLV CARTRIDGE	EA	\$ 18.00	49297	4FV KIT PVDF/POLYPREL 0.25" TUBE 250 PSI	EA	\$ 97.00
48805	STROKE DIAL, AX8	EA	\$ 9.40	49298	4FV KIT PVDF/PTFE 0.25" TUBE 250 PSI	EA	\$ 97.00
48823	WASHER,	EA	\$ 1.00	49299	4FV KIT PP/PTFE 0.25" TUBE 250 PSI	EA	\$ 99.00
48824	SCREW	EA	\$ 1.00	49300	4FV KIT PVC/POLYPREL 3/8" TUBE 150 PSI	EA	\$ 97.00
48842	NAMEPLATE, AD2	EA	\$ 39.00	49301	4FV KIT PVDF/POLYPREL 3/8" TUBE 150 PSI	EA	\$ 97.00
48843	NAMEPLATE, AD8	EA	\$ 50.00	49302	4FV KIT PVDF/PTFE 3/8" TUBE 150 PSI	EA	\$ 95.00
48844	NAMEPLATE, AD9	EA	\$ 44.00	49303	4FV KIT PP/PTFE 3/8" TUBE 150 PSI	EA	\$ 99.00
48848	Fastprime Valve xx8, 9x0	EA	\$ 28.00	49304	4FV KIT PVC/POLYPREL 1/2" TUBE 150 PSI	EA	\$ 100.00
48851	CORD, POWER USA 120V	EA	\$ 50.00	49305	4FV KIT PVDF/POLYPREL 1/2" TUBE 150 PSI	EA	\$ 100.00
48852	CORD, POWER USA 230V	EA	\$ 50.00	49306	4FV KIT PVDF/PTFE 1/2" TUBE 150 PSI	EA	\$ 100.00
48853	CORD, POWER DIN	EA	\$ 57.00	49307	4FV KIT PP/PTFE 1/2" TUBE 150 PSI	EA	\$ 102.00
48855	CORD, POWER BRITISH	EA	\$ 50.00	49308	STROKE DIAL	EA	\$ 10.00
48856	CORD, POWER AUST	EA	\$ 50.00	55789	REED SWITCH TRANSMITTER W/ 4 PIN CONNECT.	EA	\$ 104.00
48857	CORD, POWER SWISS	EA	\$ 45.00	49329	Head, machined SC2 HV Acrylic	EA	\$ 166.00
48859	CORD, POWER NO PLUG	EA	\$ 45.00	49331	Head, machined SC2 HV PP	EA	\$ 149.00
48861	O-RING	EA	\$ 3.00	49332	Head, machined SC2 HV Ported PP	EA	\$ 349.00
48870	Foot Valve,1/4" PVC/TFE	EA	\$ 56.00	49334	Head, machined SC3 HV Acrylic	EA	\$ 203.00
48873	Foot Valve,3/8" PVC/TFE	EA	\$ 64.00	49336	Head, machined SC3 HV PP	EA	\$ 149.00
48915	SC1 Head - replaces 48361	EA	\$ 128.00	49337	Head, machined SC3 HV Ported PP	EA	\$ 349.00
48966	O-RING,.176IDX.070W,PTFE-008	EA	\$ 2.00	49339	Head, machined SC4 HV Acrylic	EA	\$ 167.00
48997	SPRING, DIAPHRAGM	EA	\$ 5.00	49341	Head, machined SC4 HV PP	EA	\$ 149.00
48998	SPRING, DIAPHRAGM	EA	\$ 8.00	49342	Head, machined SC4 HV Ported PP	EA	\$ 349.00
48999	SPRING, DIAPHRAGM	EA	\$ 20.00	49395	Valve Assembly discharge	EA	\$ 40.00
49013	WIRE HARNESS, ROYTRONIC EXCEL	EA	\$ 70.00	49398	Valve Assembly injection	EA	\$ 80.00
49031	Housing ASM, 120 V	EA	\$ 309.00	49486	.5" & .25" Solvent PVC to Roytronic Tube Adapt	EA	\$ 23.00
49035	Cordset, Roytronic 6 pin	EA	\$ 90.00	50503-15	EXTENSION CABLE, 15 M / 49.2FT	EA	\$ 240.00
49088	VALVE ASM, SUC PVC/AFL/CER	EA	\$ 35.00	50503-6	EXTENSION CABLE, 6 M / 19.7FT	EA	\$ 140.00
49089	VALVE ASM, SUC PVDF/AFL/CER	EA	\$ 75.00	50508	50 piece 1/4" ferrule kit	EA	\$ 55.00
49090	VALVE ASM, SUC PVDF/AFL/CER	EA	\$ 38.00	50509	50 piece 3/8" ferrule kit	EA	\$ 110.00
49092	VALVE ASM, SUC PVDF/PTFE/CER	EA	\$ 75.00	50510	50 piece 1/2" ferrule kit	EA	\$ 110.00
49093	VALVE ASM, SUC PVDF/AFL/PTFE	EA	\$ 75.00	50529	HEAD, AUTOPRIME, 3.0 ACL	EA	\$ 313.00
49094	VALVE ASM, SUC PVDF/AFL/PTFE	EA	\$ 45.00	50530	HEAD, AUTOPRIME, 3.0 PVC	EA	\$ 191.00
49095	VALVE ASM, SUC PP/PTFE/CER	EA	\$ 75.00	50534	CONVERSION KIT, ROYTRONIC	EA	\$ 117.00
49097	CARTRIDGE SUB ASM, SPRING	EA	\$ 34.00	50535	CONVERSION KIT, ROYTRONIC	EA	\$ 117.00
49098	VALVE ASM, DIS SPRING	EA	\$ 75.00	50536	CONVERSION KIT, ROYTRONIC	EA	\$ 117.00
49099	Foot Valve,PVC/AFL/CER,358, 450, 458	EA	\$ 55.00	50537	CONVERSION KIT, ROYTRONIC	EA	\$ 117.00
49100	Foot Valve,PVC/AFL/CER, 3/468, 3/498, 460, 490	EA	\$ 64.00	50538	CONVERSION KIT, ROYTRONIC	EA	\$ 117.00
49101	Foot Valve,PVDF/AFL/CER, 352	EA	\$ 65.00	50539	CONVERSION KIT, ROYTRONIC	EA	\$ 117.00
49102	Foot Valve,PVDF/AFL/CER, 362, 392	EA	\$ 64.00	50540	CONVERSION KIT, ROYTRONIC	EA	\$ 117.00
49103	Foot Valve,PVDF/PTFE/CER, 353	EA	\$ 65.00	50541	CONVERSION KIT, ROYTRONIC	EA	\$ 117.00
49104	Foot Valve,PVDF/PTFE/CER, 363, 393	EA	\$ 65.00	50542	CONVERSION KIT, ROYTRONIC	EA	\$ 117.00
49105	Foot Valve,PVDF/AFL/PTFE, 459	EA	\$ 52.00	50627	Roy Coup Knob - Fluoride Satuator, Agitators, Tubing Shield	EA	\$ 42.00
49106	Foot Valve,PVDF/AFL/PTFE, 469, 499	EA	\$ 64.00	50657	Kit- Tube Adapter - PVDF w/Polyprel o-rings	EA	\$ 7.10
49107	Foot Valve,PP/PTFE/CER, 455	EA	\$ 65.00	50658	Kit -Tube Adapter-PVDF w/PTFE o-rings	EA	\$ 8.90
49108	Foot Valve,PP/PTFE/CER, 465, 495	EA	\$ 65.00	50659	Pole Piece Ass'y - Excel AD - 120 V	EA	\$ 366.00
49109	LIQUID END HARDWARE, 4XX, DXX	EA	\$ 7.00	50660	Pole Piece Ass'y - Excel AD - 240 V	EA	\$ 305.00
49137	O-RING,.362IDX.103W,PTFE	EA	\$ 3.00	50661	Pole Piece Ass'y-Excel AD-Universal Voltage	EA	\$ 350.00
49146	3FV Adpt- Roytronic Fittings - PVDF/Aflas	EA	\$ 64.00	50662	STROKE KNOB ASSY	EA	\$ 22.00
49147	3FV Adpt- Roytronic Fittings - PVDF/PTFE	EA	\$ 64.00	50663	PULSER ASM, AD2	EA	\$ 420.00
49148	3FV Adpt- Roytronic Fittings - PVC/Aflas	EA	\$ 64.00	50664	PULSER ASM, AD8	EA	\$ 450.00
49163	VALVE ASM, SUC	EA	\$ 75.00	50665	PULSER ASM, AD9	EA	\$ 555.00
49164	Foot Valve, 910A, 918A	EA	\$ 65.00	52396	BREAKER, VACUUM -Lead Free	EA	\$ 552.00
49165	Foot Valve, 920A, 928A	EA	\$ 64.00	54783	TUBING, UV KIT, 1/4"	EA	\$ 26.00
49166	VALVE ASM, SUC	EA	\$ 75.00	54784	TUBING, UV KIT, 3/8"	EA	\$ 50.00
49216	90 degree adapter	EA	\$ 95.00	54793	TUBING, UV KIT, 1/2"	EA	\$ 57.00
49244	Foot Valve, 822	EA	\$ 56.00	59235	FLOWMETER, RFP-075	EA	\$ 350.00
49246	Roytronic Low Level Switch Assembly	EA	\$ 240.00	59236	FLOWMETER, RFP-100	EA	\$ 540.00
49249	Switch, Dual Liquid Level (Excel only)	EA	\$ 280.00	59237	FLOWMETER, RFP-150	EA	\$ 960.00
49253	3 Pin Connector (4 Pin standard key)	EA	\$ 85.00	59238	FLOWMETER, RFP-200	EA	\$ 1,350.00
49254	4FV Fitting Assembly PVC/Polyprel	EA	\$ 18.00	59239	SENSOR ASM,RFP-075,100,150,200	EA	\$ 140.00
49255	4FV Fitting Assembly PVDF/Polyprel	EA	\$ 18.00	BV202139	BLEEDER PLUG	EA	\$ 38.00
49256	4FV Fitting Assembly PVDF/PTFE	EA	\$ 18.00				

NOTE * - To purchase tubing in foot increments, contact your local distributor.

CONFIDENTIAL - FOR INTERNAL USE ONLY

All information and prices herein are subject to change without notice.

PARTS
by Description

Part Number	Description	UM	Price	Part Number	Description	UM	Price
49486	.5" & .25" Solvent PVC to Roytronic Tube Adapt	EA	\$ 23.00	10916	CABLE TIE	EA	\$ 0.94
49253	3 Pin Connector (4 Pin standard key)	EA	\$ 85.00	32211	CAP	EA	\$ 2.00
49148	3FV Adpt- Roytronic Fittings - PVC/Aflas	EA	\$ 64.00	36280	CAP ASM, A/S	EA	\$ 42.00
49146	3FV Adpt- Roytronic Fittings - PVDF/Aflas	EA	\$ 64.00	34615	CAP ASM, ANTI SYPHON LARGE 4FV	EA	\$ 42.00
49147	3FV Adpt- Roytronic Fittings - PVDF/PTFE	EA	\$ 64.00	32115	CAP ASM, P/R PVDF	EA	\$ 42.00
48622	4FV Bleed Nut - Roytronic	EA	\$ 6.00	36260	CAP ASM, RELIEF	EA	\$ 42.00
49257	4FV Fitting Assembly PP/PTFE	EA	\$ 18.00	25985	CAP ASM, TANK	EA	\$ 18.00
49254	4FV Fitting Assembly PVC/Polyprel	EA	\$ 18.00	29095	CAP, 1/4" COLLET	EA	\$ 5.00
49255	4FV Fitting Assembly PVDF/Polyprel	EA	\$ 18.00	25930	CAP, 4-PIN JACK	EA	\$ 2.10
49256	4FV Fitting Assembly PVDF/PTFE	EA	\$ 18.00	10437	CAP, PLUG .516 OD PE	EA	\$ 1.00
49299	4FV KIT PP/PTFE 0.25" TUBE 250 PSI	EA	\$ 99.00	27039	CAP, PLUG 5.25OD PE	EA	\$ 5.00
49307	4FV KIT PP/PTFE 1/2" TUBE 150 PSI	EA	\$ 102.00	26779	CAP, PLUG PE BLACK 10 GAL TANK	EA	\$ 2.00
49303	4FV KIT PP/PTFE 3/8" TUBE 150 PSI	EA	\$ 99.00	25125	CAP, SLEEVE .69OD PE	EA	\$ 1.00
49296	4FV KIT PVC/POLYPREL 0.25" TUBE 250 PSI	EA	\$ 97.00	32171	CAP, THREADED RELIEF	EA	\$ 35.70
49304	4FV KIT PVC/POLYPREL 1/2" TUBE 150 PSI	EA	\$ 100.00	25630	CAP, TUBE	EA	\$ 1.00
49300	4FV KIT PVC/POLYPREL 3/8" TUBE 150 PSI	EA	\$ 97.00	36303	CARTRIDGE ASM, .281	EA	\$ 32.00
49297	4FV KIT PVDF/POLYPREL 0.25" TUBE 250 PSI	EA	\$ 97.00	36304	CARTRIDGE ASM, .281	EA	\$ 32.00
49305	4FV KIT PVDF/POLYPREL 1/2" TUBE 150 PSI	EA	\$ 100.00	37856	CARTRIDGE ASM, .281 PVC/POLYPREL	EA	\$ 23.00
49301	4FV KIT PVDF/POLYPREL 3/8" TUBE 150 PSI	EA	\$ 97.00	36306	CARTRIDGE ASM, .375	EA	\$ 32.00
49298	4FV KIT PVDF/PTFE 0.25" TUBE 250 PSI	EA	\$ 97.00	36307	CARTRIDGE ASM, .375	EA	\$ 22.00
49306	4FV KIT PVDF/PTFE 1/2" TUBE 150 PSI	EA	\$ 100.00	37857	CARTRIDGE ASM, .375 PVC/POLYPREL	EA	\$ 22.00
49302	4FV KIT PVDF/PTFE 3/8" TUBE 150 PSI	EA	\$ 95.00	49097	CARTRIDGE SUB ASM, SPRING	EA	\$ 34.00
50510	50 piece 1/2" ferrule kit	EA	\$ 110.00	48545	CARTRIDGE VALVE, 915, 813	EA	\$ 22.00
50508	50 piece 1/4" ferrule kit	EA	\$ 55.00	48543	CARTRIDGE VALVE, 920, 930, 940	EA	\$ 22.00
50509	50 piece 3/8" ferrule kit	EA	\$ 110.00	48546	CARTRIDGE VALVE, 925, 935, 945	EA	\$ 22.00
49216	90 degree adapter	EA	\$ 95.00	48692	CARTRIDGE VALVE, 929, 939, 949	EA	\$ 22.00
38856	ADAPTER, 6.0 LIQUIFRAM FORTRON	EA	\$ 183.00	37203	CLAMP RING, 1/2" TUBING SST	EA	\$ 2.00
48488	ADAPTER, ROYTRONIC ACCESSORIES	EA	\$ 65.00	26136	CLAMP RING, 3/8 OD TUBING	EA	\$ 2.00
27591	AGITATOR, 27" SS 115V	EA	\$ 565.00	31571	CLAMP, CORD (PG-9)	EA	\$ 6.20
34504	AGITATOR, 27" SS 230V	EA	\$ 581.00	25652	CLAMP, HOSE	EA	\$ 6.00
10592	AGITATOR, 34" N 115V	EA	\$ 665.00	30099	CLAPPER ASM, A SERIES	EA	\$ 60.00
25292	AGITATOR, 34" N 220-240V	EA	\$ 683.00	25424	COLLAR, 1/2OD X 1/4ID	EA	\$ 6.00
25290	AGITATOR, 34" SS	EA	\$ 592.00	10804	CONNECTOR ASM	EA	\$ 36.00
10590	AGITATOR, 34" SS 115V	EA	\$ 583.00	10895	CONNECTOR ASM	EA	\$ 36.00
28547	ARMATURE & SHAFT ASM, 3.5	EA	\$ 165.00	28896	CONNECTOR ASM,	EA	\$ 74.00
28548	ARMATURE & SHAFT ASM, 4.2	EA	\$ 165.00	31277	CONNECTOR ASM, 8 PIN	EA	\$ 32.00
48706	AUTOPRIME DISCHARGE CARTRIDGE	EA	\$ 42.00	25990	CONNECTOR ASM, W/HDWR	EA	\$ 12.00
48707	AUTOPRIME DISCHARGE CARTRIDGE	EA	\$ 34.00	25643	CONNECTOR FEMALE, CABLE 4-PIN	EA	\$ 13.00
48704	AUTOPRIME DISCHARGE CHECK	EA	\$ 75.00	25644	CONNECTOR MALE, CABLE 4-PIN	EA	\$ 25.00
48705	AUTOPRIME DISCHARGE CHECK	EA	\$ 75.00	25650	CONNECTOR, 1/2 NPT	EA	\$ 28.00
48709	AUTOPRIME SHUTTLE CARTRIDGE	EA	\$ 65.00	10833	CONNECTOR, 3/8 TUBE PP	EA	\$ 19.00
48708	AUTOPRIME SHUTTLE VALVE	EA	\$ 78.00	48490	CONNECTOR, 5-PIN REVERSE KEY	EA	\$ 55.00
26323	BALL GUIDE, .500 DIA	EA	\$ 8.00	27397	CONNECTOR, MALE 35	EA	\$ 9.00
26025	BALL, .188 TEFLON	EA	\$ 2.00	28804	CONNECTOR, TUBING	EA	\$ 39.00
10338	BALL, .375 CERAMIC	EA	\$ 4.00	48594	CONTROL PANEL AD2	EA	\$ 196.00
10659	BALL, .375 SS	EA	\$ 5.00	48595	CONTROL PANEL AD8	EA	\$ 213.00
10444	BALL, .375 TEFLON	EA	\$ 5.00	48596	CONTROL PANEL AD9	EA	\$ 223.00
10138	BALL, .500 CERAMIC	EA	\$ 9.00	33211CE	CONTROL PANEL ASM, 120V	EA	\$ 574.00
25042	BALL, .500 SS	EA	\$ 5.00	33212	CONTROL PANEL ASM, 230V	EA	\$ 662.00
10601	BALL, .500 TEFLON	EA	\$ 6.50	33212CE	CONTROL PANEL ASM, 230V	EA	\$ 574.00
BV202139	BLEEDER PLUG	EA	\$ 38.00	36213	CONTROL PANEL ASM, A161	EA	\$ 192.00
30414	BOX, "U" AND "P" PUMP	EA	\$ 9.00	36216	CONTROL PANEL ASM, A171	EA	\$ 192.00
37394	BOX, 15 1/8 X 10 5/8 X 10 13/16 BROWN PRINTED	EA	\$ 16.00	48013	CONTROL PANEL ASM, AA1X1 115V	EA	\$ 330.00
27226	BOX, 20 1/4 X 20 1/4 X 31	EA	\$ 55.00	48016	CONTROL PANEL ASM, AA7X1 115V	EA	\$ 530.00
25169	BOX, CORP STOP	EA	\$ 4.40	48018	CONTROL PANEL ASM, AA9X1 115V	EA	\$ 730.00
25299	BOX, OUTER 12 X 9 X 11	EA	\$ 11.00	48019	CONTROL PANEL ASM, AA9X2 230V	EA	\$ 1,606.00
25970	BOX, TANK 50 GALLON	EA	\$ 71.00	36230	CONTROL PANEL ASM, B1/C1X2	EA	\$ 385.00
10746	BRACKET, PUMP HOLD-DOWN	EA	\$ 11.00	36231	CONTROL PANEL ASM, B1/C1XX	EA	\$ 352.00
12064	BRACKET, STROKE ADJ 4.2C	EA	\$ 119.00	36234	CONTROL PANEL ASM, B111	EA	\$ 388.00
52396	BREAKER, VACUUM -Lead Free	EA	\$ 552.00	36229	CONTROL PANEL ASM, B121, B131, B141	EA	\$ 406.00
27301	BUSHING, .375 ID X .375	EA	\$ 8.00	33211	CONTROL PANEL ASM, B7/C7	EA	\$ 606.00
25344	BUSHING, .71ID X .75OD X .75 NY	EA	\$ 3.00	34093	CONTROL PANEL ASM, B711	EA	\$ 606.00
32862	BUSHING, SHAFT AX1S	EA	\$ 10.40	34094	CONTROL PANEL ASM, B71X	EA	\$ 574.00
33796	CABLE ASM, 4 PIN/4 WIRE	EA	\$ 49.00	35895CE	CONTROL PANEL ASM, B92/B93/B94 115V	EA	\$ 1,477.00
55789	REED SWITCH TRANSMITTER W/ 4 PIN CONNECT	EA	\$ 104.00	35953CE	CONTROL PANEL ASM, B92/B93/B94 230V	EA	\$ 1,084.00
33738	CABLE ASM, 8 PIN/8WIRE	EA	\$ 43.00	35954CE	CONTROL PANEL ASM, B9X1 230V	EA	\$ 903.00
28368	CABLE ASM, A7, B7, C7	EA	\$ 49.00	36237	CONTROL PANEL ASM, C101/C111	EA	\$ 418.00
30897	CABLE ASM, CORP STOP 1" STD	EA	\$ 50.00	36240	CONTROL PANEL ASM, C121	EA	\$ 358.00
30896	CABLE ASM, CORP STOP 3/4	EA	\$ 32.00	36242	CONTROL PANEL ASM, C123-C127	EA	\$ 362.00
33833	CABLE ASM, HALL EFFECT	EA	\$ 87.00	36243	CONTROL PANEL ASM, C131	EA	\$ 418.00
31278	CABLE ASM, RFP	EA	\$ 42.00	36245	CONTROL PANEL ASM, C133-C137	EA	\$ 418.00

NOTE * - To purchase tubing in foot increments, contact your local distributor.

CONFIDENTIAL - FOR INTERNAL USE ONLY

All information and prices herein are subject to change without notice.

PARTS
by Description

Part Number	Description	UM	Price	Part Number	Description	UM	Price
36246	CONTROL PANEL ASM, C141	EA	\$ 377.00	49284	CORP STOP, 1" Mueller- "lead free"	EA	\$ 340.00
33814	CONTROL PANEL ASM, C701/C711	EA	\$ 536.00	49283	CORP STOP, 1" NPT - "lead free"	EA	\$ 340.00
33815	CONTROL PANEL ASM, C70X/C71X	EA	\$ 689.00	49282	CORP STOP, 3/4 NPT- "lead free"	EA	\$ 520.00
33816	CONTROL PANEL ASM, C721	EA	\$ 860.00	48646	COUPLING KNOB, 4FV	EA	\$ 6.00
33817	CONTROL PANEL ASM, C72X	EA	\$ 689.00	48646	COUPLING KNOB, 4FV	EA	\$ 6.00
33818	CONTROL PANEL ASM, C731	EA	\$ 689.00	30860	COUPLING NUT, METRIC	EA	\$ 8.00
33819	CONTROL PANEL ASM, C73X	EA	\$ 689.00	10411	COUPLING NUT, PP 1/2	EA	\$ 8.00
33821	CONTROL PANEL ASM, C74X	EA	\$ 689.00	10299	COUPLING NUT, PP 3/8	EA	\$ 6.00
33822	CONTROL PANEL ASM, C781	EA	\$ 689.00	35618	COUPLING NUT, TUBING CONTAINMENT 1/4" & 3/8"	EA	\$ 80.00
33823	CONTROL PANEL ASM, C78X	EA	\$ 689.00	31429	COUPLING, (1) FOR RFP-07	EA	\$ 65.38
35960CE	CONTROL PANEL ASM, C901/C911 115V	EA	\$ 1,084.00	10786-1	COUPLING, 1/2" NPT	EA	\$ 44.00
35961CE	CONTROL PANEL ASM, C90X/C91X 230V	EA	\$ 1,084.00	26581	COUPLING, AGITATOR BRASS	EA	\$ 140.00
35962CE	CONTROL PANEL ASM, C921 115 V	EA	\$ 1,084.00	36204	COUPLING, FOOT VALVE PP	EA	\$ 19.00
35963CE	CONTROL PANEL ASM, C92X 230V	EA	\$ 1,084.00	31617	COVER	EA	\$ 30.00
35964CE	CONTROL PANEL ASM, C931 115V	EA	\$ 1,084.00	27161	COVER ASM, SATURATOR	EA	\$2,350.00
35965CE	CONTROL PANEL ASM, C93X 230V	EA	\$ 1,084.00	48603	COVER, CLEAR AD	EA	\$ 17.00
35966CE	CONTROL PANEL ASM, C941 115V	EA	\$ 1,084.00	48165	COVER, CLEAR, A	EA	\$ 12.00
35967CE	CONTROL PANEL ASM, C94X 230V	EA	\$ 1,084.00	25637	COVER, PUMP MOUNT 50 GAL	EA	\$ 127.00
33814CE	CONTROL PANEL ASM, CE-C701,C711	EA	\$ 989.00	26637	COVER, TANK 50 GALLON	EA	\$ 143.00
33817CE	CONTROL PANEL ASM, CE-C723,C725,C727	EA	\$ 989.00	34088	COVER, UTILITY BOX	EA	\$ 17.70
33821CE	CONTROL PANEL ASM, CE-C743, C745, C747	EA	\$ 989.00	35644	CYLINDER, CALIBRATION 1000 ML SEALED TOP	EA	\$ 175.00
48659	CONTROL PANEL ASSY, A1	EA	\$ 253.00	35710	CYLINDER, CALIBRATION 1000ml EZ Clean	EA	\$ 169.00
48688	CONTROL PANEL ASSY, A11X	EA	\$ 418.00	35645	CYLINDER, CALIBRATION 200 ML EZ CLEAN	EA	\$ 122.00
48660	CONTROL PANEL ASSY, A3	EA	\$ 309.00	35643	CYLINDER, CALIBRATION 200 ML SEALED TOP	EA	\$ 160.00
48661	CONTROL PANEL ASSY, A7	EA	\$ 526.00	31545	DIAL, STROKE P03	EA	\$ 8.00
48690	CONTROL PANEL ASSY, A71X	EA	\$ 409.00	31127	DIAL, STROKE P16X	EA	\$ 14.00
48662	CONTROL PANEL ASSY, A8	EA	\$ 626.00	30418	DIAL, STROKE PX2	EA	\$ 16.00
48658	CONTROL PANEL ASSY, AO	EA	\$ 190.00	31126	DIAL, STROKE PX4, PX5	EA	\$ 11.00
34493	CONTROLS, FLUORIDE	EA	\$ 1,800.00	32173	DIAPHRAGM	EA	\$ 7.00
50534	CONVERSION KIT, ROYTRONIC	EA	\$ 117.00	48767	DISCHARGE CHECK VALVE, SS	EA	\$ 134.00
50535	CONVERSION KIT, ROYTRONIC	EA	\$ 117.00	30734	DISCHARGE CK VALVE, LE-987	EA	\$ 496.00
50536	CONVERSION KIT, ROYTRONIC	EA	\$ 117.00	34868	DISK, .490 OD X .20	EA	\$ 2.00
50537	CONVERSION KIT, ROYTRONIC	EA	\$ 117.00	29445	DISK, 0.5	EA	\$ 8.00
50538	CONVERSION KIT, ROYTRONIC	EA	\$ 117.00	29437	DISK, 0.9	EA	\$ 7.00
50539	CONVERSION KIT, ROYTRONIC	EA	\$ 117.00	29442	DISK, 1.8	EA	\$ 8.00
50540	CONVERSION KIT, ROYTRONIC	EA	\$ 117.00	48167	DISK, LE ADAPTER SC1	EA	\$ 8.00
50541	CONVERSION KIT, ROYTRONIC	EA	\$ 117.00	48168	DISK, LE ADAPTER SC2	EA	\$ 9.00
50542	CONVERSION KIT, ROYTRONIC	EA	\$ 117.00	48169	DISK, LE ADAPTER SC3	EA	\$ 7.00
30926	CORD ASM, 115V	EA	\$ 50.00	48170	DISK, LE ADAPTER SC4	EA	\$ 7.00
27719	CORD ASM, 115V A SERIES	EA	\$ 50.00	10968	DISTRIBUTOR ASM, SATURATOR	EA	\$ 275.00
29033	CORD ASM, 115V A1X1, A7X1	EA	\$ 50.00	31271	DIVIDER ASM, PD-4	EA	\$ 470.00
26293	CORD ASM, 115V B & C	EA	\$ 50.00	28898	DOWEL, PLASTIC .250 OD X 1.75L	EA	\$ 2.08
29033CE	CORD ASM, 115V CE	EA	\$ 50.00	36810	DOWEL, PLASTIC .312 X .75	EA	\$ 1.00
27701	CORD ASM, 220/250V SWISS	EA	\$ 32.00	10834	ELBOW, 3/8 OD TUBE X 1/4	EA	\$ 13.00
26817	CORD ASM, 220/250V UK B	EA	\$ 35.00	10587	ELBOW, 3/8 TUBE X 1/4	EA	\$ 21.00
26297	CORD ASM, 220-250V DIN B	EA	\$ 29.00	27467	EPU & SPACER ASM,	EA	\$ 442.00
29042CE	CORD ASM, 220V DIN C7X3,	EA	\$ 38.00	26893	EPU & SPACER ASM, "B"	EA	\$ 572.00
27720	CORD ASM, 230V A SERIES	EA	\$ 50.00	26893CE	EPU & SPACER ASM, "B"	EA	\$ 572.00
29042	CORD ASM, 230V DIN A1X3, A7X3	EA	\$ 34.32	26894	EPU & SPACER ASM, "B"	EA	\$ 572.00
29788	CORD ASM, 240V	EA	\$ 30.00	26897	EPU & SPACER ASM, "B"	EA	\$ 572.00
31595	CORD ASM, J5XD	EA	\$ 50.00	26897CE	EPU & SPACER ASM, "B"	EA	\$ 572.00
25957-1	CORD CLAMP	EA	\$ 7.00	26898	EPU & SPACER ASM, "B"	EA	\$ 616.00
25957	CORD CLAMP WITH NUT	EA	\$ 9.00	26898CE	EPU & SPACER ASM, "B"	EA	\$ 477.00
30749	CORD, POWER 115V W/STR. RLF.	EA	\$ 50.00	32532CE	EPU & SPACER ASM, "C"	EA	\$ 937.00
48856	CORD, POWER AUST	EA	\$ 50.00	32534CE	EPU & SPACER ASM, "C"	EA	\$ 937.00
30754	CORD, POWER AUST. W/STR. RLF.	EA	\$ 31.20	32536CE	EPU & SPACER ASM, "C"	EA	\$ 937.00
48855	CORD, POWER BRITISH	EA	\$ 50.00	32532	EPU & SPACER ASM, "C" 0.9SI 120V	EA	\$ 881.00
48853	CORD, POWER DIN	EA	\$ 57.00	32534	EPU & SPACER ASM, "C" 1.8SI 120V	EA	\$ 937.00
48859	CORD, POWER NO PLUG	EA	\$ 45.00	32535	EPU & SPACER ASM, "C" 1.8SI 230V	EA	\$ 770.00
48857	CORD, POWER SWISS	EA	\$ 45.00	32536	EPU & SPACER ASM, "C" 3.0SI 120V	EA	\$ 937.00
48851	CORD, POWER USA 120V	EA	\$ 50.00	32537	EPU & SPACER ASM, "C" 3.0SI 230V	EA	\$ 937.00
48231	CORD, POWER USA 120V	EA	\$ 50.00	28085	EPU & SPACER ASM, 0.5 115V	EA	\$ 452.00
48852	CORD, POWER USA 230V	EA	\$ 50.00	29272	EPU & SPACER ASM, 115V	EA	\$ 385.00
48232	CORD, POWER USA 230V	EA	\$ 20.40	32698	EPU & SPACER ASM, 3.0 115V	EA	\$ 242.00
48414	CORDSET, 5-PIN REVERSE KEY	EA	\$ 70.00	32329	EPU & SPACER ASM, C771	EA	\$1,172.00
48414	Cordset, Roytronic 5 pin	EA	\$ 70.00	32330	EPU & SPACER ASM, C77X	EA	\$1,039.00
49035	Cordset, Roytronic 6 pin	EA	\$ 90.00	32331	EPU & SPACER ASM, C781	EA	\$2,733.00
49289	CORP STOP & NOZZLE ASM - CA AB1953 mat'l req.	EA	\$ 580.00	31131	EPU 3.0 330 OHMS P16X/P18X	EA	\$ 322.00
49290	CORP STOP ASM, 1" - CA AB1953 mat'l req.	EA	\$ 340.00	29619	EPU 3.5 180 OHMS 3.0	EA	\$ 503.00
49287	CORP STOP ASM, 3/4" - CA AB1953 mat'l req.	EA	\$ 350.00	29618	EPU 3.5 46 OHMS 3.0 B741	EA	\$ 797.00
49288	CORP STOP ASSY, 1" - CA AB1953 mat'l req.	EA	\$ 380.00	30107	EPU ASM W/DISK, 0.5	EA	\$ 322.00

NOTE * - To purchase tubing in foot increments, contact your local distributor.

CONFIDENTIAL - FOR INTERNAL USE ONLY

All information and prices herein are subject to change without notice.

PARTS
by Description

Part Number	Description	UM	Price	Part Number	Description	UM	Price
30108	EPU ASM W/DISK, 0.5	EA	\$ 259.00	37117	FITTING WITH WASHER, 1/2" TUBING PVDF (CART)	EA	\$ 24.00
30240	EPU ASM W/DISK, 0.5	EA	\$ 322.00	37119	FITTING WITH WASHER, 1/4" NPT PVDF (CART)	EA	\$ 24.00
30241	EPU ASM W/DISK, 0.5	EA	\$ 333.00	37113	FITTING WITH WASHER, 1/4" TUBING PVDF (CART)	EA	\$ 24.00
30242	EPU ASM W/DISK, 0.9	EA	\$ 322.00	37115	FITTING WITH WASHER, 3/8" TUBING PVDF (CART)	EA	\$ 24.00
30243	EPU ASM W/DISK, 0.9	EA	\$ 227.00	48643	FITTING, 4FV, PVC	EA	\$ 18.00
32158CE	EPU ASM, 120V C7 C9 CE	EA	\$ 1,236.00	48644	FITTING, 4FV, PVDF	EA	\$ 24.00
32314	EPU ASM, 120V C781	EA	\$ 1,172.00	10784-1	FITTING, DRUM BUNG 2"	EA	\$ 21.00
32158	EPU ASM, 120V, CX01,CX11	EA	\$ 937.00	48619	FITTING, INJECTION VLV, PP	EA	\$ 24.00
32159	EPU ASM, 220/240V	EA	\$ 759.00	48617	FITTING, INJECTION VLV, PVC	EA	\$ 18.00
32315	EPU ASM, 220/240V C78X	EA	\$ 932.00	48618	FITTING, INJECTION VLV, PVDF	EA	\$ 26.00
32240	EPU ASM, 220/240V, C76X/C77X	EA	\$ 2,157.00	26841	FITTING, INJECTOR	EA	\$ 30.00
32159CE	EPU ASM, 220-240V C7 C9	EA	\$ 678.00	25108	FITTING, INJECTOR 1/2 PP	EA	\$ 29.00
30154	EPU ASM, 3.0 82 OHMS	EA	\$ 322.00	10394	FITTING, INJECTOR 3/8 PP	EA	\$ 26.00
32239	EPU ASM, C761/C771	EA	\$ 1,172.00	10294	FITTING, INJECTOR PVC	EA	\$ 18.00
32332	EPU W/SPACER ASM, C78X	EA	\$ 1,039.00	34804	FITTING, LARGE LOWER PVDF	EA	\$ 77.00
31927CE	EPU W/STROKE ADJ, "B"	EA	\$ 572.00	37351	FITTING, LIQUIPRO	EA	\$ 29.00
31928CE	EPU W/STROKE ADJ, "B"	EA	\$ 1,111.00	33270	FITTING, SMALL LOWER (PVDF)	EA	\$ 42.00
31929CE	EPU W/STROKE ADJ, "B"	EA	\$ 494.00	26579	FLANGE, AGITATOR MOUNTING	EA	\$ 72.00
31931CE	EPU W/STROKE ADJ, "B"	EA	\$ 749.00	27352	FLAPPER VALVE,	EA	\$ 7.00
31927	EPU W/STROKE ADJ, "B" 0.9 115V (D SHAFT)	EA	\$ 572.00	34566	FLOW CONTROLLER	EA	\$ 725.00
31928	EPU W/STROKE ADJ, "B" 0.9 230V (D SHAFT)	EA	\$ 1,108.00	59235	FLOWMETER, RFP-075	EA	\$ 350.00
31929	EPU W/STROKE ADJ, "B" 1.8 115V (D SHAFT)	EA	\$ 572.00	59236	FLOWMETER, RFP-100	EA	\$ 540.00
31930	EPU W/STROKE ADJ, "B" 1.8 230V (D SHAFT)	EA	\$ 503.00	59237	FLOWMETER, RFP-150	EA	\$ 960.00
31932	EPU W/STROKE ADJ, "B" 3.0S 230V (D SHAFT)	EA	\$ 533.00	59238	FLOWMETER, RFP-200	EA	\$ 1,350.00
48034	EPU W/STROKE ADJ, AAX41/AAX51 115V	EA	\$ 452.00	48720	FOOT VALVE, 812	EA	\$ 64.00
48035	EPU W/STROKE ADJ, AAX41/AAX51 230V	EA	\$ 693.00	48724	FOOT VALVE, 813	EA	\$ 64.00
48036	EPU W/STROKE ADJ, AAX61 115V	EA	\$ 290.00	49244	Foot Valve, 822	EA	\$ 56.00
48038	EPU W/STROKE ADJ, AAX71/AAX81 115V	EA	\$ 298.00	48723	FOOT VALVE, 822, 832, 842	EA	\$ 65.00
30155	EPU, 3.0 330 OHMS	EA	\$ 234.00	48725	FOOT VALVE, 823, 833, 843	EA	\$ 65.00
30531	EPU, 3.0 313 OHMS 240V	EA	\$ 340.00	48718	FOOT VALVE, 910, X18	EA	\$ 64.00
31862	EPU, 3.0 82 OHMS	EA	\$ 226.00	49164	Foot Valve, 910A, 918A	EA	\$ 65.00
30530	EPU, 3.0 82 OHMS 120 V	EA	\$ 322.00	48726	FOOT VALVE, 915	EA	\$ 65.00
48025	EPU, AAX41/AAX51 115V	EA	\$ 452.00	48719	FOOT VALVE, 919	EA	\$ 64.00
48027	EPU, AAX61 115V	EA	\$ 452.00	48721	FOOT VALVE, 920, 930, 940	EA	\$ 64.00
48029	EPU, AAX71/AAX81 115V	EA	\$ 452.00	49165	Foot Valve, 920A, 928A	EA	\$ 64.00
48030	EPU, AAX71/AAX81 230V	EA	\$ 247.00	48727	FOOT VALVE, 925, 935, 945	EA	\$ 65.00
50503-15	EXTENSION CABLE, 15 M / 49.2FT	EA	\$ 240.00	48722	FOOT VALVE, 929, 939, 949	EA	\$ 65.00
50503-6	EXTENSION CABLE, 6 M / 19.7FT	EA	\$ 140.00	48870	Foot Valve, 1/4" PVC/TFE	EA	\$ 56.00
48551	FASTPRIME CARTRIDGE VALVE, 915	EA	\$ 22.00	48873	Foot Valve, 3/8" PVC/TFE	EA	\$ 64.00
48549	FASTPRIME CARTRIDGE VALVE, 920	EA	\$ 22.00	49107	Foot Valve, PP/PTFE/CER, 455	EA	\$ 65.00
48552	FASTPRIME CARTRIDGE VALVE, 925	EA	\$ 22.00	49108	Foot Valve, PP/PTFE/CER, 465, 495	EA	\$ 65.00
48698	FASTPRIME CARTRIDGE VALVE, 929	EA	\$ 22.00	49100	Foot Valve, PVC/AFL/CER, 3/468, 3/498, 460, 490	EA	\$ 64.00
48663	FASTPRIME DISCHARGE CV	EA	\$ 40.00	49099	Foot Valve, PVC/AFL/CER, 358, 450, 458	EA	\$ 55.00
48664	FASTPRIME DISCHARGE CV	EA	\$ 44.00	49101	Foot Valve, PVDF/AFL/CER, 352	EA	\$ 65.00
48665	FASTPRIME DISCHARGE CV	EA	\$ 64.00	49102	Foot Valve, PVDF/AFL/CER, 362, 392	EA	\$ 64.00
48666	FASTPRIME DISCHARGE CV	EA	\$ 43.00	49105	Foot Valve, PVDF/AFL/PTFE, 459	EA	\$ 52.00
48667	FASTPRIME DISCHARGE CV	EA	\$ 49.00	49106	Foot Valve, PVDF/AFL/PTFE, 469, 499	EA	\$ 64.00
48668	FASTPRIME DISCHARGE CV	EA	\$ 75.00	49103	Foot Valve, PVDF/PTFE/CER, 353	EA	\$ 65.00
48669	FASTPRIME DISCHARGE CV	EA	\$ 42.00	49104	Foot Valve, PVDF/PTFE/CER, 363, 393	EA	\$ 65.00
48670	FASTPRIME DISCHARGE CV	EA	\$ 43.00	37879	FOOT, SERIES AA	EA	\$ 20.00
48671	FASTPRIME DISCHARGE CV	EA	\$ 38.00	21359	FRONT BEARING, LE-987	EA	\$ 24.00
48672	FASTPRIME DISCHARGE CV	EA	\$ 75.00	31585	FUSE HOLDER	EA	\$ 5.00
48673	FASTPRIME DISCHARGE CV	EA	\$ 75.00	25825	FUSE, 4A RECTIFIER	EA	\$ 12.50
48674	FASTPRIME DISCHARGE CV	EA	\$ 52.00	31437	GASKET, 1 1/2" RFP	EA	\$ 5.50
48848	Fastprime Valve xx8, 9x0	EA	\$ 28.00	25121	GASKET, BUNA N	EA	\$ 1.00
48699	FASTPRIME VALVE, 8X2, 9X9	EA	\$ 36.00	34074	GASKET, FOAM	EA	\$ 2.80
48700	FASTPRIME VALVE, 8X3	EA	\$ 33.00	30803	GASKET, NEOPRENE	EA	\$ 1.00
48701	FASTPRIME VALVE, 9X5	EA	\$ 38.00	34118	GASKET, PACK JOINT	EA	\$ 7.00
28663	FERRULE, 1/4" OD	EA	\$ 2.00	34115	GASKET, PACKJOINT	EA	\$ 4.00
48791	FITTING DBL BALL WITH O-RING	EA	\$ 18.00	38887	GASKET, SERIES AA9	EA	\$ 23.00
48792	FITTING DBL BALL WITH O-RING	EA	\$ 18.00	32870	GEAR, 5.3 ECCENTRIC	EA	\$ 125.00
48793	FITTING DBL BALL WITH O-RING	EA	\$ 18.00	10465	GROMMET, .25 X .56 NEOPRENE	EA	\$ 1.00
48794	FITTING DBL BALL WITH O-RING	EA	\$ 18.00	28033	HEAD ASM, LE-192S	EA	\$ 527.00
48787	FITTING SGL BALL WITH O-RING	EA	\$ 16.00	10569	HEAD ASM, LE-20	EA	\$ 437.00
48788	FITTING SGL BALL WITH O-RING	EA	\$ 16.00	26163	HEAD ASM, LE-20HV	EA	\$ 525.00
48789	FITTING SGL BALL WITH O-RING	EA	\$ 16.00	26763	HEAD ASM, LE-20PB	EA	\$ 558.00
48790	FITTING SGL BALL WITH O-RING	EA	\$ 16.00	10588	HEAD ASM, LE-20S	EA	\$ 545.00
37763	FITTING WITH WASHER,	EA	\$ 18.00	26017	HEAD ASM, LE-24	EA	\$ 474.00
37765	FITTING WITH WASHER,	EA	\$ 18.00	32516	HEAD ASM, LE-257	EA	\$ 546.00
37767	FITTING WITH WASHER,	EA	\$ 18.00	27083	HEAD ASM, LE-25HV	EA	\$ 525.00
37769	FITTING WITH WASHER,	EA	\$ 18.00	25155	HEAD ASM, LE-25T	EA	\$ 340.00

NOTE * - To purchase tubing in foot increments, contact your local distributor.

CONFIDENTIAL - FOR INTERNAL USE ONLY

All information and prices herein are subject to change without notice.

PARTS
by Description

Part Number	Description	UM	Price	Part Number	Description	UM	Price
10568	HEAD ASM, LE-26	EA	\$ 432.00	48744	HEAD, AUTOPRIME, 0.9 ACL	EA	\$ 232.00
10589	HEAD ASM, LE-26S	EA	\$ 540.00	48745	HEAD, AUTOPRIME, 1.8 ACL	EA	\$ 184.00
32518	HEAD ASM, LE-277	EA	\$ 510.00	48748	HEAD, AUTOPRIME, 1.8 PVC	EA	\$ 259.00
25979	HEAD ASM, LE-30	EA	\$ 555.00	50529	HEAD, AUTOPRIME, 3.0 ACL	EA	\$ 313.00
31569	HEAD ASM, LE-30HV	EA	\$ 618.00	50530	HEAD, AUTOPRIME, 3.0 PVC	EA	\$ 191.00
26018	HEAD ASM, LE-34	EA	\$ 591.00	48422	HEAD, AUTOPRIME, SC1 ACL	EA	\$ 302.00
31584	HEAD ASM, LE-35HV	EA	\$ 731.00	48423	HEAD, AUTOPRIME, SC1 PVC	EA	\$ 154.00
26012	HEAD ASM, LE-35P	EA	\$ 428.00	48425	HEAD, AUTOPRIME, SC2 ACL	EA	\$ 191.00
25980	HEAD ASM, LE-35T	EA	\$ 413.00	48426	HEAD, AUTOPRIME, SC2 PVC	EA	\$ 185.00
25976	HEAD ASM, LE-36	EA	\$ 551.00	48428	HEAD, AUTOPRIME, SC3 ACL	EA	\$ 260.00
27902	HEAD ASM, LE-36S	EA	\$ 659.00	48431	HEAD, AUTOPRIME, SC4 ACL	EA	\$ 281.00
27081	HEAD ASM, LE-75HV	EA	\$ 400.00	48432	HEAD, AUTOPRIME, SC4 PVC	EA	\$ 167.00
25659	HEAD ASM, LE-76/76HV	EA	\$ 400.00	36156	HEAD, MACHINED 0.5 ACRYLIC	EA	\$ 206.00
26475	HEAD ASM, LE-76PB	EA	\$ 432.00	36157	HEAD, MACHINED 0.9	EA	\$ 159.00
27082	HEAD ASM, LE-85HV	EA	\$ 400.00	36159	HEAD, MACHINED 3.0	EA	\$ 238.00
25660	HEAD ASM, LE-86/86HV	EA	\$ 400.00	49329	Head, machined SC2 HV Acrylic	EA	\$ 166.00
26476	HEAD ASM, LE-86PB	EA	\$ 432.00	49332	Head, machined SC2 HV Ported PP	EA	\$ 349.00
35151	HEAD ASM, LE-86PBA	EA	\$ 432.00	49331	Head, machined SC2 HV PP	EA	\$ 149.00
38377	HEAD KIT, 0.9 MOLDED	EA	\$ 106.00	49334	Head, machined SC3 HV Acrylic	EA	\$ 203.00
28390	HEAD, 0.5 ACRYLIC	EA	\$ 189.00	49337	Head, machined SC3 HV Ported PP	EA	\$ 349.00
38571	HEAD, 0.5 ACRYLIC HV	EA	\$ 262.00	49336	Head, machined SC3 HV PP	EA	\$ 149.00
38571-1	HEAD, 0.5 ACRYLIC HV	EA	\$ 370.00	49339	Head, machined SC4 HV Acrylic	EA	\$ 167.00
38578	HEAD, 0.5 MACHINED	EA	\$ 175.00	49342	Head, machined SC4 HV Ported PP	EA	\$ 349.00
38579	HEAD, 0.5 MACHINED PVC	EA	\$ 160.00	49341	Head, machined SC4 HV PP	EA	\$ 149.00
37750	HEAD, 0.5 MOLDED PVC	EA	\$ 68.00	48214	HEAD, MACHINED, SC1 ACL	EA	\$ 152.00
37980	HEAD, 0.5 MOLDED PVDF(DEEP COR	EA	\$ 102.00	48216	HEAD, MACHINED, SC1 PP	EA	\$ 186.00
28391	HEAD, 0.5 PP	EA	\$ 276.00	48218	HEAD, MACHINED, SC2 ACL	EA	\$ 158.00
38572	HEAD, 0.5 PP HV	EA	\$ 227.00	48220	HEAD, MACHINED, SC2 PP	EA	\$ 163.00
38572-1	HEAD, 0.5 PP HV	EA	\$ 338.00	48219	HEAD, MACHINED, SC2 PVC	EA	\$ 122.00
29609	HEAD, 0.5 PVDF	EA	\$ 113.00	48222	HEAD, MACHINED, SC3 ACL	EA	\$ 283.00
32506	HEAD, 0.5 SS 316	EA	\$ 386.00	48224	HEAD, MACHINED, SC3 PP	EA	\$ 170.00
25550	HEAD, 0.9 ACRYLIC HV	EA	\$ 209.00	48226	HEAD, MACHINED, SC4 ACL	EA	\$ 172.00
38568	HEAD, 0.9 ACRYLIC HV	EA	\$ 189.00	36128	HEAD, MOLDED 3.0 PVDF	EA	\$ 193.00
38568-1	HEAD, 0.9 ACRYLIC HV	EA	\$ 222.00	48363	HEAD, MOLDED FASTPRIME SC2	EA	\$ 82.00
38561	HEAD, 0.9 MACHINED	EA	\$ 175.00	48364	HEAD, MOLDED FASTPRIME SC2	EA	\$ 88.00
38562	HEAD, 0.9 MACHINED PVC	EA	\$ 146.00	48366	HEAD, MOLDED FASTPRIME SC3	EA	\$ 130.00
37752	HEAD, 0.9 MOLDED PVC	EA	\$ 78.00	48367	HEAD, MOLDED FASTPRIME SC3	EA	\$ 143.00
26050-1	HEAD, 0.9 PP HV	EA	\$ 329.00	48369	HEAD, MOLDED FASTPRIME SC4	EA	\$ 134.00
38569	HEAD, 0.9 PP HV	EA	\$ 235.00	48370	HEAD, MOLDED FASTPRIME SC4	EA	\$ 129.00
38569-1	HEAD, 0.9 PP HV	EA	\$ 224.00	48471	HEAD, SC1, 316 SS	EA	\$ 417.00
29611	HEAD, 0.9 PVDF	EA	\$ 161.00	48472	HEAD, SC2, 316 SS	EA	\$ 407.00
32507	HEAD, 0.9 SS 316	EA	\$ 438.00	48473	HEAD, SC3, 316 SS	EA	\$ 417.00
38592	HEAD, 1.8 ACRYLIC HV	EA	\$ 196.00	48474	HEAD, SC4, 316 SS	EA	\$ 417.00
38592-1	HEAD, 1.8 ACRYLIC HV	EA	\$ 231.00	28970	HOUSING ASM, 115V B7 BE	EA	\$ 207.00
38595	HEAD, 1.8 ACRYLIC MACH	EA	\$ 202.00	49031	Housing ASM, 120 V	EA	\$ 309.00
37742	HEAD, 1.8 MACHINED PVC	EA	\$ 262.00	28983	HOUSING ASM, 220-240V	EA	\$ 221.00
37754	HEAD, 1.8 MOLDED PVC	EA	\$ 130.00	35949CE	HOUSING ASM, B9X1/C9X1	EA	\$ 223.00
26040	HEAD, 1.8 PP HV	EA	\$ 257.00	35956CE	HOUSING ASM, B9X6/C9X6	EA	\$ 239.00
38593	HEAD, 1.8 PP HV	EA	\$ 207.00	32405	HOUSING ASM, C7X6	EA	\$ 230.00
38593-1	HEAD, 1.8 PP HV	EA	\$ 284.00	38411	HOUSING ASM, P1 115V	EA	\$ 166.00
38596	HEAD, 1.8 PVC MACHINED	EA	\$ 206.00	38413	HOUSING ASM, P1 230V DIN	EA	\$ 144.00
27214	HEAD, 1.8 PVDF	EA	\$ 130.00	38453	HOUSING ASM, P1X1 CE	EA	\$ 130.00
32508	HEAD, 1.8 SS 316	EA	\$ 500.00	28925	HOUSING LESS WIRES	EA	\$ 126.00
27511	HEAD, 1.8 UHMWPE SLURRY	EA	\$ 239.00	35398	HOUSING, 5 X 5 W/PG9	EA	\$ 120.00
27394	HEAD, 3.0 316 SS	EA	\$ 1,552.00	48599	HOUSING, AD	EA	\$ 276.00
10524	HEAD, 3.0 ACRYLIC	EA	\$ 277.00	29256	HOUSING, B1 SERIES	EA	\$ 178.00
10524-3	HEAD, 3.0 ACRYLIC	EA	\$ 288.00	35890	HOUSING, B9/C9	EA	\$ 254.00
37745	HEAD, 3.0 MACHINED PVC	EA	\$ 230.00	35404	HOUSING, LESS WIRES	EA	\$ 213.00
37756	HEAD, 3.0 MOLDED PVC	EA	\$ 145.00	48731	INJECTION VALVE, 8X2	EA	\$ 60.00
10681	HEAD, 3.0 PP	EA	\$ 363.00	48732	INJECTION VALVE, 8X3	EA	\$ 75.00
10681-4	HEAD, 3.0 PP	EA	\$ 524.00	48728	INJECTION VALVE, 9X0, XX8	EA	\$ 60.00
10681-3	HEAD, 3.0 PP HV	EA	\$ 315.00	48729	INJECTION VALVE, 9X5	EA	\$ 63.00
10525	HEAD, 3.0 PVC	EA	\$ 277.00	48730	INJECTION VALVE, 9X9	EA	\$ 63.00
31053	HEAD, 3.0 PVDF MOLDED	EA	\$ 172.00	48795	INJECTION VLV CARTRIDGE	EA	\$ 22.00
32509	HEAD, 3.0 SS 316	EA	\$ 417.00	48796	INJECTION VLV CARTRIDGE	EA	\$ 18.00
25718	HEAD, 6.0 ACRYLIC	EA	\$ 469.00	31031	INSERT, "A" SERIES	EA	\$ 2.00
25906	HEAD, 6.0 PP	EA	\$ 325.00	31032	INSERT, "B" SERIES	EA	\$ 4.00
25906-3	HEAD, 6.0 PP HV	EA	\$ 375.00	25301	INSERT, PACKING PSF	EA	\$ 17.00
25905	HEAD, 6.0 PVC	EA	\$ 325.00	25079	INSERT, TUBING .375 PP	EA	\$ 4.00
48429	HEAD, AUTOPRIME SC3 PVC	EA	\$ 175.00	34904	INSERT/PAD "U" AND "P"	EA	\$ 5.00
48743	HEAD, AUTOPRIME, 0.5 ACL	EA	\$ 191.00	25907	JACK ASM, W/FLAG	EA	\$ 25.00

NOTE * - To purchase tubing in foot increments, contact your local distributor.

CONFIDENTIAL - FOR INTERNAL USE ONLY

All information and prices herein are subject to change without notice.

PARTS
by Description

Part Number	Description	UM	Price	Part Number	Description	UM	Price
28907	JACK ASM, W/STRAIGHT	EA	\$ 25.00	10166	O-RING, 3.989 ID X .070 W BUNA N	EA	\$ 6.00
50657	Kit- Tube Adapter - PVDF w/Polyprel o-rings	EA	\$ 7.10	35269	O-RING, 4.984 ID X .139	EA	\$ 10.00
50658	Kit -Tube Adapter-PVDF w/PTFE o-rings	EA	\$ 8.90	48590	O-RING, PTFE, 2-007 , WHITE	EA	\$ 1.00
28998	KIT, DIS VLV 1/4 TUBE	EA	\$ 30.00	48591	O-RING, PTFE, 2-111	EA	\$ 3.00
31290	KIT, METRIC TUBING	EA	\$ 38.00	48589	O-RING, PTFE, 2-113	EA	\$ 3.00
37349	KIT, REPLACEMENT, SPRING LOADED LIQUIPRO IN	EA	\$ 13.00	32352	O-RING, SPONGE	EA	\$ 3.60
10930	KIT, SEAL RING TEFLON	EA	\$ 35.00	48966	O-RING,,176IDX.070W,PTFE-008	EA	\$ 2.00
25197	KIT, SEAL RING TEFLON	EA	\$ 44.00	49137	O-RING,,362IDX.103W,PTFE	EA	\$ 3.00
10884	KIT, SEAL RING VITON 1/2	EA	\$ 64.00	30904-1	PACK JOINT, 3/4	EA	\$ 240.00
10928	KIT, SEAL RING VITON 3/8	EA	\$ 31.00	33820	PANEL ASM, CONTROL	EA	\$ 750.00
30709B	KNOB ASM	EA	\$ 7.00	36256	PANEL W/NAMEPLATE, B1/C1	EA	\$ 36.00
31890	KNOB ASM, "A" SERIES	EA	\$ 12.00	35744	PIN, DUAL	EA	\$ 4.00
31891	KNOB ASM, "B" SERIES	EA	\$ 12.00	32883	PIN, SPRING KNOB STOP	EA	\$ 6.00
30295	KNOB ASM, 1/4 COLLET	EA	\$ 14.00	32578	PINION, THREAD ASM. 4.2C	EA	\$ 36.00
25889	KNOB, "A"	EA	\$ 19.00	10789	PIPE, 1/2" SCHEDULE 80	EA	\$ 22.00
25891	KNOB, B7, D7	EA	\$ 29.00	26558	PLUG, 1/4 NPT PVC	EA	\$ 16.00
30709	KNOB, PUSH-ON	EA	\$ 8.00	25648	PLUG, 3/4 - 16 PP YELLOW	EA	\$ 2.00
30643	LABEL COVER, CLEAR	EA	\$ 1.00	34114	Plug, Audio 3.5 MM	EA	\$ 3.00
35184	LABEL SET, SILVER (BLANK)	EA	\$ 2.00	10436	PLUG, CAP .375 OD, PE (YELLOW)	EA	\$ 1.00
27235	LABEL, CALIBRATION 35 GA	EA	Obsolete	30744	PLUG, CAP 1-14	EA	\$ 1.00
27236	LABEL, CALIBRATION LITER	EA	\$ 5.20	10346	PLUG, PE (BLACK)	EA	\$ 1.00
28410	LABEL, MODEL # FIELD	EA	\$ 3.00	30307	PLUG, PUSH IN	EA	\$ 1.00
25452	LABEL, PUMP INSTRUCTION	EA	\$ 0.52	48534	PLUNGER ASM, SC1	EA	\$ 87.00
26651	LIGHT ASM, SATURATOR	EA	\$ 63.00	48535	PLUNGER ASM, SC2-4	EA	\$ 87.00
37334	Liquid End Cartridge	EA	\$ 22.00	50659	Pole Piece Ass'y - Excel AD - 120 V	EA	\$ 366.00
37335	Liquid End Cartridge	EA	\$ 26.00	50660	Pole Piece Ass'y - Excel AD - 240 V	EA	\$ 305.00
37337	Liquid End Cartridge	EA	\$ 22.00	50661	Pole Piece Ass'y-Excel AD-Universal Voltage	EA	\$ 350.00
37338	Liquid End Cartridge	EA	\$ 26.00	32428	POTENTIOMETER ASM	EA	\$ 87.30
37858	Liquid End Cartridge	EA	\$ 22.00	32448	POTENTIOMETER W/HDWR, 1 MEG SPDT	EA	\$ 29.00
37859	Liquid End Cartridge	EA	\$ 22.00	48033	PTFE PLUNGER SEAL, LE-987	EA	\$ 106.00
49109	LIQUID END HARDWARE, 4XX, DXX	EA	\$ 7.00	26006	PULSE TRANSMITTER (A7, B7, C7, and P7)	EA	\$ 80.00
48703	LIQUID END HARDWARE, 7XX, 8XX	EA	\$ 7.00	41319	PULSE TRANSMITTER (AA7 ONLY)	EA	\$ 138.00
48702	LIQUID END HARDWARE, 9XX	EA	\$ 7.00	48489	PULSE TRANSMITTER, ROYTRONIC	EA	\$ 104.00
30916	LIQUIFRAM, 0.5 FLUORFILM	EA	\$ 80.00	50663	PULSER ASM, AD2	EA	\$ 420.00
30917	LIQUIFRAM, 0.9 FLUORFILM	EA	\$ 85.00	50664	PULSER ASM, AD8	EA	\$ 450.00
31420	LIQUIFRAM, 1.8 FLUORFILM	EA	\$ 90.00	50665	PULSER ASM, AD9	EA	\$ 555.00
31419	LIQUIFRAM, 3.0 FLUORFILM (NON FABRIC)	EA	\$ 95.00	30955	PULSER W/LABEL, DC 12A	EA	\$ 285.00
25719	LIQUIFRAM, 6.0 FLUORFILM (NON FABRIC)	EA	\$ 130.00	35708	PULSER, 115V AA1	EA	\$ 98.00
48186	LIQUIFRAM, SC1	EA	\$ 80.00	36255	PULSER, AA1/A1 REPLACEMENT	EA	\$ 116.00
48187	LIQUIFRAM, SC2	EA	\$ 85.00	36254	PULSER, FIXED	EA	\$ 116.00
48188	LIQUIFRAM, SC3	EA	\$ 90.00	37823	REPLACEMENT PULSER, P7/AA7 115V	EA	\$ 293.00
48189	LIQUIFRAM, SC4	EA	\$ 95.00	37824	REPLACEMENT PULSER, P7/AA7 230V	EA	\$ 307.00
33256	MAGNET, DIGIPULSE	EA	\$ 49.00	27398-1	RETAINER TUBE, 35 GALLON TANK	EA	\$ 75.00
26576	MOTOR, AGITATOR 115V	EA	\$ 622.00	48313	RETAINING RING, 8MM	EA	\$ 5.00
35243	MOV/CAP ASM, AA1X1/AA7X1 120V	EA	\$ 27.00	34116	RING, ANTI-FRICTION	EA	\$ 5.00
35237	MOV/CAP ASM, AA1XX/AA7XX 230V	EA	\$ 20.00	10422	RING, RETAINING	EA	\$ 1.00
48842	NAMEPLATE, AD2	EA	\$ 39.00	10462	RING, RETAINING	EA	\$ 0.52
48843	NAMEPLATE, AD8	EA	\$ 50.00	27253	RING, RETAINING EXT 3/8	EA	\$ 1.00
48844	NAMEPLATE, AD9	EA	\$ 44.00	10407	RING, SEAL .375 TEFLON	EA	\$ 6.00
35083	NAMEPLATE, P1	EA	\$ 12.00	10207	RING, SEAL .375 VITON	EA	\$ 9.00
27401	NIPPLE, 1/4 CLOSE PVC	EA	\$ 7.00	25128	RING, SEAL .500 TEFLON	EA	\$ 15.00
25335	NOZZLE ASM, CORP STOP	EA	\$ 68.00	10228	RING, SEAL .500 VITON	EA	\$ 13.00
10904	NUT, 1/2	EA	\$ 2.30	50627	Roy Coup Knob - Fluoride Satuator, Agitators, Tubing Shield	EA	\$ 42.00
10143	NUT, 10-24 HEX SS	EA	\$ 1.00	49246	Roytronic Low Level Switch Assembly	EA	\$ 240.00
25628	NUT, 6-32 X HEX SS	EA	\$ 3.00	28850	SATURATOR ASM, WITH TANK	EA	\$ 2,750.00
25631	NUT, RELIEF TUBING	EA	\$ 4.00	48915	SC1 Head - replaces 48361	EA	\$ 128.00
40573	O' RING 2-016 VITON	EA	\$ 7.00	48824	SCREW	EA	\$ 1.00
48861	O-RING	EA	\$ 3.00	37144	SCREW KIT, HASTELLOY (4)	EA	\$ 127.00
32175	O-RING, .234 ID X .139 W	EA	\$ 11.00	41227	SCREW, #8 X 1 3/8, HI-LO	EA	\$ 1.00
36103	O-RING, .549 ID X .103 W POLYPREL	EA	\$ 3.00	32498	SCREW, 10-10 X 5/8 HEX HEAD	EA	\$ 0.50
33264	O-RING, .674 ID X .103 W POLYPREL	EA	\$ 2.00	30856	SCREW, 10-24 1.25L SS	EA	\$ 2.00
32176	O-RING, .676 ID X .070 W	EA	\$ 11.00	10598	SCREW, 10-24 X .625 PH SS	EA	\$ 1.00
26983	O-RING, .937 ID X .139 W	EA	\$ 5.00	10340	SCREW, 10-24 X .75 PH SS	EA	\$ 2.00
34497	O-RING, 0.25ID x 0.437OD	EA	\$ 1.00	27551	SCREW, 10-24 X 1.25 RH ST	EA	\$ 0.83
48750	O-RING, 015, FKM	EA	\$ 1.00	25127	SCREW, 10-24 X 4.5 RH SS	EA	\$ 6.00
48751	O-RING, 019, FKM	EA	\$ 1.00	25423	SCREW, 10-24 X 5/8 SET	EA	\$ 0.83
48347	O-RING, 2-008 80D AFLAS	EA	\$ 1.00	10140	SCREW, 10-24X 1.625 SS	EA	\$ 1.00
48308	O-RING, 2-011 70D BUNA-N	EA	\$ 0.50	26490	SCREW, 6-32 THUMB NY	EA	\$ 2.00
48309	O-RING, 2-017 70D BUNA-N	EA	\$ 0.50	25627	SCREW, 6-32 X 1.25 PH SS	EA	\$ 1.00
48166	O-RING, 2-049, BUNA-N	EA	\$ 2.00	34876	SCREW, BLEED	EA	\$ 6.50
48349	O-RING, 2-111, 80DUR AFLAS	EA	\$ 3.00	32395	SCREW, SELF TAPPING	EA	\$ 2.00

NOTE * - To purchase tubing in foot increments, contact your local distributor.

CONFIDENTIAL - FOR INTERNAL USE ONLY

All information and prices herein are subject to change without notice.

PARTS
by Description

Part Number	Description	UM	Price	Part Number	Description	UM	Price
30306	SCREW, SELF-TAP 10-10 X 1 SS	EA	\$ 1.00	27641-1	STUD ASM, 3.0 SI 4.2C	EA	\$ 8.00
38199	SCREW, SELF-TAP, HI-LO	EA	\$ 1.00	27641	STUD ASM, 3.5 SI 4.2C	EA	\$ 9.00
32899	SCREW, SET LIQ.SHAFT	EA	\$ 14.00	32247	STUD, SPACING	EA	\$ 5.00
34613	SEAL REPAIR KIT	EA	\$ 75.00	27187	STUD, SPACING 4.2C	EA	\$ 2.00
29443	SEAL RING, COMPOSITE 3/8	EA	\$ 11.00	48679	SUCTION CHECK VALVE	EA	\$ 75.00
31103	SEAL, 4.737 X .103 BUNA N	EA	\$ 2.10	48681	SUCTION CHECK VALVE	EA	\$ 55.00
10973	SEAL, SHAFT	EA	\$ 8.00	48684	SUCTION CHECK VALVE	EA	\$ 44.00
48158	SEAL, SHAFT, A/A+	EA	\$ 5.00	48675	SUCTION CHECK VALVE, 718	EA	\$ 32.00
59239	SENSOR ASM,RFP-075,100,150,200	EA	\$ 140.00	48676	SUCTION CHECK VALVE, 728, 738,	EA	\$ 32.00
26577	SHAFT ASM, AGITATOR 35"	EA	\$ 199.00	48677	SUCTION CHECK VALVE, 812	EA	\$ 44.00
31770	SHAFT ASM, SERIES C	EA	\$ 33.00	48678	SUCTION CHECK VALVE, 813	EA	\$ 42.00
35743	SHAFT, SPEED ADJ	EA	\$ 4.00	48680	SUCTION CHECK VALVE, 823, 833,	EA	\$ 75.00
32654	SHIM, .020 THICK 4.2	EA	\$ 7.00	48682	SUCTION CHECK VALVE, 915	EA	\$ 75.00
27586	SHIM, 3.5S 4.2C NY	EA	\$ 1.00	48683	SUCTION CHECK VALVE, 919	EA	\$ 75.00
48177	SHIM, EPU	EA	\$ 8.00	48685	SUCTION CHECK VALVE, 925, 935	EA	\$ 75.00
48177	SHIM, EPU, A/A+	EA	\$ 8.00	48686	SUCTION CHECK VALVE, 929, 939,	EA	\$ 75.00
48215	Size 1 PVC machined head	EA	\$ 63.00	48768	SUCTION CHECK VALVE, SS	EA	\$ 160.00
48223	Size 2 PVC machined head	EA	\$ 130.00	30733	SUCTION CK VALVE, LE-987	EA	\$ 580.00
25068	SLEEVE, SOLENOID	EA	\$ 70.00	55796	REED SWITCH TRANSMITTER W/ 3.5MM CONNEC	EA	\$ 93.60
35393	SPACER W/PLUG 5X5 0.9	EA	\$ 89.00	29190	SWITCH ASM, LEVEL A7 B7 D7	EA	\$ 107.00
35394	SPACER W/PLUG 5X5 1.8	EA	\$ 78.00	28291	SWITCH ASM, LEVEL-SATURATOR	EA	\$ 262.00
35395	SPACER W/PLUG 5X5 3.0	EA	\$ 78.00	26049	SWITCH ASM, LL	EA	\$ 353.00
35837	SPACER, 0.9 W/O BOSSES	EA	\$ 76.00	26731	SWITCH ASM, LL 115V	EA	\$ 522.00
27515	SPACER, 0.9SI 4.2C	EA	\$ 136.00	26732	SWITCH ASM, LL 230V	EA	\$ 542.00
35838	SPACER, 1.8 W/O BOSSES	EA	\$ 115.00	27417	SWITCH ASM, LL 35 GAL	EA	\$ 480.00
27516	SPACER, 1.8SI 4.2C	EA	\$ 131.00	33510	SWITCH ASM, LL 35 GAL (230V)	EA	\$ 500.00
35839	SPACER, 3.0 W/O BOSSES	EA	\$ 109.00	27243	SWITCH ASM, SATURATOR	EA	\$ 114.00
27517	SPACER, 3.0SI 4.2C	EA	\$ 76.00	55787	REED SWITCH TRANSMITTER W/ FLYING LEADS	EA	Consult
36905	SPACER, FM-PRO	EA	\$ 18.00	49249	Switch, Dual Liquid Level (Excel only)	EA	\$ 280.00
37558	SPARE PARTS KIT, BP/AS &	EA	\$ 132.00	26350	TANK AND COVER ASM	EA	\$ 420.00
37559	SPARE PARTS KIT, BP/AS &	EA	\$ 251.00	27400	TANK ASM, 35 GAL	EA	\$ 440.00
48657	SPEED KNOB ASSY	EA	\$ 7.70	26900	TANK ASM, SATURATOR	EA	\$ 355.00
27034	SPRING & PAD ASM, D	EA	\$ 2.00	26350-E1	TANK ASM, W/COVER HOLES	EA	\$ 1,132.00
25414	SPRING, .36 X .038 X .75	EA	\$ 4.00	26350-1	TANK W/COVER, DRILL	EA	\$ 440.00
32221	SPRING, .36 X .045 X .56	EA	\$ 1.00	34054	TANK, 15 GALLON WHITE	EA	\$ 200.00
25558	SPRING, .42 X .24 X 1.0	EA	\$ 6.00	27325	TANK, 35 GALLON	EA	\$ 1,033.00
10139	SPRING, .48 X .038 X .88 SS	EA	\$ 1.46	25688	TANK, 50 GALLON	EA	\$ 746.00
37539	SPRING, CLEAR PVDF	EA	\$ 16.00	10182-1	TERMINAL, WIRE #22-18	EA	\$ 1.00
30348	SPRING, COATED	EA	\$ 36.00	10368-1	TERMINAL, WIRE #22-18	EA	\$ 1.00
37341	SPRING, COMPRESSION	EA	\$ 5.00	25070-1	TERMINAL, WIRE #22-18	EA	\$ 1.00
48997	SPRING, DIAPHRAGM	EA	\$ 5.00	27501	THERMOSTAT ASM, 4.2C	EA	\$ 21.00
48998	SPRING, DIAPHRAGM	EA	\$ 8.00	27501CE	THERMOSTAT ASM, 4.2C	EA	\$ 21.00
48999	SPRING, DIAPHRAGM	EA	\$ 20.00	27241	TRANSFORMER ASM,	EA	\$ 79.00
48327	SPRING, DIAPHRAGM SC1, A	EA	\$ 1.00	27166	TUBE, ANTI-RISE 3/8 PIPE	EA	\$ 77.00
32879	SPRING, LG. 3.37 O.D.	EA	\$ 46.00	28636	TUBING PE, .250 OD X .062 - SEE NOTE *	FT	Consult
30374	STICKER, STROKE DIAL AX6	EA	\$ 6.60	25636-500	TUBING PE, .250 OD X .062, 500 FEET	EA	\$ 521.00
27097	STICKER, STROKE DIAL DX4	EA	\$ 6.00	28636-500	TUBING PE, .250 OD X .062, 500 FEET	EA	\$ 554.00
29837	STICKER, STROKE J04 J05	EA	\$ 16.00	25636	TUBING PE, .250 X .062 - SEE NOTE *	FT	Consult
10847-1	STRAINER, FLUORIDE SATURATOR	EA	\$ 87.00	25636-16	TUBING PE, .250 X .062, 16 FEET	EA	\$ 21.00
10123	STRAINER, FOOT VALVE PP	EA	\$ 7.00	25636-06	TUBING PE, .250 X .062, 6 FEET	EA	\$ 8.00
31898	STROKE ADJ ASM, B SERIES	EA	\$ 89.00	27342	TUBING PE, .375 OD X .062 - SEE NOTE *	FT	Consult
48012	STROKE ADJ SHAFT ASM, SERIES AA	EA	\$ 25.00	27342-10	TUBING PE, .375 OD X .062, 10 FEET	EA	\$ 16.00
48600	STROKE BRACKET	EA	\$ 16.00	27342-500	TUBING PE, .375 OD X .062, 500 FEET	EA	\$ 659.00
38886	STROKE BRACKET ADJ, SERIES AA	EA	\$ 11.00	27142	TUBING PE, .500 OD X .062 - SEE NOTE *	FT	Consult
32251	STROKE BRACKET ASM, SERIES "C"	EA	\$ 190.00	27142-500	TUBING PE, .500 OD X .062, 500 FEET	EA	\$ 592.00
32251CE	STROKE BRACKET ASM, 4.2C C SERIES	EA	\$ 182.00	10469	TUBING VINYL, .375 OD X .062 - SEE NOTE *	FT	Consult
49308	STROKE DIAL	EA	\$ 10.00	10469-500	TUBING VINYL, .375 OD X .062, 500 FT	EA	\$ 498.00
29269	STROKE DIAL, AX7	EA	\$ 7.00	10469-06	TUBING VINYL, .375 OD X .062, 6 FEET	EA	\$ 8.00
48528	STROKE DIAL, AX8	EA	\$ 9.00	25651	TUBING VINYL, .938 OD X .15 - SEE NOTE *	FT	Consult
48805	STROKE DIAL, AX8	EA	\$ 9.40	25651-3.5	TUBING VINYL, .938 OD X .15, 3.5 FT	EA	\$ 37.00
48529	STROKE DIAL, AX9	EA	\$ 9.40	25651-50	TUBING VINYL, .938 OD X .15, 50 FT	EA	\$ 518.00
25882	STROKE DIAL, BX1	EA	\$ 6.00	10342	TUBING, .375 OD X .062 PE - SEE NOTE *	FT	Consult
32465	STROKE DIAL, CX1	EA	\$ 6.00	10342-10	TUBING, .375 OD X .062 PE, 10 FEET	EA	\$ 13.00
32466	STROKE DIAL, CX2/CX6	EA	\$ 6.00	10342-500	TUBING, .375 OD X .062 PE, 500 FEET	EA	\$ 498.00
32467	STROKE DIAL, CX3	EA	\$ 7.00	10142	TUBING, .500 OD X .062 PE - SEE NOTE *	FT	Consult
32468	STROKE DIAL, CX4	EA	\$ 38.00	10142-10	TUBING, .500 OD X .062 PE, 10 FEET	EA	\$ 15.00
36178	STROKE DIAL, UX2	EA	\$ 6.00	10142-500	TUBING, .500 OD X .062 PE, 500 FEET	EA	\$ 529.00
50662	STROKE KNOB ASSY	EA	\$ 22.00	10141	TUBING, .500 OD X .062 VINYL - SEE NOTE *	FT	Consult
48656	STROKE KNOB ASSY	EA	\$ 20.00	10141-500	TUBING, .500 OD X .062 VINYL, 500 FEET	EA	\$ 550.00
48602	STROKE SHAFT, AD FEMALE	EA	\$ 42.00	54793	TUBING, UV KIT, 1/2"	EA	\$ 57.00
48601	STROKE SHAFT, AD MALE	EA	\$ 33.00	54783	TUBING, UV KIT, 1/4"	EA	\$ 26.00

NOTE * - To purchase tubing in foot increments, contact your local distributor.

CONFIDENTIAL - FOR INTERNAL USE ONLY

All information and prices herein are subject to change without notice.

PARTS
by Description

Part Number	Description	UM	Price
54784	TUBING, UV KIT, 3/8"	EA	\$ 50.00
37735	Use Kit 37824	EA	Consult
34627	VALVE ASM, 4FV 1/2 BALL	EA	\$ 145.00
34626	VALVE ASM, 4FV 1/2" BALL	EA	\$ 145.00
36633	VALVE ASM, A/S BLEED 3X6MM PVDF	EA	\$ 67.00
36635	VALVE ASM, A/S BLEED 6X8MM PVDF	EA	\$ 67.00
34638	VALVE ASM, A-S/BLEED, 1/4	EA	\$ 165.00
34641	VALVE ASM, A-S/BLEED, 1/4	EA	\$ 165.00
34640	VALVE ASM, A-S/BLEED, 1/2	EA	\$ 165.00
34639	VALVE ASM, A-S/BLEED, 3/8	EA	\$ 165.00
31137	VALVE ASM, AS/PR	EA	\$ 140.00
31683	VALVE ASM, AS/PR	EA	\$ 73.00
26035	VALVE ASM, AS/PR 1/4 NPT	EA	\$ 140.00
30600	VALVE ASM, AS/PR LE-191SU	EA	\$ 140.00
27043	VALVE ASM, AS/PR LE-72S	EA	\$ 140.00
28022	VALVE ASM, AS/PR PP 3/8	EA	\$ 100.00
31682	VALVE ASM, AS/PR PVC 3/8	EA	\$ 140.00
28046	VALVE ASM, AS/PR PVDF	EA	\$ 100.00
27051	VALVE ASM, AS/PR PVDF 1/4 NPT	EA	\$ 170.00
27048	VALVE ASM, AS/PR PVDF 3/8 OD	EA	\$ 90.00
32515	VALVE ASM, CHECK 316 SS	EA	\$ 68.00
30923	VALVE ASM, DIS LE-158	EA	\$ 37.00
28005	VALVE ASM, DIS LE-190	EA	\$ 36.00
28029	VALVE ASM, DIS LE-192	EA	\$ 48.00
28041	VALVE ASM, DIS LE-193	EA	\$ 61.00
28057	VALVE ASM, DIS LE-196	EA	\$ 35.00
10561	VALVE ASM, DIS LE-20	EA	\$ 55.00
30481	VALVE ASM, DIS LE-20PB/66PB/76PB/ 86PB	EA	\$ 73.00
33536	VALVE ASM, DIS LE-22/32	EA	\$ 75.00
27052	VALVE ASM, DIS LE-25HV/76-86PB	EA	\$ 66.00
26013	VALVE ASM, DIS LE-25P/35	EA	\$ 89.00
25156	VALVE ASM, DIS LE-25T	EA	\$ 76.00
10563	VALVE ASM, DIS LE-26	EA	\$ 64.00
25411	VALVE ASM, DIS LE-26T	EA	\$ 61.00
26019	VALVE ASM, DIS LE-34	EA	\$ 85.00
27530	VALVE ASM, DIS LE-37	EA	\$ 284.00
27611	VALVE ASM, DIS LE-71L/72L	EA	\$ 38.00
25105	VALVE ASM, DIS LE-75T	EA	\$ 45.00
25661	VALVE ASM, DIS LE-76/86,	EA	\$ 63.00
25201	VALVE ASM, DIS LE-82T	EA	\$ 48.00
27601	VALVE ASM, DIS LE-91L/91DL/92L	EA	\$ 43.00
25231	VALVE ASM, DIS LE-92T	EA	\$ 43.00
25030	VALVE ASM, DIS LE-94	EA	\$ 41.00
25074	VALVE ASM, DIS LE-95T	EA	\$ 50.00
26383	VALVE ASM, DIS LE-95V	EA	\$ 39.00
49098	VALVE ASM, DIS SPRING	EA	\$ 75.00
25179	VALVE ASM, FOOT	EA	\$ 64.00
38271	VALVE ASM, FOOT	EA	\$ 89.00
27535	VALVE ASM, FOOT LE-27/37	EA	\$ 564.00
36358	VALVE ASM, FOOT 1/2"	EA	\$ 64.00
38033	VALVE ASM, FOOT 1/2"	EA	\$ 64.00
36419	VALVE ASM, FOOT 1/2" PVDF POLYPREL	EA	\$ 64.00
36346	VALVE ASM, FOOT 1/4"	EA	\$ 64.00
36413	VALVE ASM, FOOT 1/4"	EA	\$ 65.00
38031	VALVE ASM, FOOT 1/4"	EA	\$ 64.00
36364	VALVE ASM, FOOT 1/4" NPT	EA	\$ 64.00
36422	VALVE ASM, FOOT 1/4" NPT	EA	\$ 64.00
36499	VALVE ASM, FOOT 1/4" NPT	EA	\$ 64.00
36502	VALVE ASM, FOOT 1/4" NPT	EA	\$ 64.00
38034	VALVE ASM, FOOT 1/4" NPT	EA	\$ 64.00
38035	VALVE ASM, FOOT 1/4" NPT	EA	\$ 64.00
37844	VALVE ASM, FOOT 1/4" PVDF POLYPREL	EA	\$ 64.00
28026	VALVE ASM, FOOT 192/192S	EA	\$ 64.00
36352	VALVE ASM, FOOT 3/8"	EA	\$ 64.00
36416	VALVE ASM, FOOT 3/8"	EA	\$ 64.00
38032	VALVE ASM, FOOT 3/8"	EA	\$ 64.00
37845	VALVE ASM, FOOT 3/8" PVDF POLYPREL	EA	\$ 64.00
38036	VALVE ASM, FOOT 3X6mm	EA	\$ 64.00
38037	VALVE ASM, FOOT 6X8mm	EA	\$ 64.00
28316	VALVE ASM, FOOT BARBED	EA	\$ 64.00
28276	VALVE ASM, FOOT LE-151FS	EA	\$ 64.00

Part Number	Description	UM	Price
30921	VALVE ASM, FOOT LE-158	EA	\$ 64.00
28002	VALVE ASM, FOOT LE-190/190S	EA	\$ 64.00
28014	VALVE ASM, FOOT LE-191/191S	EA	\$ 64.00
28038	VALVE ASM, FOOT LE-193/193S	EA	\$ 64.00
28054	VALVE ASM, FOOT LE-196/196S	EA	\$ 64.00
10153	VALVE ASM, FOOT LE-20/20S	EA	\$ 95.00
26021	VALVE ASM, FOOT LE-24/34	EA	\$ 95.00
26015	VALVE ASM, FOOT LE-25P	EA	\$ 95.00
25154	VALVE ASM, FOOT LE-25T, 35T	EA	\$ 95.00
10253	VALVE ASM, FOOT LE-26/26S	EA	\$ 95.00
25977	VALVE ASM, FOOT LE-36	EA	\$ 91.00
27613	VALVE ASM, FOOT LE-71L/72L	EA	\$ 64.00
25109	VALVE ASM, FOOT LE-75T	EA	\$ 65.00
25492	VALVE ASM, FOOT LE-79/89	EA	\$ 84.00
25204	VALVE ASM, FOOT LE-82T	EA	\$ 64.00
27603	VALVE ASM, FOOT LE-91DL/92L	EA	\$ 64.00
25234	VALVE ASM, FOOT LE-91T	EA	\$ 64.00
10509	VALVE ASM, FOOT LE-92V	EA	\$ 64.00
25032	VALVE ASM, FOOT LE-94	EA	\$ 64.00
25076	VALVE ASM, FOOT LE-95T	EA	\$ 64.00
33480	VALVE ASM, FT LE-32, 32S	EA	\$ 103.00
38270	VALVE ASM, INJ	EA	\$ 144.00
38027	VALVE ASM, INJ 1/2" PVC	EA	\$ 72.00
37358	VALVE ASM, INJ 1/2" PVDF	EA	\$ 75.00
37855	VALVE ASM, INJ 1/2" PVDF	EA	\$ 62.00
37360	VALVE ASM, INJ 1/4" NPT	EA	\$ 71.00
38028	VALVE ASM, INJ 1/4" NPT	EA	\$ 74.00
38025	VALVE ASM, INJ 1/4" PVC	EA	\$ 60.00
37354	VALVE ASM, INJ 1/4" PVDF	EA	\$ 75.00
37848	VALVE ASM, INJ 1/4" PVDF	EA	\$ 93.00
27080	VALVE ASM, INJ 25HV 75HV	EA	\$ 88.00
38026	VALVE ASM, INJ 3/8" PVC	EA	\$ 60.00
37356	VALVE ASM, INJ 3/8" PVDF	EA	\$ 71.00
37849	VALVE ASM, INJ 3/8" PVDF	EA	\$ 79.00
38029	VALVE ASM, INJ 4X6mm	EA	\$ 62.00
38030	VALVE ASM, INJ 6X8mm	EA	\$ 89.00
25273	VALVE ASM, INJ 71FS 81FS	EA	\$ 64.00
25104	VALVE ASM, INJ 75S 85S	EA	\$ 75.00
25203	VALVE ASM, INJ CHECK	EA	\$ 82.00
32514	VALVE ASM, INJ CHECK SS	EA	\$ 84.00
25073	VALVE ASM, INJ CHK	EA	\$ 74.00
10764	VALVE ASM, INJ CK	EA	\$ 63.00
25029	VALVE ASM, INJ CK	EA	\$ 75.00
25178	VALVE ASM, INJ CK	EA	\$ 62.00
25687	VALVE ASM, INJ CK	EA	\$ 64.00
32087	VALVE ASM, INJ CK	EA	\$ 103.00
28025	VALVE ASM, INJ CK 192/192S	EA	\$ 92.00
28275	VALVE ASM, INJ CK LE-151FS	EA	\$ 73.00
30919	VALVE ASM, INJ CK LE-158	EA	\$ 90.00
28001	VALVE ASM, INJ CK LE-190/190S	EA	\$ 62.00
28013	VALVE ASM, INJ CK LE-191/191S	EA	\$ 60.00
28037	VALVE ASM, INJ CK LE-193/193S	EA	\$ 84.00
28053	VALVE ASM, INJ CK LE-196/196S	EA	\$ 78.00
26851	VALVE ASM, INJ CK LE-20/21	EA	\$ 75.00
25663	VALVE ASM, INJ CK LE-20H	EA	\$ 90.00
33481	VALVE ASM, INJ CK LE-22/32/32S	EA	\$ 102.00
26716	VALVE ASM, INJ CK LE-24/34/24WK/34WK	EA	\$ 115.00
26710	VALVE ASM, INJ CK LE-25P/35P	EA	\$ 125.00
26758	VALVE ASM, INJ CK LE-25T	EA	\$ 90.00
26751	VALVE ASM, INJ CK LE-26	EA	\$ 90.00
27534	VALVE ASM, INJ CK LE-27/37	EA	\$ 675.00
26713	VALVE ASM, INJ CK LE-30/36	EA	\$ 90.00
27608	VALVE ASM, INJ CK LE-62/62S	EA	\$ 76.00
27610	VALVE ASM, INJ CK LE-71	EA	\$ 77.00
27615	VALVE ASM, INJ CK LE-72	EA	\$ 71.00
27600	VALVE ASM, INJ CK LE-91L/91DL	EA	\$ 93.00
25233	VALVE ASM, INJ CK LE-92T	EA	\$ 78.00
26950	VALVE ASM, INJ CK LE-92V	EA	\$ 90.00
29523	VALVE ASM, INJ CK, 75LS	EA	\$ 77.00
10501	VALVE ASM, INJ LE-91D/91DS/91S	EA	\$ 71.00
32088	VALVE ASM, INJ. CHECK	EA	\$ 89.00

NOTE * - To purchase tubing in foot increments, contact your local distributor.

CONFIDENTIAL - FOR INTERNAL USE ONLY

All information and prices herein are subject to change without notice.

PARTS
by Description

Part Number	Description	UM	Price
31040	VALVE ASM, INJ. CHECK LE-151P	EA	\$ 122.00
49163	VALVE ASM, SUC	EA	\$ 75.00
49166	VALVE ASM, SUC	EA	\$ 75.00
38020	VALVE ASM, SUC 1/2" PVC	EA	\$ 35.00
36360	VALVE ASM, SUC 1/2" PVDF	EA	\$ 58.00
36421	VALVE ASM, SUC 1/2" PVDF	EA	\$ 39.00
36366	VALVE ASM, SUC 1/4" NPT	EA	\$ 58.00
36424	VALVE ASM, SUC 1/4" NPT	EA	\$ 41.00
36501	VALVE ASM, SUC 1/4" NPT	EA	\$ 52.00
36504	VALVE ASM, SUC 1/4" NPT	EA	\$ 39.00
38021	VALVE ASM, SUC 1/4" NPT	EA	\$ 36.00
38022	VALVE ASM, SUC 1/4" NPT	EA	\$ 36.00
38018	VALVE ASM, SUC 1/4" PVC	EA	\$ 35.00
36348	VALVE ASM, SUC 1/4" PVDF	EA	\$ 58.00
36415	VALVE ASM, SUC 1/4" PVDF	EA	\$ 75.00
37846	VALVE ASM, SUC 1/4" PVDF POLYPREL	EA	\$ 37.00
28028	VALVE ASM, SUC 192/192S	EA	\$ 42.00
38019	VALVE ASM, SUC 3/8" PVC	EA	\$ 35.00
36354	VALVE ASM, SUC 3/8" PVDF	EA	\$ 58.00
36418	VALVE ASM, SUC 3/8" PVDF	EA	\$ 58.00
37847	VALVE ASM, SUC 3/8" PVDF POLYPREL	EA	\$ 37.00
28279	VALVE ASM, SUC LE-151FS	EA	\$ 51.00
30924	VALVE ASM, SUC LE-158	EA	\$ 32.00
28004	VALVE ASM, SUC LE-190/190S	EA	\$ 30.00
28016	VALVE ASM, SUC LE-191/191S	EA	\$ 34.00
28040	VALVE ASM, SUC LE-193/193S	EA	\$ 30.00
28056	VALVE ASM, SUC LE-196/196S	EA	\$ 29.00
10562	VALVE ASM, SUC LE-20/21	EA	\$ 46.00
33482	VALVE ASM, SUC LE-22/32/32S	EA	\$ 114.00
26020	VALVE ASM, SUC LE-24	EA	\$ 68.00
27053	VALVE ASM, SUC LE-25HV/76PB	EA	\$ 71.00
25157	VALVE ASM, SUC LE-25T	EA	\$ 59.00
10564	VALVE ASM, SUC LE-26/26S	EA	\$ 46.00
25412	VALVE ASM, SUC LE-26T	EA	\$ 50.00
26014	VALVE ASM, SUC LE-35P	EA	\$ 76.00
27531	VALVE ASM, SUC LE-37	EA	\$ 202.00
27612	VALVE ASM, SUC LE-71L/72L	EA	\$ 39.00
25107	VALVE ASM, SUC LE-75T	EA	\$ 42.00
25662	VALVE ASM, SUC LE-76/86,	EA	\$ 53.00
10513	VALVE ASM, SUC LE-79/89	EA	\$ 36.00
25202	VALVE ASM, SUC LE-82T	EA	\$ 39.00
25232	VALVE ASM, SUC LE-92T	EA	\$ 34.00
25031	VALVE ASM, SUC LE-94	EA	\$ 37.00
25075	VALVE ASM, SUC LE-95T	EA	\$ 41.00
49095	VALVE ASM, SUC PP/PTFE/CER	EA	\$ 75.00
49088	VALVE ASM, SUC PVC/AFL/CER	EA	\$ 35.00
49089	VALVE ASM, SUC PVDF/AFL/CER	EA	\$ 75.00
49090	VALVE ASM, SUC PVDF/AFL/CER	EA	\$ 38.00
49093	VALVE ASM, SUC PVDF/AFL/PTFE	EA	\$ 75.00
49094	VALVE ASM, SUC PVDF/AFL/PTFE	EA	\$ 45.00
49092	VALVE ASM, SUC PVDF/PTFE/CER	EA	\$ 75.00
27602	VALVE ASM, SZUC LE-91L/91DL/92L	EA	\$ 34.00
49395	Valve Assembly discharge	EA	\$ 40.00
49398	Valve Assembly injection	EA	\$ 80.00
34610	VALVE BODY ASM, 1/2" TUBING	EA	\$ 114.00
38053	VALVE BODY W/LABEL &	EA	\$ 37.00
37229	VALVE BODY W/LABEL & WASHER, 3/8 PVDF	EA	\$ 48.00
37221	VALVE BODY W/LABEL & WASHER, 3FV 1/4 PVDF	EA	\$ 48.00
26856-1	VALVE BODY, 1/4 NPT	EA	\$ 139.00
26856	VALVE BODY, 4FV 1/2 OD	EA	\$ 48.00
30426	VALVE BODY, 4FV 1/2 OD PVC GRAY	EA	\$ 24.00
28703	VALVE BODY, 4FV 1/4 OD	EA	\$ 31.00
30424	VALVE BODY, 4FV 1/4 OD PVC	EA	\$ 14.60
26847	VALVE BODY, 4FV 3/8 OD	EA	\$ 42.00
30425	VALVE BODY, 4FV 3/8 OD PVC	EA	\$ 22.00
25869	VALVE BODY, AS/PR	EA	\$ 32.00
25870	VALVE BODY, AS/PR	EA	\$ 54.00
25870-1	VALVE BODY, AS/PR	EA	\$ 74.00
10793-1	VALVE HOUSING, .375 X	EA	\$ 39.00
25173	VALVE HOUSING, .500 X 1/2 PP	EA	\$ 34.00
10793	VALVE HOUSING, 1/2	EA	\$ 28.00

Part Number	Description	UM	Price
26033	VALVE HOUSING, 1/2 NPT	EA	\$ 53.00
28578	VALVE HOUSING, 1/2 NPT	EA	\$ 190.00
26928	VALVE HOUSING, 1/2 NPT SS	EA	\$ 264.00
10273	VALVE HOUSING, 1/2 TUBING PVC	EA	\$ 24.00
10493	VALVE HOUSING, 1/2 TUBING PVC	EA	\$ 23.00
31562	VALVE HOUSING, 1/2 TUBING PVDF	EA	\$ 41.00
35585	VALVE HOUSING, 1/2" NPT	EA	\$ 111.00
31938	VALVE HOUSING, 1/2" TUBING	EA	\$ 53.00
28665	VALVE HOUSING, 1/4	EA	\$ 20.00
28883	VALVE HOUSING, 1/4	EA	\$ 31.00
10493-1	VALVE HOUSING, 1/4 NPT	EA	\$ 27.00
31562-1	VALVE HOUSING, 1/4 NPT	EA	\$ 53.00
10393	VALVE HOUSING, 3/8	EA	\$ 22.00
10293	VALVE HOUSING, 3/8 OD TUBING PVC	EA	\$ 20.00
31332	VALVE HOUSING, BARBED PP	EA	\$ 25.00
27513	VALVE HOUSING, LE-79/89	EA	\$ 127.90
30375	VALVE HOUSING, PVC	EA	\$ 14.00
26840	VALVE HOUSING, PVDF 3/8	EA	\$ 25.00
25199	VALVE HOUSING, UHMWPE	EA	\$ 60.00
25605	VALVE HOUSING, UHMWPE	EA	\$ 533.00
26029	VALVE HOUSING, UHMWPE	EA	\$ 175.00
10792-1	VALVE SEAT, .375 X 1/4	EA	\$ 34.00
26032	VALVE SEAT, 1/2 NPT PP	EA	\$ 50.00
26001	VALVE SEAT, 1/2 NPT PVC	EA	\$ 50.00
26926	VALVE SEAT, 1/2 NPT SS	EA	\$ 182.00
10792	VALVE SEAT, 1/2 TUBING	EA	\$ 25.00
31937	VALVE SEAT, 1/2 TUBING	EA	\$ 46.00
10492	VALVE SEAT, 1/2 TUBING PVC	EA	\$ 24.00
35420	VALVE SEAT, 1/2" NPT	EA	\$ 190.00
10492-1	VALVE SEAT, 1/4 NPT	EA	\$ 25.00
31561-1	VALVE SEAT, 1/4 NPT PVDF	EA	\$ 50.00
28664	VALVE SEAT, 1/4 TUBING	EA	\$ 19.00
28882	VALVE SEAT, 1/4 TUBING	EA	\$ 29.00
10292	VALVE SEAT, 3/8 OD TUB PVC	EA	\$ 16.00
10392	VALVE SEAT, 3/8 TUBING	EA	\$ 20.00
25600	VALVE SEAT, FOOT PP	EA	\$ 29.00
30840	VALVE SEAT, FOOT PVC	EA	\$ 26.00
10978	VALVE SEAT, PP	EA	\$ 25.00
25649	VALVE SEAT, PP	EA	\$ 27.00
30383	VALVE SEAT, PVC	EA	\$ 13.00
26839	VALVE SEAT, PVDF 3/8 TUB	EA	\$ 29.00
25106	VALVE SEAT, SUC PP 1/2	EA	\$ 31.00
10206	VALVE SEAT, SUCTION PVC	EA	\$ 21.00
26024	VALVE, 1/2 NPT PVC	EA	\$ 55.00
27300	VALVE, 1/4 ANGLE PVC	EA	\$ 210.00
10828	VALVE, SOLENOID	EA	\$ 259.00
10626	VARISTOR ASM, 115V	EA	\$ 8.00
10627	VARISTOR ASM, 220-250V	EA	\$ 13.00
25268	VARISTOR ASM, 230V	EA	\$ 17.00
31255	VARISTOR ASM, 240V	EA	\$ 12.00
48043	VARISTOR, SERIES AA1X2 230V	EA	\$ 13.00
48823	WASHER,	EA	\$ 1.00
31590	WASHER, 1.25 X .68 LDPE	EA	\$ 3.10
30391	WASHER, 9/16 OD X 1/4 ID X .187	EA	\$ 1.00
36107	WASHER, CARTRIDGE VALVE	EA	\$ 1.00
10415	WASHER, CONICAL LOCK #10	EA	\$ 0.62
33377	WASHER, DIGIPULSE	EA	\$ 2.00
32302	WASHER, FLAT	EA	\$ 0.80
38490	WASHER, FLAT #10 SS 316	EA	\$ 1.00
48310	WASHER, M6 SMALL PLAIN	EA	\$ 0.50
25963	WASHER, NYLON	EA	\$ 0.62
30970	WASHER, PLUNGER ASM	EA	\$ 5.00
10322	WEIGHT, SUCTION TUBING	EA	\$ 6.00
26740	WINDOW & GASKET ASM	EA	\$ 42.00
10914	WIRE ASM	EA	\$ 4.30
27693	WIRE ASM, #18 GREEN	EA	\$ 4.47
29797	WIRE ASM, J	EA	\$ 10.00
28793	WIRE ASM.	EA	\$ 8.00
48460	WIRE HARNESS, ROYTRONIC EPU	EA	\$ 31.00
49013	WIRE HARNESS, ROYTRONIC EXCEL	EA	\$ 70.00

NOTE * - To purchase tubing in foot increments, contact your local distributor.

CONFIDENTIAL - FOR INTERNAL USE ONLY

All information and prices herein are subject to change without notice.

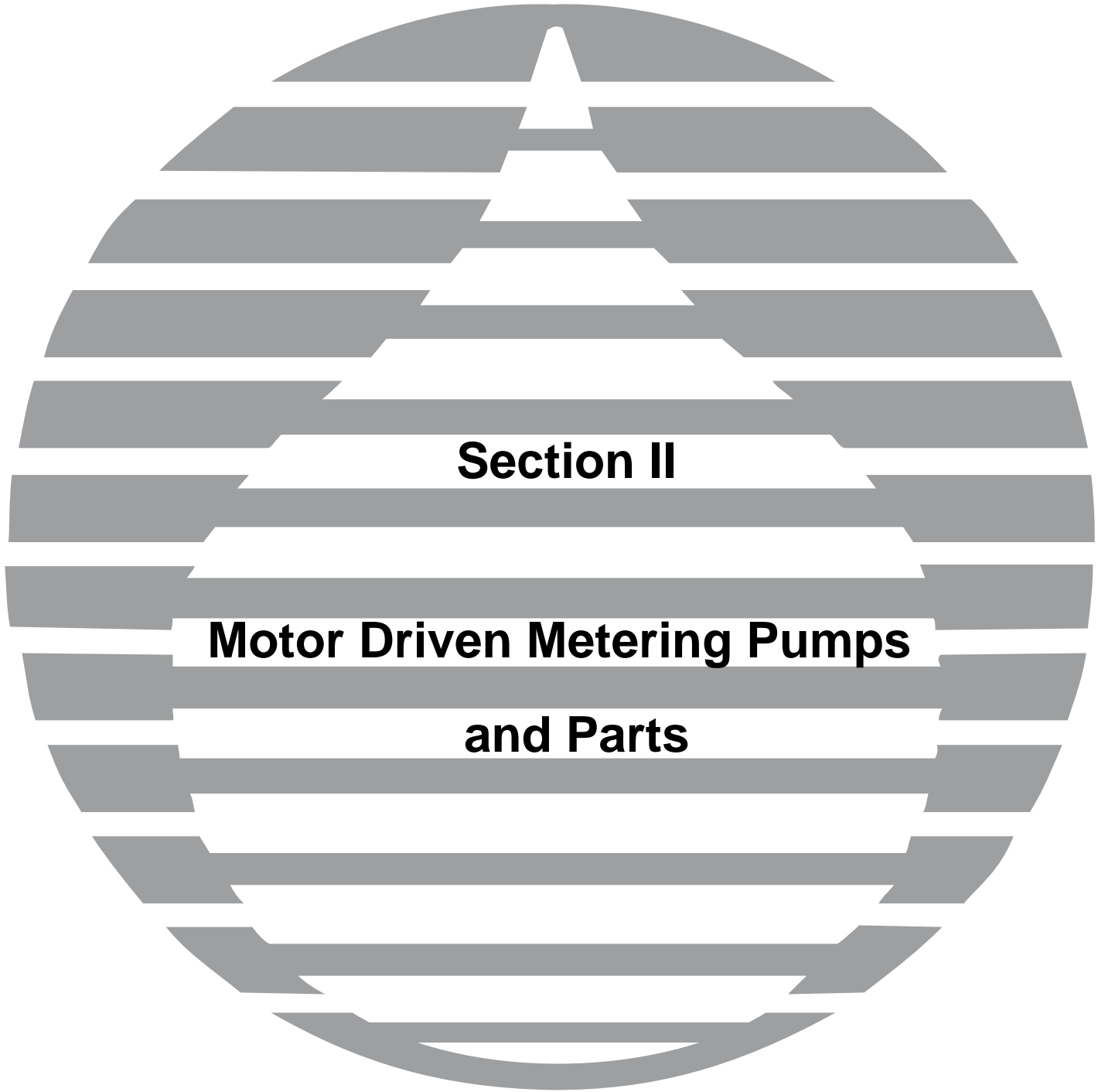

Section II

**Motor Driven Metering Pumps
and Parts**

Excel® XR

METERING PUMP SERIES



For support:



EXCEL® XR Enhanced Control Version



EXCEL® XR Enhanced Control Version



EXCEL® XR Manual Control Version



EXCEL® XR with Capacity Code 4 Polypropylene Liquid End

EXCEL[®] XR SPECIFICATIONS

General Description

The Excel™ XR Series is a technology based metering pump platform using the most effective and efficient drive systems for optimized fit into a process whether manually controlled or connected to one of many types of process control systems or signals. Each Excel™ XR pump comes with an extensive set of configurable inputs and outputs.

General Performance Specifications

- Flow rate up to 18.0 GPH (68.1 l/h)
- Pressure up to 175 psi (12.0 bar)
- Steady state accuracy +/- 1%
- Turndown 1000:1 (200:1 PTFE Seat, 500:1 FPM Seat)
- Power Required - 42 W rated (ETL)

Year of Introduction - 2016

Weights and Shipping Dimensions

Weight (approximate)	lbs	kg
Plastic Head (unboxed)	14	6.35
SS Head (unboxed)	24.5	11.1
Domestic Box	22	10

Domestic Box Dimensions	
Inches	Metric
16.5" x 18" x 13.5"	420 x 457 x 343

Temperature & Environmental Ratings

	Ambient	Process Fluid	Storage
Fahrenheit	14°F to +104°F	14°F to +104°F	-40°F to +158°F
Celsius	-10°C to +40°C	-10°C to +40°C	-40°C to +70°C

Operating humidity range:	0-95% RH (Non-condensing)
Ingress protection:	IP65 / NEMA 4X
Operation environment:	Indoor

Drive Specifications

The drive is powered by an electronically controlled variable speed stepper motor which provides accurate dosing output of the fixed stroke length drive.

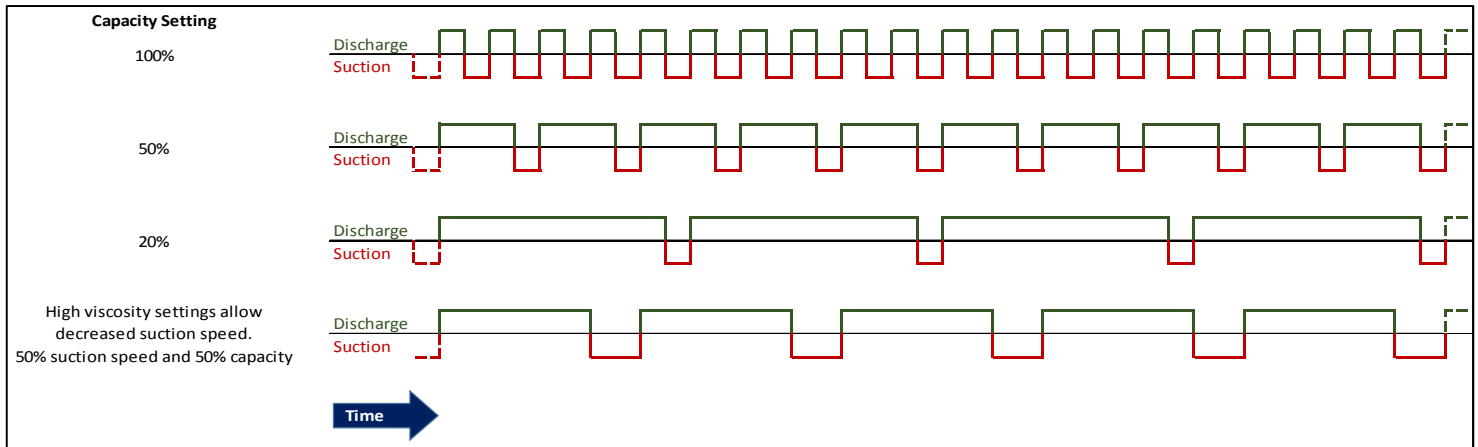

Capacity Adjustment

Variable speed stepper motor with controlled stroke profile. The profile features constant speed suction, and the discharge stroke is used to control pump capacity. This takes full advantage of the characteristics of a positive displacement pump, in that once the fluid is within the pump head, discharging it is highly controllable and predictable.

The profile also has a configurable feature allowing the suction stroke to be extended to better handle viscous fluids, or fluids with high specific gravity. The chart below indicates how the flexible stroke profile functions.

Overpressure Protection

An external safety relief valve is required for safe installation. The pump includes motor stall detection in the event of motor stall, but is not sufficient as the only means of overpressure protection.

EXCEL[®] XR SPECIFICATIONS

Lubrication System

Pump is factory lubricated for life.

Pump Housing Material

Polyphenylene ether and Polystyrene blend - 20% glass reinforced

Liquid End Specifications

Mechanically actuated diaphragm with suction and discharge ball check valves.

Materials

Refer to Price Tables for most materials

Spring Materials:

In High Viscosity Liquid ends - Spring material is 316ss

Injection Valve Spring Material - Hastelloy C 276

Performance Specifications

Turndown Ratio:	1000:1 (200:1 PTFE Seat, 500:1 FKM Seat)
Steady State Accuracy:	± 1.0%
Repetitive Accuracy:	± 3.0%
Linearity:	± 3.0%
Duty Rating:	Continuous

Suction Lift and Pressure

Drive	Max. Suction Lift		Max. Suction Inlet Pressure	
	[ft]	[m]	[psi]	[bar]
XRD_2	13.1	4	30	2
XRD_3	13.1	4	30	2
XRD_4	6.5	2	30	2

Testing

Standard Production Test: Every pump is tested to assure the pump meets capacity and pressure expectations and functions as expected.

Certifications

NSF 61

CE Compliant

ETL listed by Intertek to UL 61010-1 issued 2012/5/11 edition 3, and CSA C22.2#61010-1 issued 2012/5/11 edition 3

Dimension Drawing and Documentation

Description	No.
Customer Data Sheet	59261
Brochure	59260
Customer Dimensional Drawing	59017
Installation, Operation and Maintenance	54630
Enhanced Supplement	54772

Excel™ XR CONTROL SPECIFICATIONS

Electric Control Features	Manual	Enhanced	Comm.
User Interface			
4 Color Backlit graphical display	✓	✓	✓
Flow rate or volume display (GPH, L/hr)	✓	✓	✓
Capacity setting display	✓	✓	✓
Start/Stop button	✓	✓	✓
Mode/Select button	✓	✓	✓
Full capacity (100%) button	✓	✓	✓
Prime button	✓	✓	✓
Active operation mode indication on display	✓	✓	✓
Active alarm indication on display	✓	✓	✓
Calibration status indication on display	✓	✓	✓
Operation Modes			
Manual (Internal)	✓	✓	✓
Analog [0/4-20 mA] (External)		✓	✓
Pulse [volume/pulse] (External)		✓	✓
Batch (External)		✓	✓
Cycle Timer (Internal)		✓	✓
Timed event (Internal)		✓	✓
Control Input			
Programmable digital contacts	1	4	4
Single level float switch	✓	✓	✓
Dual low level float switch		✓	✓
Pulse control		✓	✓
Remote start/stop	✓	✓	✓
Remote internal/external mode selection		✓	✓
Programmable analog inputs	0	2	2
Pacing		✓	✓
Tank level		✓	✓
Control Protocol			
ModBus RTU*			✓
Profibus DP*			✓

*Order pump configured for your control protocol

Excel™ XR
CONTROL SPECIFICATIONS

Electric Control Features

Manual Enhanced Comm.

Control Output			
Programmable digital contacts	0	2	2
Pump running		✓	✓
Pump standby/stopped [not pumping, but ready]		✓	✓
Alarm status		✓	✓
User alarm status		✓	✓
Internal/External mode indication		✓	✓
Pump stopped		✓	✓
Stroke pulse		✓	✓
Timed event running		✓	✓
Programmable analog output	0	1	1
Flow rate [4-20 mA correlates to 0 - max capacity]		✓	✓
Mirror analog input 1		✓	✓
Power supply for remote device [24V] (eg. Flow sensor)	0	1	1
Operation functions			
Capacity control by motor speed variation	✓	✓	✓
Variable stroke profile (variable discharge speed/constant suction speed)	✓	✓	✓
Slow suction mode for viscous or degassing media	✓	✓	✓
Calibration function (single point)	✓	✓	✓
Prime feature (max capacity) button, timer	✓	✓	✓
Totalizer (Strokes, Volume, Hours Motor Operation, # Power Cycles)	✓	✓	✓
Keypad lock (software driven with password)	✓	✓	✓
Clock feature (Date and 12 hour time)	✓	✓	✓
Diaphragm replacement mode (sets stroke to extended position)	✓	✓	✓
Display firmware revision	✓	✓	✓
Load factory defaults	✓	✓	✓
Battery to maintain date and time settings when mains power removed	✓	✓	✓
EEPROM nonvolatile memory (configurations saved/powers up in last used mode)	✓	✓	✓
Internal/External input control mode configuration	✓	✓	✓
Alarm output mask configuration (configure what events trigger alarm output)	✓	✓	✓
Analog input response curve customization		✓	✓
Input pulse width setting		✓	✓
Start/Stop via remote signal	✓	✓	✓
Pump switch off on tank empty	✓	✓	✓
ModBus RTU / ProfiBus DP protocol			✓

EXCEL® XR PUMP SELECTION AND PRICING

OUTPUT CODE 2

5.6 GPH (21.2 LPH); 175 psi (12 bar)

Note: High Viscosity option and PE tube limited to 150 psi (10.3 bar)

XRDx2										
Drive End										
Control	Description	Cordset Included			Part Number			Price		
XRD12	Manual Control	-			-			See Note	\$ 2,261	
XRD92	Enhanced Control	4 Pin Cordset			54711				\$ 2,622	
XRDP2	Enhanced Control with ProfiBus	4 Pin, 5 Pin, 6 Pin Cordset			54711, 49035, 55199				\$ 3,154	
XRDM2	Enhanced Control with ModBus	4 Pin, 5 Pin, 6 Pin Cordset			54711, 49035, 55199				\$ 3,154	
Power Code		Voltage		Plug						
1		110/240V		110 - 120 VAC 1 Phase US Plug						
2		220/240V		220 - 240 VAC 1 Phase US Plug						
3		220/240V		220 - 240 VAC 1 Phase DIN Plug						
5		220/240V		220 - 240 VAC 1 Phase UK Plug						
6		220/240V		220 - 240 VAC 1 Phase Australia / New Zealand Plug						
Liquid End		Head	Seat	Balls	Check Valve Body	Max Turndown Ratio	RPM Kit			
							Standard	DN15 Conn.		
Standard Plastic										
A44AC		PP	TFE/P	Ceramic	PVDF	1000:1	RPM54771	RPM54772	\$ 270	
A44A1		PP	TFE/P	316L	PVDF	1000:1	RPM54778	RPM54779	\$ 260	
A44AT		PP	TFE/P	PTFE	PVDF	1000:1	RPM56409	RPM56410	\$ 260	
A74TC		PVDF	PTFE	Ceramic	PVDF	200:1	RPM54773	RPM54774	\$ 438	
A74AT		PVDF	TFE/P	PTFE	PVDF	1000:1	RPM56409	RPM56410	\$ 428	
Standard Metallic										
A1411		316L	316L	316L	316L	1000:1	see below		\$ 770	
Slurry										
S1414		316L	316L	440C	316L	1000:1	RPM54776		\$ 826	
High Viscosity										
V44T1		PP	PTFE	316L	PP	1000:1	RPM54777		\$ 260	
Standard Plastic		Diaphragm		O-Rings	Fittings	Connections	Tubing Kit	RPM Kit		
A7T1		PTFE/PVDF		TFE/P	PVDF	Imperial Tube	1	-	\$ 238	
A7PN		PTFE/PVDF		TFE/P	PVDF	1/2" NPT/BSP	-	-	\$ -	
A7M2		PTFE/PVDF		TFE/P	PVDF	Metric Tube	2	-	\$ 95	
A2FN		PTFE/PVDF		TFE/P	PVDF/PVC	DN15 Female	-	see above	\$ 45	
A7DN	PVDF heads only	PTFE/PVDF		TFE/P	PVDF	DN15 Male	-	see above	\$ 432	
Standard Metallic										
A1PN		PTFE/316L		TFE/P	316L	1/2" NPT/BSP	-	RPM56407	\$ -	
V1PN		PTFE/316L		FKM	316L	1/2" NPT/BSP	-	RPM54775	\$ -	
Slurry										
V1PN		PTFE/316L		FKM	316L	1/2" NPT/BSP	-	-	\$ -	
High Viscosity										
N4T3		PTFE/PVDF		-	PP	Imperial Tube	3	-	\$ 126	
XRD12	1	A44AC	A7T1							

RPM Kit	Price	RPM Kit	Price	Contents
RPM54771	\$ 331	RPM54777	\$ 314	<ul style="list-style-type: none"> • Primary Diaphragm • Secondary Diaphragm housing seal • Required O-rings • Replacable Check valves or components
RPM54772	\$ 319	RPM54778	\$ 329	
RPM54773	\$ 329	RPM54779	\$ 318	
RPM54774	\$ 318	RPM56407	\$ 821	
RPM54775	\$ 595	RPM56409	\$ 337	
RPM54776	\$ 687	RPM56410	\$ 340	

Note: Cordsets from the accessories table may be required for the customer to connect to desired input/output.

For **Tubing Kit** contents, please refer to page 83

For accessory kits and pricing, see XRD Accessories page

EXCEL® XR PUMP SELECTION AND PRICING

OUTPUT CODE 3

14.0 GPH (53.0 LPH); 75 psi (5 bar)

XRDx3										
Drive End										
Control	Description	Cordset Included			Part Number			Price		
XRD13	Manual Control	-			-			See Note	\$ 2,380	
XRD93	Enhanced Control	4 Pin Cordset			54711				\$ 2,760	
XRDP3	Enhanced Control with ProfiBus	4 Pin, 5 Pin, 6 Pin Cordset			54711, 49035, 55199				\$ 3,320	
XRDM3	Enhanced Control with ModBus	4 Pin, 5 Pin, 6 Pin Cordset			54711, 49035, 55199				\$ 3,320	
Power Code		Voltage		Plug						
1		110/240V		110 - 120 VAC 1 Phase US Plug						
2		220/240V		220 - 240 VAC 1 Phase US Plug						
3		220/240V		220 - 240 VAC 1 Phase DIN Plug						
5		220/240V		220 - 240 VAC 1 Phase UK Plug						
6		220/240V		220 - 240 VAC 1 Phase Australia / New Zealand Plug						
Liquid End		Head	Seat	Balls	Check Valve Body	Max Turndown Ratio	RPM Kit			
							Standard	DN15 Conn.		
Standard Plastic										
A44AC		PP	TFE/P	Ceramic	PVDF	1000:1	RPM54771	RPM54772	\$ 270	
A44A1		PP	TFE/P	316L	PVDF	1000:1	RPM54778	RPM54779	\$ 260	
A44AT		PP	TFE/P	PTFE	PVDF	1000:1	RPM56409	RPM56410	\$ 260	
A74TC		PVDF	PTFE	Ceramic	PVDF	200:1	RPM54773	RPM54774	\$ 438	
A74AT		PVDF	TFE/P	PTFE	PVDF	1000:1	RPM56409	RPM56410	\$ 428	
Standard Metallic										
A1411		316L	316L	316L	316L	1000:1	see below		\$ 770	
Slurry										
S1414		316L	316L	440C	316L	1000:1	RPM54776		\$ 826	
High Viscosity										
V44T1		PP	PTFE	316L	PP	1000:1	RPM54777		\$ 260	
		Standard Plastic		Diaphragm	O-Rings	Fittings	Connections	Tubing Kit	RPM Kit	
A7T1				PTFE/PVDF	TFE/P	PVDF	Imperial Tube	1	-	
A7PN				PTFE/PVDF	TFE/P	PVDF	1/2" NPT/BSP	-	-	
A7M2				PTFE/PVDF	TFE/P	PVDF	Metric Tube	2	-	
A2FN				PTFE/PVDF	TFE/P	PVDF/PVC	DN15 Female	-	see above	
A7DN	PVDF heads only			PTFE/PVDF	TFE/P	PVDF	DN15 Male	-	see above	
Standard Metallic										
A1PN				PTFE/316L	TFE/P	316L	1/2" NPT	-	RPM56407	
V1PN				PTFE/316L	FKM	316L	1/2" NPT	-	RPM54775	
Slurry										
V1PN				PTFE/316L	FKM	316L	1/2" NPT	-	-	
High Viscosity										
N4T3				PTFE/PVDF	-	PP	Imperial Tube	3	-	
XRD13	1	A44AC	A7T1							

RPM Kit	Price	RPM Kit	Price	Contents
RPM54771	\$ 331	RPM54777	\$ 314	<ul style="list-style-type: none"> • Primary Diaphragm • Secondary Diaphragm housing seal • Required O-rings • Replacable Check valves or components
RPM54772	\$ 319	RPM54778	\$ 329	
RPM54773	\$ 329	RPM54779	\$ 318	
RPM54774	\$ 318	RPM56407	\$ 821	
RPM54775	\$ 595	RPM56409	\$ 337	
RPM54776	\$ 687	RPM56410	\$ 340	

Note: Cordsets from the accessories table may be required for the customer to connect to desired input/output.

For **Tubing Kit** contents, please refer to page 83

For accessory kits and pricing, see XRD Accessories page

EXCEL® XR PUMP SELECTION AND PRICING

OUTPUT CODE 4

18.0 GPH (68.1 LPH); 50 psi (3.5 bar)

XRDx4											
Drive End									Price		
Control	Description	Cordset Included			Part Number						
XRD14	Manual Control	-			-			See Note	\$ 2,420		
XRD94	Enhanced Control	4 Pin Cordset			54711				\$ 2,800		
XRDP4	Enhanced Control with ProfiBus	4 Pin, 5 Pin, 6 Pin Cordset			54711, 49035, 55199				\$ 3,360		
XRDM4	Enhanced Control with ModBus	4 Pin, 5 Pin, 6 Pin Cordset			54711, 49035, 55199				\$ 3,360		
Power Code		Voltage		Plug							
1		110/240V		110 - 120 VAC 1 Phase US Plug						\$ -	
2		220/240V		220 - 240 VAC 1 Phase US Plug						\$ -	
3		220/240V		220 - 240 VAC 1 Phase DIN Plug						\$ -	
5		220/240V		220 - 240 VAC 1 Phase UK Plug						\$ -	
6		220/240V		220 - 240 VAC 1 Phase Australia / New Zealand Plug						\$ -	
Liquid End	Head	Seat	Balls	Check Valve Body	Diaphragm	Max Turndown Ratio	RPM Kit				
Standard PP											
A46VC	PP	FKM	Ceramic	PP	PTFE	500:1	RPM54780			\$ 380	
A46V1	PP	FKM	316L	PP	PTFE	500:1	RPM54784			\$ 370	
A46AC	PP	TFE/P	Ceramic	PP	PTFE	500:1	RPM56405			\$ 380	
A46A1	PP	TFE/P	316L	PP	PTFE	500:1	RPM56406			\$ 370	
Standard PVDF											
A76VC	PVDF	FKM	Ceramic	PVDF	PTFE	500:1	RPM54780			\$ 700	
A76AT	PVDF	TFE/P	PTFE	PVDF	PTFE	500:1	RPM56411			\$ 690	
A76AC	PVDF	TFE/P	Ceramic	PVDF	PTFE	500:1	RPM56405			\$ 700	
Standard Metallic											
A1611	316L	316L	316L	316L	PTFE	1000:1	see below			\$ 1,060	
Slurry											
S1614	316L	316L	440C	316L	PTFE	1000:1	RPM54783			\$ 1,116	
High Viscosity											
V46T1	PP	PTFE	PTFE	PP	PTFE	1000:1	RPM54782			\$ 370	
Standard PP		O-Rings	Fittings	Connections	Tubing Kit		RPM Kit				
N4PN		-	PP	1/2" NPT	-		-			\$ -	
N4TN		-	PP	Imperial Tube	-		-			\$ -	
N2FN		-	PP/PVC	DN15 Female	-		-			\$ 45	
Standard PVDF											
N2FN		-	PVDF/PVC	DN15 Female	-		-			\$ 45	
N7PN		-	PVDF	1/2" NPT	-		-			\$ -	
N7TN		-	PVDF	Imperial Tube	-		-			\$ -	
Standard Metallic											
A1PN		TFE/P	316L	1/2" NPT	-		RPM56408			\$ -	
V1PN		FKM	316L	1/2" NPT	-		RPM54781			\$ -	
Slurry											
V1PN		FKM	316L	1/2" NPT	-		-			\$ -	
High Viscosity											
N4P4		-	PP	1/2" NPT	4		-			\$ 310	
N4T4		-	PP	Imperial Tube	4		-			\$ 310	
XRD14	1	A46VC	N4PN								

Note: Cordsets from the accessories table may be required for the customer to connect to desired input/output.

For **Tubing Kit** contents, please see next page

For RPM Kit Prices, see next page

EXCEL® XR PUMP SELECTION AND PRICING

RPM Kit	Price	Contents
RPM54780	\$ 161	
RPM54781	\$ 617	
RPM54782	\$ 189	• Primary Diaphragm
RPM54783	\$ 664	• Secondary Diaphragm
RPM54784	\$ 158	housing seal
RPM56405	\$ 222	• Required O-rings
RPM56406	\$ 217	• Replacable Check valves or
RPM56408	\$ 657	components
RPM56411	\$ 242	

Tubing Kit		Tubing Kit	
1	• Injection Valve	3	• Injection Valve
	• Foot Valve		• 2m Reinforced PVC hose 15x23mm (Suction)
2	• 1 Weight (Suction Tubing)	4	• 3m PE Tube 1/2" (Discharge)
	• 16' PE Tube 3/8"		• 1 Suction hose fitting (1/2" FNPT X 15x23 hose) & 2 hose clamps
	• 20" Reinforced PVC Hose 1/4" x 1/2"		• 2m Reinforced PVC hose 15x23mm (Suction)
			• 1 suction hose fitting (1/2" FNPT X 15x23 hose) & 2 hose clamps
	• Injection Valve		
	• Foot Valve		
	• 1 Weight (Suction Tubing)		
	• Metric Ferrules 6x12mm		
	• 6m Reinforced PVC Hose 6x12mm		

ACCESSORY KITS

OUTPUT CODE 2 & 3

Part No.	Imperial Connections	Price
Description		
PP Head, 316 SS Balls		
58982	Injection Valve, PTFE	\$ 62.00
58987	Foot Valve, Mixed	\$ 56.00
59008	Connection Kit, 0.375 and 0.25x0.5	\$ 268.00
Tubing Kit, includes:		
10342-10	3/8" TUBE X 10 FT	\$ 13.00
54342-20	1/4" x 1/2" HOSE x 20 FT	\$ 80.00
PP Head, Ceramic Balls		
58983	Injection Valve, Mixed	\$ 62.00
58985	Foot Valve, Aflas	\$ 56.00
59008	Connection Kit, 0.375 and 0.25x0.5	\$ 268.00
Tubing Kit, includes:		
10342-10	3/8" TUBE X 10 FT	\$ 13.00
54342-20	1/4" x 1/2" HOSE x 20 FT	\$ 80.00
PVDF Head, Ceramic Balls		
58983	Injection Valve, Mixed	\$ 62.00
58986	Foot Valve, PTFE	\$ 56.00
59008	Connection Kit, 0.375 and 0.25x0.5	\$ 268.00
Tubing Kit, includes:		
10342-10	3/8" TUBE X 10 FT	\$ 13.00
54342-20	1/4" x 1/2" HOSE x 20 FT	\$ 80.00

Part No.	Metric Connections	Price
Description		
PP Head, 316 SS Balls		
58982	Injection Valve, PTFE	\$ 62.00
58987	Foot Valve, Mixed	\$ 56.00
59009	Connection Kit, 6x12	\$ 64.00
Tubing Kit, includes:		
36181-6M	8mm TUBE X 6m	\$ 24.00
70121-6M	6x12mm HOSE X 6m	\$ 32.00
PP Head, Ceramic Balls		
58983	Injection Valve, Mixed	\$ 62.00
58985	Foot Valve, Aflas	\$ 56.00
59009	Connection Kit, 6x12	\$ 64.00
Tubing Kit, includes:		
36181-6M	8mm TUBE X 6m	\$ 24.00
70121-6M	6x12mm HOSE X 6m	\$ 32.00
PVDF Head, Ceramic Balls		
58983	Injection Valve, Mixed	\$ 62.00
58986	Foot Valve, PTFE	\$ 56.00
59009	Connection Kit, 6x12	\$ 64.00
Tubing Kit, includes:		
36181-6M	8mm TUBE X 6m	\$ 24.00
70121-6M	6x12mm HOSE X 6m	\$ 32.00
High Viscosity		
58984	Injection Valve, HV	\$ 62.00
59010	Connection Kit, Hose Clamp	\$ 28.00
59013	Tubing Kit, HV	\$ 41.00

OUTPUT CODE 4

Part No.	Imperial Connections	Price
Description		
PP Head		
26758	Injection Valve, 0.5" Tube, PP, PTFE, Cer	\$ 90.00
25154	Foot Valve, 0.5" Tube, PP, PTFE, Cer	\$ 95.00
77384	Connection Kit, 0.5" Tubing	\$ 14.00
PVDF Head		
33481	Injec. Valve, 0.5" Tube, PVDF, PTFE, Cer	\$ 102.00
33480	Foot Valve, 0.5" Tube, PVDF, PTFE, Cer	\$ 103.00
77384	Connection Kit, 0.5" Tubing	\$ 14.00

Part No.	Metric Connections	Price
Descriptions		
PP Head		
26710	Injection Valve, NPT, PP, PTFE, Cer	\$ 125.00
26015	Foot Valve, NPT, PP, PTFE, Cer	\$ 95.00
PVDF Head		
38270	Injection Valve, NPT, PVDF, PTFE, Cer	\$ 144.00
38271	Foot Valve, NPT, PVDF, PTFE, Cer	\$ 89.00

EXCEL® XR PUMP SELECTION AND PRICING

ACCESSORIES

Tubing Connection Kits (One kit needed per tube end)		
Kit No.	Description	Price
54714	TUBING CONNECTION KIT, 3/8" TUBE	\$ 4.90
54715	TUBING CONNECTION KIT, 1/4"x1/2" HOSE	\$ 4.90
54716	TUBING CONNECTION KIT, 8mm TUBE	\$ 7.20
54717	TUBING CONNECTION KIT, 6x12mm HOSE	\$ 4.90
54718	TUBING CONNECTION KIT, 1/2" TUBE	\$ 7.20
48378	COUPLING NUT	\$ 6.00
10411	COUPLING NUT, 1/2" TUBE	\$ 8.00

Tubing		
Part No.	Description	Price
10342-10	3/8" TUBE X 10 FT	\$ 13.00
10142-10	1/2" TUBE X 10 FT	\$ 15.00
54342-20	1/4"x1/2" HOSE X 20 FT	\$ 80.00
36181-6M	8mm TUBE X 6m	\$ 24.00
70121-6M	6x12mm HOSE X 6m	\$ 32.00

Bulk Kit of 20 Ferrules Each Kit		
Kit No.	Description	Price
54800	BULK FERRULE KIT, 3/8" TUBE	\$ 24.00
54801	BULK FERRULE KIT, 1/4"x1/2" HOSE	\$ 24.00
54802	BULK FERRULE KIT, 8mm TUBE	\$ 60.00
54803	BULK FERRULE KIT, 6x12mm HOSE	\$ 48.00
54804	BULK FERRULE KIT, 1/2" TUBE	\$ 32.00

Input/Output Cordsets			
Part No.	Description	Application Notes	Price
48414	CORDSET, 5 PIN, 2 M / 6.6 FT	(J2) Digital output	\$ 70.00
49035	CORDSET, 6 PIN, 2 M / 6.6 FT	(J1 & J4) Digital input & Analog output	\$ 90.00
54711	CORDSET, 4 PIN, 2 M / 6.6 FT	(J3) Analog input	\$ 65.00
55199	CORDSET, 5 PIN, 2 M / 6.6 FT	(C) ProfiBus/ModBus Communicaton	\$ 120.00

Extension Cable Assembles - 5 Pin		
Part No.	Description	Price
50503-3	Extension Cable, 3 M / 9.8 Ft	\$ 120.00
50503-6	Extension Cable, 6 M / 19.7 Ft	\$ 140.00
50503-15	Extension Cable, 15 M / 49.2 Ft	\$ 240.00
50503-30	Extension Cable, 30 M / 98.4 Ft	\$ 340.00

Extension Cable Assembles - 6 Pin		
Part No.	Description	Price
50684-3	Extension Cable, 3 M / 9.8 Ft	\$ 140.00
50684-6	Extension Cable, 6 M / 19.7 Ft	\$ 180.00
50684-15	Extension Cable, 15 M / 49.2 Ft	\$ 807.00
50684-30	Extension Cable, 30 M / 98.4 Ft	\$ 448.00

Excel® XR METERING PUMP SERIES

PARTS SELECTION and PRICING

Part Number	Description	List Price
10138	BALL	\$ 9.00
10228	SEAT	\$ 13.00
10338	BALL	\$ 4.00
10411	COUPLING NUT	\$ 8.00
10659	BALL	\$ 5.00
25042	BALL	\$ 5.00
25128	SEAT	\$ 15.00
25558	SPRING	\$ 6.00
35326	SEAT	\$ 26.00
35330	SECONDARY DIAPHRAGM	\$ 16.00
36054	SEAT	\$ 5.20
36103	O-RING	\$ 3.00
36116	CARTRIDGE	\$ 3.00
36953	ASSEMBLY, DIAPHRAGM	\$ 176.00
37340	SEAT	\$ 6.00
37341	SPRING	\$ 5.00
48145	SEAT	\$ 5.00
48349	O-RING	\$ 3.00
48378	COUPLING NUT	\$ 6.00
53441	FERRULE, MALE	\$ 36.00
53442	FERRULE, FEMALE	\$ 21.00
70143	FERRULE, MALE	\$ 3.00
70185	FERRULE, MALE	\$ 3.00
70186	FERRULE, FEMALE	\$ 3.00
70187	FERRULE, MALE	\$ 2.30
70188	FERRULE, FEMALE	\$ 3.20
70192	FERRULE, MALE	\$ 3.00
70193	FERRULE, FEMALE	\$ 2.00
77118	ASSEMBLY, DIAPHRAGM	\$ 264.00
77119	ASSEMBLY, DIAPHRAGM	\$ 296.00
0210599016N	FITTING	\$ 190.00
0210696016N	FITTING	\$ 148.00
0920046016N	BALL STOP	\$ 55.00
0920064016N	BALL STOP	\$ 53.00
4070014112N	BALL	\$ 1.00
4370000144N	BALL	\$ 5.00
4370000224N	BALL	\$ 22.00
4370002094N	BALL	\$ 27.00
4370002144N	BALL	\$ 42.00
4370002224N	BALL	\$ 20.00
4380051072N	O-RING	\$ 3.00
4380051162N	O-RING	\$ 1.00

Part Number	Description	List Price
54714	CONN KIT, 3/8" TUBE	\$ 4.90
54715	CONN KIT, 1/4"x1/2" HOSE	\$ 4.90
54716	CONN KIT, 8mm TUBE	\$ 7.20
54717	CONN KIT, 6x12mm HOSE	\$ 4.90
54718	CONN KIT, 1/2" TUBE	\$ 7.20
54800	BULK FERRULE KIT, 3/8" TUBE	\$ 24.00
54801	BULK FERRULE KIT, 1/4"x1/2" HOSE	\$ 24.00
54802	BULK FERRULE KIT, 8mm TUBE	\$ 60.00
54803	BULK FERRULE KIT, 6x12mm HOSE	\$ 48.00
54804	BULK FERRULE KIT, 1/2" TUBE	\$ 32.00
37012	LIQUID END HEAD Size 4 PP	\$ 120.00
70117	LIQUID END HEAD Size 4 PVDF	\$ 452.00
70033	LIQUID END HEAD Size 4 316L ss	\$ 723.00
35031	LIQUID END HEAD Size 4 PP Hi Vis	\$ 218.00
25906	LIQUID END HEAD Size 6 PP	\$ 325.00
48485	LIQUID END HEAD Size 6 PP Hi Vis	\$ 579.00
32234	LIQUID END HEAD Size 6 PVDF	\$ 1,470.00
70034	LIQUID END HEAD Size 6 316L ss	\$ 1,328.00
54195	DISPLAY MEMBRANE	\$ 98.00
52702-1810	CLEAR COVER, DISPLAY	\$ 56.00
52702-1680	BEZEL, DISPLAY	\$ 53.00
48851	CORD, POWER USA 120V, A+	\$ 50.00
48852	CORD, POWER USA 230V, A+	\$ 50.00
48853	CORD, POWER DIN, A+	\$ 57.00
48855	CORD, POWER BRITISH, A+	\$ 50.00
48856	CORD, POWER AUST, A+	\$ 50.00
48857	CORD, POWER SWISS, A+	\$ 45.00
48859	CORD, POWER NO PLUG, A+	\$ 45.00
RPM54771	RPM Size 4 PP/Ceramic Tube Conn	\$ 331.00
RPM54772	RPM Size 4 PP/Ceramic DN15 Conn	\$ 319.00
RPM54773	RPM Size 4 PVDF/Ceramic Tube Conn	\$ 329.00
RPM54774	RPM Size 4 PVDF/Ceramic DN15 Conn	\$ 318.00
RPM54775	RPM Size 4 316 ss Standard	\$ 595.00
RPM54776	RPM Size 4 316 ss Slurry	\$ 687.00
RPM54777	RPM Size 4 PP/316 Ball Hi Vis	\$ 314.00
RPM54778	RPM Size 4 PP/316 Ball Tube Conn	\$ 329.00
RPM54779	RPM Size 4 PP/316 Ball DN15	\$ 318.00
RPM54780	RPM Size 6 Ceramic Ball FKM Seat	\$ 161.00
RPM54781	RPM Size 6 316 ss Standard	\$ 617.00
RPM54782	RPM Size 6 PP Hi Viscosity	\$ 189.00
RPM54783	RPM Size 6 316L ss Ball & Seat Slurry	\$ 664.00
RPM54784	RPM Size 6 316Lss Ball FKM Seat	\$ 158.00

SERIES G SD METERING PUMPS



Size Code	Max Output		Max Pressure	
	GPH	LPH	PSI	Bar
2	0.7	2.6	175	12.1
4	12	45	150	10.3
7	50	189	100	6.9
8	115	435	75	5.2

Liquid Ends & Drives

The liquid ends and drives for Series G pumps can be purchased separately using the codes and pricing from the following price pages.

NOTE: Drives cannot be mixed and matched with all liquid end sizes. Check with factory before attempting to put a different size liquid end on a drive.

SERIES G - SD PUMP SELECTION AND PRICING

SIZE CODE 2

0.7 GPH (2.6 LPH); 175 psi (12 bar)

SD2											Price			
Drive End										Price				
SD2	Size Code										\$	1,576		
Liquid End														
Metallic Head Gear Code														
60Hz						50Hz								
	GPH	LPH	psi	bar	SPM	GPH	LPH	psi	bar	SPM				
1	0.18	0.7	175	12	43	0.15	0.6	175	12	36	\$	-		
2	0.35	1.3	175	12	86	0.29	1.1	175	12	72	\$	-		
6	0.48	1.8	175	12	120	0.4	1.5	175	12	102	\$	-		
3	0.7	2.6	175	12	173	0.58	2.2	175	12	144	\$	-		
Plastic Head Gear Code														
1	0.12	0.5	175	12	43	0.1	0.4	175	12	36	\$	-		
2	0.23	0.9	175	12	86	0.19	0.7	175	12	72	\$	-		
6	0.34	1.3	175	12	120	0.28	1.0	175	12	102	\$	-		
3	0.51	1.9	175	12	173	0.42	1.6	175	12	144	\$	-		
Motor Code														
8	0.25 HP, 1725 RPM, 1 Phase, 60 Hertz, 115/230 Volt, TEFC, NEMA 56C										\$	229		
9	0.33 HP (.25 kW), 1425 RPM, 1 Phase, 50 Hertz, 115/230 Volt, TEFC, NEMA 56C										\$	229		
J	0.25 HP, 1725 RPM, 3 Phase, 60 Hertz, 230/460 Volt, TEFC, NEMA 56C										\$	229		
L	0.33 HP (.25 kW), 1425 RPM, 3 Phase, 50 Hertz, 220/380/440 Volt, TEFC, NEMA 56C										\$	229		
P	DC Variable Speed Drive; 0.5 HP 1725 RPM TEFC motor w/DC Drive, 4-20 mA input, NEMA 4/12 115 VAC										\$	1,833		
X	Mount less Motor; Flange Mount, NEMA 56C										\$	-		
Liquid End Material														
	Head	Valves	Seals	Seats	Balls	RPM								
2	PVDF	PVDF	PVDF	PolyPrel®	C22	Ceramic	RPM099						\$	1,226
8	PVC	PVC	PVDF	PolyPrel®	C22	Ceramic	RPM099						\$	747
7	316 SS	316 SS	316 SS	PTFE	316 SS	316 SS	RPM101						\$	1,727
P	Polymer Apps.	PVC	PVDF	Viton®	Alloy 22	Alloy 20	Call Factory						\$	1,508
N	H2SO4 Apps	PVC	PVDF	PolyPrel®	Alloy 20	Alloy 20	Call Factory						\$	1,518
Connection Code														
P	Standard 1/4" NPTM										\$	-		
T	Tubing (Barb Fitting) 1/4"										Not available on Metallic Heads		\$	-
SD2	1	8	2	P										

RPM	Price	Contents
RPM099	\$ 924.00	
RPM101	\$ 861.00	*Diaphragm *Oil Seal *O-Rings *Suction & Discharge Cartridge, OR *Balls & Seats

All capacities are based on maximum pressures. For operation at reduced pressures, add 1% flow for every 25 psi (1.7 bar) decrease in pressure.

Motor requirements: 1/4 Horsepower or 0.18 KW

SERIES G - SD PUMP SELECTION AND PRICING

SIZE CODE 4

14.4 GPH (55 LPH); 150 psi (10 bar)

SD4										Price		
Drive End												
SD4	Size Code									\$ 1,576		
Liquid End		60Hz					50Hz					
Gear Code	GPH	LPH	psi	bar	SPM	GPH	LPH	psi	bar	SPM		
1	3	11.4	150	10	43	2.5	9.5	150	10	36	\$ -	
2	6.6	25	150	10	86	5.5	21	150	10	72	\$ -	
6	10	38	150	10	120	6.9	26	150	10	102	\$ -	
3	14.4	55	150	10	173	12	45	150	10	144	\$ -	
Motor Code												
8	0.25 HP, 1725 RPM, 1 Phase, 60 Hertz, 115/230 Volt, TEFC, NEMA 56C										\$ 229	
9	0.33 HP (.25 kW), 1425 RPM, 1 Phase, 50 Hertz, 115/230 Volt, TEFC, NEMA 56C										\$ 229	
J	0.25 HP, 1725 RPM, 3 Phase, 60 Hertz, 230/460 Volt, TEFC, NEMA 56C										\$ 229	
L	0.33 HP (.25 kW), 1425 RPM, 3 Phase, 50 Hertz, 220/380/440 Volt, TEFC, NEMA 56C										\$ 229	
P	DC Variable Speed Drive; 0.5 HP 1725 RPM TEFC motor w/DC Drive, 4-20 mA input, NEMA 4/12 115 VAC										\$ 1,833	
X	Mount less Motor; Flange Mount, NEMA 56C										\$ -	
Liquid End Material		Head	Valves	Seals	Seats	Balls	RPM Kit					
2	PVDF	PVDF	PVDF	PolyPrel®	PTFE	Ceramic	RPM102		\$ 1,226			
8	PVC	PVC	PVDF	PolyPrel®	PTFE	Ceramic	RPM102		\$ 747			
7	316 SS	316 SS	316 SS	PTFE	316 SS	316 SS	RPM104		\$ 1,727			
P	Polymer Apps	PVC	PVDF	Viton®	316 SS	316 SS	RPM196		\$ 1,508			
L	Slurry Apps	316 SS	316 SS	-	316 SS	316 SS	RPM212		\$ 2,063			
N	H2SO4 Apps	PVC	PVDF	PolyPrel®	Alloy 20	Alloy 20	RPM173		\$ 1,518			
Connection Code												
P	Standard, 1/4" NPTM (1/2" for Slurry Apps)										\$ -	
T	Tubing (Barb Fitting) 1/4"					Not available on Metallic Heads					\$ -	
P	Degassing, 1/4" NPTF, must order Valve PN 38794					Not available on Metallic Heads					\$ -	
T	Degassing, 1/2" Tubing, must order Valve PN 38794					Not available on Metallic Heads					\$ -	
SD4	1	8	2	P								

RPM Kit	Price	Contents
RPM102	\$ 354.00	*Diaphragm
RPM102	\$ 354.00	*Oil Seal
RPM104	\$ 468.00	*O-Rings
RPM196	\$ 1,243.50	*Suction & Discharge
RPM173	\$ 808.50	Cartridge, OR
RPM212	\$ 1,125.00	*Balls & Seats

Degassing Valve	Price
38794	\$ 220

All capacities are based on maximum pressures. For operation at reduced pressures, add 1% flow for every 25 psi (1.7 bar) decrease in pressure.

Motor requirements: 1/4 Horsepower or 0.18 KW

SERIES G - SD PUMP SELECTION AND PRICING

SIZE CODE 7

50 GPH (189 LPH); 100 psi (7 bar)

SD7										Price										
Drive End										Price										
SD7 Size Code										\$ 1,576										
Liquid End					60Hz					50Hz										
Gear Code	GPH		LPH		psi		bar		SPM		GPH		LPH		psi		bar		SPM	
1	13	49	100	7	43	10	38	100	7	36	\$	-								
2	25	95	100	7	86	21	79	100	7	72	\$	-								
6	34	129	100	7	120	28	106	100	7	102	\$	-								
3	50	189	100	7	173	42	159	100	7	144	\$	-								
Motor Code																				
8 0.25 HP, 1725 RPM, 1 Phase, 60 Hertz, 115/230 Volt, TEFC, NEMA 56C											\$	229								
9 0.33 HP (.25 kW), 1425 RPM, 1 Phase, 50 Hertz, 115/230 Volt, TEFC, NEMA 56C											\$	229								
J 0.25 HP, 1725 RPM, 3 Phase, 60 Hertz, 230/460 Volt, TEFC, NEMA 56C											\$	229								
L 0.33 HP (.25 kW), 1425 RPM, 3 Phase, 50 Hertz, 220/380/440 Volt, TEFC, NEMA 56C											\$	229								
P DC Variable Speed Drive; 0.5 HP 1725 RPM TEFC motor w/DC Drive, 4-20 mA input, NEMA 4/12 115 VAC											\$	1,833								
X Mount less Motor; Flange Mount, NEMA 56C											\$	-								
Liquid End Material		Head		Valves		Seals		Seats		Balls		RPM Kit								
2	PVDF	PVDF	PVDF	PVDF	Teflex®	PVDF	Ceramic	RPM136	\$	2,691										
8	PVC	PVC	PVDF	Viton®	PVC	Ceramic	RPM135	\$	1,223											
7	316 SS	316 SS	316 SS	Viton®	316 SS	316 SS	RPM137	\$	2,877											
P	Polymer Apps	PVC	PVC	Viton®	316 SS	316 SS	RPM211	\$	1,565											
L	Slurry Apps	PVC	316 SS	Viton®	316 SS	316 SS	RPM401	\$	3,060											
N	H2SO4 Apps	PVC	PVDF	PolyPrel®	Alloy 20	Alloy 20	RPM175	\$	2,029											
Connection Code																				
P Standard 1/2" NPTF											\$	-								
T Tubing (Barb Fitting) 1/2"											Not available on Metallic Heads		\$	-						
P Degassing, 1/2" NPTF, must order Valve PN 61411											Not available on Metallic Heads		\$	-						
T Degassing, 1/2" Tubing, must order Valve PN 61411											Not available on Metallic Heads		\$	-						
SD7	1	8	2	P																

RPM Kit	Price	Contents
RPM135	\$ 360.00	*Diaphragm
RPM136	\$ 397.50	*Oil Seal
RPM137	\$ 1,231.50	*O-Rings
RPM211	\$ 825.00	*Suction & Discharge
RPM175	\$ 714.00	Cartridge, OR
RPM401	\$ 1,040.00	*Balls & Seats

Degassing Valve	Price
61411	\$ 1,448

All capacities are based on maximum pressures. For operation at reduced pressures, add 1% flow for every 25 psi (1.7 bar) decrease in pressure.

Motor requirements: 1/4 Horsepower or 0.18 KW

SERIES G - SD PUMP SELECTION AND PRICING

SIZE CODE 8

127 GPH (481 LPH); 75 psi (5 bar)

SD8										Price		
Drive End												
SD8	Size Code									\$ 1,843		
	Liquid End	60Hz					50Hz					
	Gear Code	GPH	LPH	psi	bar	SPM	GPH	LPH	psi	bar	SPM	
	1	31	117	75	5	43	26	98	75	5	36	\$ -
	2	57	216	75	5	86	47	178	75	5	72	\$ -
	6	87	329	75	5	120	72	273	75	5	102	\$ -
	3	127	481	75	5	173	106	401	75	5	144	\$ -
	Motor Code											
	8	0.25 HP, 1725 RPM, 1 Phase, 60 Hertz, 115/230 Volt, TEFC, NEMA 56C									\$ 229	
	9	0.33 HP (.25 kW), 1425 RPM, 1 Phase, 50 Hertz, 115/230 Volt, TEFC, NEMA 56C									\$ 229	
	J	0.25 HP, 1725 RPM, 3 Phase, 60 Hertz, 230/460 Volt, TEFC, NEMA 56C									\$ 229	
	L	0.33 HP (.25 kW), 1425 RPM, 3 Phase, 50 Hertz, 220/380/440 Volt, TEFC, NEMA 56C									\$ 229	
	P	DC Variable Speed Drive; 0.5 HP 1725 RPM TEFC motor w/DC Drive, 4-20 mA input, NEMA 4/12 115 VAC									\$ 1,833	
	X	Mount less Motor; Flange Mount, NEMA 56C									\$ -	
		Liquid End Material	Head	Valves	Seals	Seats	Balls	RPM Kit				
	2	PVDF	PVDF	PVDF	Teflex®	PVDF	Ceramic	RPM106			\$ 2,787	
	8	PVC	PVC	PVDF	Viton®	PVC	Ceramic	RPM105			\$ 1,418	
	7	316 SS	316 SS	316 SS	Viton®	316 SS	316 SS	RPM107			\$ 3,224	
	P	Polymer Apps	PVC	PVC	Viton®	316 SS	316 SS	RPM210			\$ 1,635	
	L	Slurry Apps	PVC	316 SS	Viton®	316 SS	316 SS	Call Factory			\$ 3,311	
	N	H2SO4 Apps	PVC	PVDF	Viton®	Alloy 20	Alloy 20	RPM183			\$ 2,211	
		Connection Code										
	P	Standard 1/2" NPTF									\$ -	
	T	Tubing (Barb Fitting) 1/2"					Not available on Metallic Heads					\$ -
	P	Degassing, 1/2" NPTF, must order Valve PN 61411					Not available on Metallic Heads					\$ -
	T	Degassing, 1/2" Tubing, must order Valve PN 61411					Not available on Metallic Heads					\$ -
SD8	1	8	2	P								

RPM Kit	Price	Contents
RPM105	\$ 360.00	*Diaphragm
RPM106	\$ 355.50	*Oil Seal
RPM107	\$ 1,231.50	*O-Rings
RPM210	\$ 625.50	*Suction & Discharge
RPM183	\$ 736.50	Cartridge, OR *Balls & Seats

Degassing Valve	Price
61411	\$ 1,448

All capacities are based on maximum pressures. For operation at reduced pressures, add 1% flow for every 25 psi (1.7 bar) decrease in pressure.

Motor requirements: 1/4 Horsepower or 0.18 KW

SERIES G - SD PUMP SELECTION AND PRICING

Series G Model SD Drive End

SD					Drive End Only	Price
SD						\$ -
Liquid End Size Code					Max GPH at 173 SPM	
2	Only fits on Liquid End Code 2				0.7	\$ 1,576
4	Liquid End Code 4 & 7 are interchangeable on drives with any of these codes				14.4	\$ 1,576
7	Liquid End Code 4 & 7 are interchangeable on drives with any of these codes				50	\$ 1,576
8	Only fits on Liquid End Code 8				127	\$ 1,843
Gear Code		SPM at 60 Hz	SPM at 50 Hz			
1		43	36			\$ -
2		86	72			\$ -
6		120	102			\$ -
3		173	144			\$ -
Motor Code						
8	0.25 HP, 1725 RPM, 1 Phase, 60 Hertz, 115/230 Volt, TEFC, NEMA 56C					\$ 229
9	0.33 HP (.25 kW), 1425 RPM, 1 Phase, 50 Hertz, 115/230 Volt, TEFC, NEMA 56C					\$ 229
J	0.25 HP, 1725 RPM, 3 Phase, 60 Hertz, 230/460 Volt, TEFC, NEMA 56C					\$ 229
L	0.33 HP (.25 kW), 1425 RPM, 3 Phase, 50 Hertz, 220/380/440 Volt, TEFC, NEMA 56C					\$ 229
P	0.5 HP 1725 RPM TEFC motor w/DC Drive, 4-20 mA Input, NEMA 4/12 115 VAC					\$ 1,833
X	Mount less Motor; Flange Mount, NEMA 56C					\$ -
SD	2	1	8	-DR		

All capacities are based on maximum pressures. For operation at reduced pressures, add 1% flow for every 25 psi (1.7 bar) decrease in pressure.

Motor requirements: 1/4 Horsepower or 0.18 KW

SERIES G - SD PUMP SELECTION AND PRICING

Series G Model SD Liquid End

SD								Price
Liquid End Only								
SD2	Size Code 2							\$ -
SD4	Size Code 4							\$ -
SD7	Size Code 7							\$ -
SD8	Size Code 8							\$ -
Liquid End Material by Size Code								
Size Code 2		Head	Valves	Seals	Seats	Balls	RPM	
2	PVDF	PVDF	PVDF	PolyPrel®	C22	Ceramic	RPM099	\$ 1,226
8	PVC	PVC	PVDF	PolyPrel®	C22	Ceramic	RPM099	\$ 747
7	316 SS	316 SS	316 SS	PTFE	316 SS	316 SS	RPM101	\$ 1,727
P	Polymer Apps.	PVC	PVDF	Viton®	Alloy 22	Alloy 20	Call Factory	\$ 1,508
N	H2SO4 Apps	PVC	PVDF	PolyPrel®	Alloy 20	Alloy 20	Call Factory	\$ 1,518
Size Code 4		Head	Valves	Seals	Seats	Balls	RPM Kit	
2	PVDF	PVDF	PVDF	Teflex®	PVDF	Ceramic	RPM102	\$ 1,226
8	PVC	PVC	PVDF	Viton®	PVC	Ceramic	RPM102	\$ 747
7	316 SS	316 SS	316 SS	Viton®	316 SS	316 SS	RPM104	\$ 1,727
P	Polymer Apps	PVC	PVC	Viton®	316 SS	316 SS	RPM196	\$ 1,508
L	Slurry Apps	PVC	316 SS	Viton®	316 SS	316 SS	RPM212	\$ 2,063
N	H2SO4 Apps	PVC	PVDF	Viton®	Alloy 20	Alloy 20	RPM173	\$ 1,518
Size Code 7		Head	Valves	Seals	Seats	Balls	RPM Kit	
2	PVDF	PVDF	PVDF	Teflex®	PVDF	Ceramic	RPM136	\$ 2,691
8	PVC	PVC	PVDF	Viton®	PVC	Ceramic	RPM135	\$ 1,223
7	316 SS	316 SS	316 SS	Viton®	316 SS	316 SS	RPM137	\$ 2,877
P	Polymer Apps	PVC	PVC	Viton®	316 SS	316 SS	RPM211	\$ 1,565
L	Slurry Apps	PVC	316 SS	Viton®	316 SS	316 SS	RPM401	\$ 3,060
N	H2SO4 Apps	PVC	PVDF	PolyPrel®	Alloy 20	Alloy 20	RPM175	\$ 2,029
Size Code 8		Head	Valves	Seals	Seats	Balls	RPM Kit	
2	PVDF	PVDF	PVDF	Teflex®	PVDF	Ceramic	RPM106	\$ 2,787
8	PVC	PVC	PVDF	Viton®	PVC	Ceramic	RPM105	\$ 1,418
7	316 SS	316 SS	316 SS	Viton®	316 SS	316 SS	RPM107	\$ 3,224
P	Polymer Apps	PVC	PVC	Viton®	316 SS	316 SS	RPM210	\$ 1,635
L	Slurry Apps	PVC	316 SS	Viton®	316 SS	316 SS	Call Factory	\$ 3,311
N	H2SO4 Apps	PVC	PVDF	Viton®	Alloy 20	Alloy 20	RPM183	\$ 2,211
Connections by Size Code								
Size Code 2								
P	Standard 1/4" NPTM							\$ -
T	Tubing (Barb Fitting) 1/4"	Not available on Metallic Heads						\$ -
Size Code 4								
P	Standard, 1/4" NPTM (1/2" for Slurry Apps)							\$ -
T	Tubing (Barb Fitting) 1/4"	Not available on Metallic Heads						\$ -
P	Degassing, 1/4" NPTF, must order Valve PN 38794	Not available on Metallic Heads						\$ -
T	Degassing, 1/2" Tubing, must order Valve PN 38794	Not available on Metallic Heads						\$ -
Size Code 7 & 8								
P	Standard 1/2" NPTF							\$ -
T	Tubing (Barb Fitting) 1/2"	Not available on Metallic Heads						\$ -
P	Degassing, 1/2" NPTF, must order Valve PN 61411	Not available on Metallic Heads						\$ -
T	Degassing, 1/2" Tubing, must order Valve PN 61411	Not available on Metallic Heads						\$ -
SD2	2	P	-LE					

Degassing Valve	Price
38794	\$ 220
61411	\$ 1,448

All capacities are based on maximum pressures. For operation at reduced pressures, add 1% flow for every 25 psi (1.7 bar) decrease in pressure.

Motor requirements: 1/4 Horsepower or 0.18 KW

SERIES G SG METERING PUMPS



Size Code	Max Output		Max Pressure	
	GPH	LPH	PSI	Bar
5	106	400	150	10.3
6	147	556	100	6.9
7	300	1136	50	3.4

Liquid Ends & Drives

The liquid ends and drives for Series G pumps can be purchased separately using the codes and pricing from the following price pages.

NOTE: Drives cannot be mixed and matched with all liquid end sizes. Check with factory before attempting to put a different size liquid end on a drive.

SERIES G - SG PUMP SELECTION AND PRICING

SIZE CODE 5

106 GPH (400 LPH); 150 psi (10.3 bar)

SG5												Price
Drive End											Price	
SG5 Size Code											\$	2,530
Liquid End		60Hz					50Hz					
Gear Code		GPH	LPH	psi	bar	SPM	GPH	LPH	psi	bar	SPM	
1		26	98	150	10.3	43	22	82	150	10.3	36	\$ -
2		53	200	150	10.3	86	44	167	150	10.3	72	\$ -
6		75	284	150	10.3	120	63	237	150	10.3	102	\$ -
3		106	400	150	10.3	173	88	334	150	10.3	144	\$ -
Motor Code												
8	1 HP, 1725 RPM, 1 Phase, 60 Hertz, 115/230 Volt, TEFC, NEMA 56C											\$ 358
9	1 HP (.75 kW), 1425 RPM, 1 Phase, 50 Hertz, 115/230 Volt, TE, NEMA 56C											\$ 358
J	1 hp, 1725 RPM, 3 Phase, 60 Hertz, 230/460 Volt, TEFC, NEMA 56C											\$ 358
L	1 HP (.75 kW), 1450 RPM, 3 Phase, 50 Hertz, 220/380 Volt, TEFC, NEMA 56C											\$ 358
P	1 HP 1725 RPM TEFC motor w/DC Drive, 4-20 mA input, NEMA 4/12 115 VAC											\$ 1,833
X	Mount less Motor; Flange Mount, NEMA 56C											\$ -
Y	Mount less Motor; Flange Mount, NEMA 143/145TC											\$ -
Liquid End Material		Head	Valves	Seals	Seats	Balls	RPM					
2	PVDF	PVDF	PVDF	Teflex®	PVDF	Ceramic	RPM046					\$ 2,467
7	316 SS	316 SS	316 SS	Viton®	316 SS	316 SS	RPM047					\$ 2,948
8	PVC	PVC	PVC	Viton®	PVC	Ceramic	RPM045					\$ 1,280
1	White PP	White PP	PVDF	Viton®	PVC	Ceramic	RPM045					\$ 1,747
C	Caustic Apps	PVC	PVDF	EPDM	PVC	Ceramic	RPM483					\$ 1,280
F	Flouride Apps	PVC	PVDF	Viton®	PVC	PTFE	RPM045					\$ 1,280
P	Polymer Apps	PVC	PVDF	Viton®	316 SS	316 SS	RPM126					\$ 1,722
L	Slurry Apps*	PVC	316 SS	Viton®	316 SS (pin)	316 SS	SEE NOTE					\$ 2,582
N	H2SO4 Apps	PVC	PVDF	Viton®	Alloy 20	Alloy 20	RPM175					\$ 1,860
Connection Code												
P	Standard, 1/2" NPTF											\$ -
T	Tubing (Barb Fitting) 1/2"											\$ -
P	Degassing, 1/2" NPTF, must order Valve PN 61411					Not available on Metallic Heads						\$ -
T	Degassing, 1/2" Tubing, must order Valve PN 61411					Not available on Metallic Heads						\$ -
SG5	1	8	2	P								

RPM	Price	Contents
RPM045	\$ 480.00	
RPM046	\$ 465.00	*Diaphragm
RPM047	\$ 1,419.00	*Oil Seal
RPM126	\$ 960.00	*O-Rings
RPM175	\$ 714.00	*Suction & Discharge Cartridge, OR
RPM226	\$ 1,726.00	*Balls & Seats
RPM400	\$ 1,498.00	
RPM483	\$ 210.00	

Degassing Valve	Price
61411	\$ 1,448

***NOTE:**
 Slurry LE prior to May 2008, use RPM226.
 Slurry LE post May 2008, new, or converted, use RPM400
 SG5 Slurry pumps made before 2008 may require conversion kit RPM226 in order to use parts in RPM400 going forward. RPM400 is a more cost effective design used on all new pumps after May 2008 and on those converted to the new design using RPM226.
 High Viscosity Liquid Ends may result in a reduction of output.
 All Diaphragms are PTFE.
 All capacities are based on maximum pressures. For operation at reduced pressures, add 1% flow for every 25 psi (1.7 bar) decrease in pressure.
 Motor Requirements: 1HP / 0.75kW for Single and Three Phase

SERIES G - SG PUMP SELECTION AND PRICING

SIZE CODE 6

147 GPH (556 LPH); 100 psi (6.9 bar)

SG6											Price		
Drive End										SG6 Size Code	\$ 2,530		
Liquid End		60Hz					50Hz						
Gear Code		GPH	LPH	psi	bar	SPM	GPH	LPH	psi	bar	SPM		
1		36	136	100	6.9	43	30	114	100	6.9	36	\$ -	
2		73	276	100	6.9	86	61	230	100	6.9	72	\$ -	
6		104	394	100	6.9	120	87	238	100	6.9	102	\$ -	
3		147	556	100	6.9	173	123	464	100	6.9	144	\$ -	
Motor Code													
8	1 HP, 1725 RPM, 1 Phase, 60 Hertz, 115/230 Volt, TEFC, NEMA 56C										\$ 358		
9	1 HP (.75 kW), 1425 RPM, 1 Phase, 50 Hertz, 115/230 Volt, TE, NEMA 56C										\$ 358		
J	1 hp, 1725 RPM, 3 Phase, 60 Hertz, 230/460 Volt, TEFC, NEMA 56C										\$ 358		
L	1 HP (.75 kW), 1450 RPM, 3 Phase, 50 Hertz, 220/380 Volt, TEFC, NEMA 56C										\$ 358		
P	1 HP 1725 RPM TEFC motor w/DC Drive, 4-20 ma input, NEMA 4/12 115 VAC										\$ 1,833		
X	Mount less Motor; Flange Mount, NEMA 56C										\$ -		
Y	Mount less Motor; Flange Mount, NEMA 143/145TC										\$ -		
Liquid End Material	Head	Valves	Seals	Seats	Balls	RPM							
2	PVDF	PVDF	PVDF	Teflex®	PVDF	Ceramic	RPM049						\$ 4,272
7	316 SS	316 SS	316 SS	PTFE	316 SS	316 SS	RPM050						\$ 3,225
8	PVC	PVC	PVC	Viton®	PE	Ceramic	RPM048						\$ 1,561
1	White PP	White PP	PP	Viton®	PE	Ceramic	RPM048						\$ 1,952
C	Caustic Apps	PVC	PVC	EPDM	PE	Ceramic	RPM485						\$ 1,561
F	Flouride Apps	PVC	PVC	Viton®	PE	PTFE	RPM048						\$ 1,561
P	Polymer Apps	PVC	PVC	Viton®	316 SS	316 SS	RPM176						\$ 2,486
L	Slurry Apps	PVC	316 SS	Viton®	316 SS (pin)	316 SS	RPM219						\$ 3,271
N	H2SO4 Apps	PVC	PVDF	Viton®	Alloy 20	Alloy 20	RPM194						\$ 2,318
Connection Code													
P	Standard; 1" NPTF for Plastic Heads, 1" NPTM for Metallic Heads										\$ -		
T	Tubing (Barb Fitting) 1"										\$ -		
P	Degassing, 1/2" NPTF, must order Valve PN 61421					Not available on Metallic Heads					\$ -		
T	Degassing, 1/2" Tubing, must order Valve PN 61421					Not available on Metallic Heads					\$ -		
SG6	1	8	2	P									

RPM	Price	Contents
RPM048	\$ 600.00	*Diaphragm
RPM049	\$ 981.00	*Oil Seal
RPM050	\$ 562.50	*O-Rings
RPM176	\$ 1,425.00	*Suction & Discharge
RPM194	\$ 3,165.00	Cartridge, OR
RPM219	\$ 978.00	*Balls & Seats
RPM485	\$ 290.00	

Degassing Valve	Price
61411	\$ 1,448

NOTE:
High Viscosity Liquid Ends may result in a reduction of output.

All Diaphragms are PTFE.

All capacities are based on maximum pressures. For operation at reduced pressures, add 1% flow for every 25 psi (1.7 bar) decrease in pressure.

Motor Requirements: 1HP / 0.75kW for Single and Three Phase

SERIES G - SG PUMP SELECTION AND PRICING

SIZE CODE 7

300 GPH (1136 LPH); 50 psi (3.4 bar)

SG7												Price	
Drive End											SG7	Size Code	\$ 2,656
Liquid End		60Hz					50Hz						
Gear Code		GPH	LPH	psi	bar	SPM	GPH	LPH	psi	bar	SPM		
1		75	284	50	3.4	43	63	237	50	3.4	36	\$ -	
2		149	564	50	3.4	86	127	470	50	3.4	72	\$ -	
6		208	787	50	3.4	120	173	656	50	3.4	102	\$ -	
3		300	1136	50	3.4	173	250	946	50	3.4	144	\$ -	
Motor Code													
8	1 HP, 1725 RPM, 1 Phase, 60 Hertz, 115/230 Volt, TEFC, NEMA 56C											\$ 358	
9	1 HP (.75 kW), 1425 RPM, 1 Phase, 50 Hertz, 115/230 Volt, TE, NEMA 56C											\$ 358	
J	1 hp, 1725 RPM, 3 Phase, 60 Hertz, 230/460 Volt, TEFC, NEMA 56C											\$ 358	
L	1 HP (.75 kW), 1450 RPM, 3 Phase, 50 Hertz, 220/380 Volt, TEFC, NEMA 56C											\$ 358	
P	1 HP 1725 RPM TEFC motor w/DC Drive, 4-20 ma input, NEMA 4/12 115 VAC											\$ 1,833	
X	Mount less Motor; Flange Mount, NEMA 56C											\$ -	
Y	Mount less Motor; Flange Mount, NEMA 143/145TC											\$ -	
Liquid End Material	Head	Valves	Seals	Seats	Balls	RPM							
2	PVDF	PVDF	PVDF	Teflex®	PVDF	Ceramic	RPM052					\$ 6,271	
7	316 SS	316 SS	316 SS	PTFE	316 SS	316 SS	RPM053					\$ 3,988	
8	PVC	PVC	PVC	Viton®	PE	Ceramic	RPM051					\$ 2,913	
C	Caustic Apps	PVC	PVC	EPDM	PE	Ceramic	RPM487					\$ 2,913	
F	Flouride Apps	PVC	PVC	Viton®	PE	PTFE	RPM051					\$ 2,913	
P	Polymer Apps	PVC	PVC	Viton®	316 SS	316 SS	RPM221					\$ 4,053	
L	Slurry Apps	PVC	316 SS	Viton®	316 SS (pin)	316 SS	RPM220					\$ 4,408	
N	H2SO4 Apps	PVC	PVC	Viton®	Alloy 20	Alloy 20	RPM203					\$ 4,344	
Connection Code													
P	Standard; 1" NPTF for Plastic Heads, 1" NPTM for Metallic Heads											\$ -	
T	Tubing (Barb Fitting) 1"											\$ -	
P	Degassing, 1/2" NPTF, must order Valve PN 61421					Not available on Metallic Heads						\$ -	
T	Degassing, 1/2" Tubing, must order Valve PN 61421					Not available on Metallic Heads						\$ -	
SG7	1	8	2	P									

RPM	Price	Contents
RPM051	\$ 630.00	*Diaphragm
RPM052	\$ 1,024.50	*Oil Seal
RPM053	\$ 900.00	*O-Rings
RPM203	\$ 2,700.00	*Suction & Discharge
RPM220	\$ 1,080.00	Cartridge, OR
RPM221	\$ 2,040.00	*Balls & Seats
RPM487	\$ 320.00	

Degassing Valve	Price
61421	\$ 2,097

NOTE:

High Viscosity Liquid Ends may result in a reduction of output.

All Diaphragms are PTFE.

All capacities are based on maximum pressures. For operation at reduced pressures, add 1% flow for every 25 psi (1.7 bar) decrease in pressure.

Motor Requirements-

Single Phase: 1.5 HP / 1.1 kW

Three Phase : 1 HP / 0.75 kW

SERIES G - SG PUMP SELECTION AND PRICING

Series G Model SG Drive End

SG			
Drive End Only			Price
SG	Size Code		\$ 2,530
	Gear Code	SPM at 60 Hz	SPM at 50 Hz
	1	43	36
	2	86	72
	6	120	102
	3	173	144
	Motor Code		
	8	1 HP, 1725 RPM, 1 Phase, 60 Hertz, 115/230 Volt, TEFC, NEMA 56C	
	9	1 HP (.75 kW), 1425 RPM, 1 Phase, 50 Hertz, 115/230 Volt, TE, NEMA 56C	
	J	1 hp, 1725 RPM, 3 Phase, 60 Hertz, 230/460 Volt, TEFC, NEMA 56C	
	L	1 HP (.75 kW), 1450 RPM, 3 Phase, 50 Hertz, 220/380 Volt, TEFC, NEMA 56C	
	P	1 HP 1725 RPM TEFC motor w/DC Drive, 4-20 ma input, NEMA 4/12 115 VAC	
	X	Mount less Motor; Flange Mount, NEMA 56C	
	Y	Mount less Motor; Flange Mount, NEMA 143/145TC	
SG	1	8	-DR

SERIES G - SG PUMP SELECTION AND PRICING

Series G Model SG Liquid End

SG		Liquid End Only							Price
SG5	Size Code 5								\$ -
SG6	Size Code 6								\$ -
SG7	Size Code 7								\$ -
Liquid End Material by Size Code									
Size Code 5		Head	Valves	Seals	Seats	Balls	RPM		
2	PVDF	PVDF	PVDF	Teflex®	PVDF	Ceramic	RPM046	\$ 2,467	
7	316 SS	316 SS	316 SS	Viton®	316 SS	316 SS	RPM047	\$ 2,948	
8	PVC	PVC	PVC	Viton®	PVC	Ceramic	RPM045	\$ 1,280	
1	White PP	White PP	PVDF	Viton®	PVC	Ceramic	RPM045	\$ 1,747	
C	Caustic Apps	PVC	PVDF	EPDM	PVC	Ceramic	RPM483	\$ 1,280	
F	Flouride Apps	PVC	PVDF	Viton®	PVC	PTFE	RPM045	\$ 1,280	
P	Polymer Apps	PVC	PVDF	Viton®	316 SS	316 SS	RPM126	\$ 1,722	
L	Slurry Apps	PVC	316 SS	Viton®	316 SS (pin)	316 SS	see note	\$ 2,582	
N	H2SO4 Apps	PVC	PVDF	Viton®	Alloy 20	Alloy 20	RPM175	\$ 1,860	
Size Code 6		Head	Valves	Seals	Seats	Balls	RPM		
2	PVDF	PVDF	PVDF	Teflex®	PVDF	Ceramic	RPM049	\$ 4,272	
7	316 SS	316 SS	316 SS	PTFE	316 SS	316 SS	RPM050	\$ 3,225	
8	PVC	PVC	PVC	Viton®	PE	Ceramic	RPM048	\$ 1,561	
1	White PP	White PP	PP	Viton®	PE	Ceramic	RPM048	\$ 1,952	
C	Caustic Apps	PVC	PVC	EPDM	PE	Ceramic	RPM485	\$ 1,561	
F	Flouride Apps	PVC	PVC	Viton®	PE	PTFE	RPM048	\$ 1,561	
P	Polymer Apps	PVC	PVC	Viton®	316 SS	316 SS	RPM176	\$ 2,486	
L	Slurry Apps	PVC	316 SS	Viton®	316 SS (pin)	316 SS	RPM219	\$ 3,271	
N	H2SO4 Apps	PVC	PVDF	Viton®	Alloy 20	Alloy 20	RPM194	\$ 2,318	
Size Code 7		Head	Valves	Seals	Seats	Balls	RPM		
2	PVDF	PVDF	PVDF	Teflex®	PVDF	Ceramic	RPM052	\$ 6,271	
7	316 SS	316 SS	316 SS	PTFE	316 SS	316 SS	RPM053	\$ 3,988	
8	PVC	PVC	PVC	Viton®	PE	Ceramic	RPM051	\$ 2,913	
C	Caustic Apps	PVC	PVC	EPDM	PE	Ceramic	RPM487	\$ 2,913	
F	Flouride Apps	PVC	PVC	Viton®	PE	PTFE	RPM051	\$ 2,913	
P	Polymer Apps	PVC	PVC	Viton®	316 SS	316 SS	RPM221	\$ 4,053	
L	Slurry Apps	PVC	316 SS	Viton®	316 SS (pin)	316 SS	RPM220	\$ 4,408	
N	H2SO4 Apps	PVC	PVC	Viton®	Alloy 20	Alloy 20	RPM203	\$ 4,344	
Connections by Size Code									
Size Code 5									
P	Standard, 1/2" NPTF								\$ -
T	Tubing (Barb Fitting) 1/2"								\$ -
P	Degassing, 1/2" NPTF, must order Valve PN 61411					Not available on Metallic Heads			\$ -
T	Degassing, 1/2" Tubing, must order Valve PN 61411					Not available on Metallic Heads			\$ -
Size Code 6 & 7									
P	Standard; 1" NPTF for Plastic Heads, 1" NPTM for Metallic Heads								\$ -
T	Tubing (Barb Fitting) 1"								\$ -
P	Degassing, 1/2" NPTF, must order Valve PN 61421					Not available on Metallic Heads			\$ -
T	Degassing, 1/2" Tubing, must order Valve PN 61421					Not available on Metallic Heads			\$ -
SG5	2	P	-LE						

Degassing Valve	Price
61411	\$ 1,448
61421	\$ 2,097

SERIES G PARTS

Part Number	Description	Units	Price	Part Number	Description	Units	Price
21291	DRIVE SHAFT MACROY D	EA	\$ 571.50	60443	SIDE COVR OBSOLETE USE H60767	EA	Obsolete
39461	CARTRIDGE ASM, .375	EA	\$ 570.00	60444	STROKE ADJ (H60768)INS OBSOLETE	EA	Obsolete
40203	WALDES TRUARC RET RING 5133-12	EA	\$ 11.18	60536	HEAD ACRYLIC GB40	EA	\$ 1,462.50
40204	WALDES RET RING X5133-18	EA	\$ 11.18	60618	DIAPHRAGM D82 LE 40 GYLON	EA	\$ 196.50
40348	O-RING TEFLX PARKER#2-117	EA	Obsolete	60624	DIAPHRAGM GB60 GYLON	EA	\$ 196.50
41065	BREATHER PLUG, 3/8 (#54022)	EA	\$ 52.50	60628	DIAPHRAGM CAP GB40 PVC	EA	\$ 141.00
41069	SOC HD SCR #10-24X1-3/4 SS	EA	\$ 11.18	60629	DIAPHRAGM CAP GB40 POLYPRO	EA	\$ 210.00
41655	BALL 9/32 DIA. CA20	EA	\$ 78.00	60630	DIAPHRAGM CAP GB40 PVDF	EA	\$ 294.00
41892	DC Variable Speed Drive for G Series	EA	\$ 877.50	60631	DIAPHRAGM CAP GB40 316SS	EA	\$ 375.00
60001	DRIVE HOUSING MACHINED GB	EA	\$ 741.00	60632	SUPPORT NUT GB40 304SS	EA	\$ 247.50
60002	SLIDING CRANK STEEL GB	EA	\$ 345.00	60633	DIAPHRAGM CAP GB60 PVC	EA	\$ 118.50
60003	ECCENTRIC STEEL GB	EA	\$ 300.00	60634	DIAPHRAGM CAP GB60 POLYPRO	EA	\$ 148.50
60007	GEAR 10:1 (USE S60007)	EA	Obsolete	60635	DIAPHRAGM CAP GB60 PVDF	EA	\$ 991.50
60009	GEAR 20:1 MACD(SEE S60009)	EA	Obsolete	60636	DIAPHRAGM CAP GB60 316SS	EA	\$ 495.00
60011	GEAR 40:1 MACG(SEE S60011)	EA	Obsolete	60637	SUPPORT NUT GB60 304SS	EA	\$ 301.50
60014	THRUST FLANGE BEARING GB	EA	\$ 103.50	60638	DIAPH CAP GB80 PVC (60170)	EA	\$ 367.50
60020	WORM 40:1 F130 GB	EA	Consult	60639	DIAPH CAP GB80 POLYPRO (60160)	EA	\$ 1,989.00
60024	CARTRIDGE BODY PVDF GB40	EA	\$ 46.05	60640	DIAPHRAGM CAP GB80 PVDF	EA	\$ 1,296.00
60031	HEAD PVDF GB40	EA	\$ 2,479.50	60642	SUPPORT NUT GB80 304SS	EA	\$ 1,042.50
60032	HEAD POLYPRO GB40	EA	\$ 264.00	60654	OBSOLETE - SEE S60654	EA	Consult
60033	HEAD PVC GB40	EA	\$ 394.50	60733	COUPLING WORM,GM/MACROY D, 56C	EA	\$ 33.00
60034	OIL SEAL CLAMP ALUM G	EA	\$ 38.10	60754	BACK-UP PLATE G40/60	EA	\$ 195.00
60035	DIAPH SUPPORT RING GB40 POLYP	EA	\$ 90.00	60765	O-RING, TEFLX-V-123	EA	\$ 29.40
60043	OIL SEAL CLAMP ALUM G	EA	\$ 22.50	60819	G40 LIME SLURRY,SEAL RING,316S	EA	\$ 475.50
60048	DIAPHRAGM / OIL SEAL BELLOWS	EA	\$ 23.70	60828	DO NOT USE (S60829&S60829)	EA	Obsolete
60050	GEAR OBSOLETE - SEE S60050	EA	Obsolete	60829	DO NOT USE (S60829&S60829)	EA	Obsolete
60052	SHOE GB	EA	\$ 45.00	60855	SEAT 5/8"BALL CA20	EA	\$ 223.50
60068	HEAD PVDF GB60	EA	\$ 2,068.50	60865	CONV KIT D7,D8,G5 POLYMER 1/2"	EA	\$ 997.50
60070	DIAPHRAGM SUPPORT RING GB60	EA	\$ 93.00	60875	ECCENTRIC; STROKE COUNTING	EA	\$ 2,137.50
60086	HEX HEAD PLUG 3/8-19 BSP	EA	\$ 63.00	60876	TARGET; MACG STROKE COUNTING	EA	\$ 951.00
60117	UNION END 1/2 NPT FEMALE PVC	EA	\$ 39.00	60877	HOUSING; STROKE COUNTING	EA	\$ 1,474.50
60119	UNION END 1/2 NPT PVDF	EA	\$ 81.00	60878	INDUCTIVE PROXIMITY SWITCH	EA	\$ 1,366.50
60130	HEAD PVC GB60	EA	\$ 421.50	60931	BASE KIT MACROY	EA	\$ 57.00
60132	UNION END 1" NPT PVC	EA	\$ 35.85	60948	STRK ADJ SCR G OBSOL(H60768)	EA	Consult
60133	UNION END 1" NPT PVDF	EA	\$ 159.00	60949	BRG RET OBSOL(H60757)	EA	Obsolete
60135	COUPLING 1 BSP X 1/2 NPT 316	EA	\$ 315.00	60973	HSG STROKE COUNTING SPECIAL G	EA	\$ 1,947.00
60147	UNION END 1" BSP PVDF	EA	\$ 451.50	60974	TARGET ADAPTER STR COUNTING	EA	\$ 2,914.50
60148	CAUTION MOTOR DECAL G	EA	\$ 15.00	60995	DIAPHRAGM, MACROY D, LE4	EA	\$ 196.50
60150	DIAPHRAGM ASSY GB40 PVC	EA	\$ 777.00	61035	SPACER: MACROY D LE 2/4	EA	\$ 378.00
60151	DIAPHRAGM ASSY GB60 PVC	EA	\$ 1,252.50	61051	SUPPORT NUT: MACD4.0	EA	\$ 282.00
60159	DIAPHRAGM SUPPORT RING GB80	EA	\$ 307.50	61052	DIAPHRAGM CAP; PVC; MACD4.0	EA	\$ 196.50
60160	CAP POLYPRO B80 (60639)	EA	Obsolete	61053	DIAPHRAGM CAP; PVDF; MACD4.0	EA	\$ 261.00
60162	DIAPHRAGM GB80 GYLON	EA	\$ 264.00	61055	PTFE WASHER	EA	\$ 13.16
60163	SUPPORT NUT ALUM GB80 (60642)	EA	Consult	61056	PVC HEAD	EA	\$ 556.50
60165	ADAPTER LE/HSG ALUM GB80	EA	\$ 457.50	61059	10-24X 3/4" HI-PREFORM HEXHEAD	EA	\$ 9.57
60171	HEAD PVC GB80	EA	\$ 1,051.50	61075	SUPPORT RING MACROY D 4	EA	\$ 109.50
60173	DIAPH CAP PVDF GB80 (60640)	EA	\$ 718.50	61076	MAC D & MIL D NAMEPLTE	EA	\$ 26.10
60174	HEAD PVDF GB80	EA	\$ 5,952.00	61083	ADAPTER; MACD2.0	EA	\$ 387.00
60180	DIAPHRAGM HEAD 316 GB80	EA	\$ 2,697.00	61088	DIAPHRAM SEAT RING	EA	\$ 400.50
60199	MOTOR ADAPTER PLATE IEC 80	EA	\$ 307.50	61089	DIAPHRAGM HEAD PVC SD2	EA	\$ 855.00
60206	HEX HD SCR M8X130MM LG 304SS	EA	\$ 28.50	61090	DIAPHRAGM HEAD PVDF SD2	EA	\$ 976.50
60208	HEX NIPPLE 1/4NPT X 1/4BSP 316	EA	\$ 78.00	61104	MALE ECCENTRIC SD2	EA	\$ 681.00
60222	WORM-GEAR-SHAFT 10:1 IEC80	EA	\$ 811.50	61105	FEMALE ECCENTRIC SD2	EA	\$ 628.50
60223	WORM-GEAR-SHAFT 20:1 IEC 80	EA	\$ 811.50	61106	DIAPHRAGM HEAD 316SS SD2	EA	\$ 1,315.50
60224	WORM-GEAR-SHAFT 40:1 IEC80	EA	\$ 811.50	61107	BALL SEAT 9/32 BALL	EA	\$ 381.00
60226	DIAPHRAGM ASSY GB80 PVC	EA	\$ 1,483.50	61108	KEY SD2	EA	\$ 309.00
60227	DIAPHRAGM ASSY GB80 POLYPRO	EA	\$ 1,108.50	61114	COUPLING IEC 71 FR MAC D	EA	\$ 475.50
60228	DIAPHRAGM ASSY GB80 316SS	EA	\$ 2,041.50	61115	COUPLING 56CFR MAC D	EA	\$ 1,539.00
60229	DIAPHRAGM ASSY GB80 PVDF	EA	\$ 1,381.50	61116	BEARING DEEP GROOVE SKF# 6203	EA	\$ 35.40
60232	D.D. SPACER PVC GB80	EA	\$ 1,963.50	61118	G60-80 SLURRY VALVE BODY,316	EA	\$ 1,617.00
60233	D.D. INTER RING PVC GB80	EA	\$ 2,158.50	61136	COVER MACHINED SD	EA	\$ 1,702.50
60260	WORM SHAFT COUPLING IEC 71 FR	EA	\$ 90.00	61141	CHECK VALVE SD2-PVC/PVDF-NPT	EA	\$ 868.50
60261	WORM SHAFT COUPLING 56C FR	EA	\$ 90.00	61142	CHECK VALVE SD2-PVC/PVDF-TUBE	EA	\$ 892.50
60264	SPRING LEE LC-092H-1	EA	\$ 10.92	61145	SUPPORT RING, SD8	EA	\$ 672.00
60266	CHECK 1/2NPTF CERAMIC BALL	EA	Obsolete	61146	SUPPORT NUT; D8	EA	\$ 409.50
60292	SIDE GUARDS ECC GB MODIFY	EA	\$ 387.00	61147	HEAD PVDF SD8	EA	\$ 1,123.50
60294	PAN HD SCR SLOT M3X10MM 304SS	EA	\$ 9.57	61148	HEAD PVC SD8	EA	\$ 433.50
60296	STROKE CONTROL KNOB KIT	EA	\$ 81.00	61149	HEAD 316SS SD8	EA	\$ 2,040.00
60395	WORM-GEAR-SHAFT 10:1 56C	EA	\$ 811.50	61152	SPACER: MACROY D7/8	EA	\$ 15.00
60396	WORM-GEAR-SHAFT 20:1 56C	EA	\$ 811.50	61153	SPRING CUP D7/8 (6)	EA	\$ 57.00
60397	WORM-GEAR-SHAFT 40:1 56C"G"	EA	\$ 811.50	61154	PTFE SEAL RING	EA	\$ 30.00

SERIES G PARTS

Part Number	Description	Units	Price	Part Number	Description	Units	Price
61155	ADAPTER, CONN. ROD, SD7/8	EA	\$ 45.00	980358062	SUPPORT NUT D82 LE 40	EA	\$ 118.50
61156	LE ADPTR, SD7/8(D61156/H5IS)	EA	\$ 366.00	980366071	D.D. INTER RING PVC GB40	EA	\$ 448.50
61216	SEAT CA20 1" BALL, MACROY G	EA	\$ 501.00	980367071	D.D. SPACER PVC GB40	EA	\$ 448.50
61246	STANDOFF - D/SD ECC	EA	\$ 237.00	980368071	D.D. INTER RING PVC GB60	EA	\$ 2,565.00
61247	DRIVE COUPLING - D/SD ECC	EA	\$ 450.00	980369071	D.D. SPACER PVC GB60	EA	\$ 2,208.00
61260	HEAD BLEED PORT 316 GB40	EA	\$ 1,509.00	2240173078	SEAT 5/8 PVDF	EA	\$ 38.55
61261	STROKE SCREW, ORING, MACROY D	EA	\$ 1,572.00	2530046062	STROKE SCALE	EA	\$ 15.00
61262	SET SCREW M8 MOD, 3"MACROY D	EA	\$ 79.50	3050583022	CHECK VALVE D25 ASSY 316SS	EA	\$ 688.50
61266	BASE MACROY G AND D	EA	\$ 165.00	3050629007	COMP BODY/SEAT/ORING/BALL	EA	\$ 597.00
61270	SEAT 3/8 BALL MACROY D-4, D-2	EA	\$ 334.50	3050629008	CHECK VALVE D25 ASSY PVDF	EA	\$ 2,040.00
61273	CHECK VLV SD4-PVC/PVDF-NPT DIS	EA	\$ 694.50	3050629009	COMP BODY/SEAT/ORING/BALL	EA	\$ 919.50
61274	CHECK VLV SD4-PVC/PVDF-NPT SUC	EA	\$ 387.00	3050629500	SEAT, BALL, SEAL KIT - G6/7	EA	\$ 283.50
61275	SPRING, LEE LC-016C-8-HAST-C	EA	\$ 438.00	3050629700	SEAT, O-RING, BALL D25 PVDF	EA	\$ 1,167.00
61277	CHKVLVS SLURRY G6,7 KIT	EA	\$ 3,988.50	3050870007	CHK VALVE DN 15 PVC	EA	\$ 277.50
61300	INDUCTIVE SWITCH CABLE	EA	\$ 139.50	3050870008	CHECK VALVE D15.9 ASSY PVDF	EA	\$ 303.00
61302	VALVE BODY & GUIDE D15.9 316L	EA	\$ 549.00	3050876602	SS CHK VALV USE IN HSE COMPON	EA	\$ 639.00
61303	COUPLING 1 BSP X 3/4 NPT 316	EA	\$ 673.50	3050879500	SEAT, BALL & O-RING KIT GB	EA	\$ 190.50
61304	SUC CHECK ASSY G6 316 KIT	EA	\$ 1,591.50	3050879700	SEAT, O-RING, BALL D15.9 PVDF	EA	\$ 207.00
61305	HEAD BLEED PORT PVC GB40	EA	\$ 586.50	3050976090	DIAPHRAGM ASSY GB60 POLYPRO	EA	\$ 619.50
61306	HEAD BLEED PORT POLY PRO GB40	EA	\$ 741.00	3050976110	DIAPHRAGM ASSY G5 POLYPRO	EA	\$ 619.50
61307	HEAD BLEED PORT PVDF GB40	EA	\$ 1,536.00	3050976120	DIAPHRAGM ASSY GB40 316	EA	\$ 720.00
61316	BALL SEAT 3/8 BALL CA-20	EA	\$ 303.00	3050976130	DIAPHRAGM ASSY GB40 PVDF	EA	\$ 793.50
61319	HEX HD SCR M8X140MM LG 304SS	EA	\$ 11.18	3050976230	DIAPHRAGM ASSY GB60 PVDF	EA	\$ 714.00
61377	DIAPHRAGM HEAD BLK POLY SD2	EA	\$ 775.50	3050976320	DIAPHRAGM ASSY GB60 316	EA	\$ 805.50
61378	MALE CONN 1/16 NPTM X1/8 TUBE	EA	Obsolete	4040009012	FLAT WASHER 3/8 Z PLT	EA	\$ 9.57
61379	MODIFY STUD 1/4 X 1-3/8LG	EA	\$ 267.00	4040107231	TRUARC RET RING 5160-66 - N/A	EA	\$ 9.57
61380	ADAPTER DOUBLE DIAPH MACD2.0	EA	\$ 760.50	4050018119	HEX HD SCR 3/8-16X1 GR5 ULTRA	EA	\$ 12.26
61381	DIAPH MACROY D2 MODIFY DD	EA	\$ 303.00	4070014172	BALL 5/8 316SS	EA	\$ 48.15
61386	DIAPHRAM SEAT RING DD	EA	\$ 936.00	4070014173	BALL, 5/8 CA20	EA	\$ 121.50
61395	ELBOW 1" MPT X 1" BARB PVDF	EA	\$ 72.00	4070014233	BALL 1" CA20	EA	\$ 307.50
61396	ELBOW 1/2" MPT X 1/2" BARB PVDF	EA	\$ 39.00	4070152010	GEAR OIL EP-95, QUART CAN	QT	\$ 24.60
61407	DE-GASSING VALVE BODY PVC	EA	\$ 621.00	4070324030	SD GEAR OIL	QT	\$ 58.50
61408	DE-GASSING SEAT INSERT PVC	EA	\$ 381.00	4080068135	O-RING 2-123 VITON A	EA	\$ 14.84
61409	DE-GASSING BALL STOP PVC	EA	\$ 142.50	4080095371	O-RING PARKER 2-246 BUNA N	EA	\$ 14.84
61410	DE-GASSING LIFT PIN HASTC22	EA	\$ 195.00	4090116040	BEARING CONE - TIMKEN LM11949	EA	\$ 37.50
61411	DE-GAS VAL ASY PVC D7/D8/G5	EA	\$ 1,447.50	4090116050	BEARING CUP - TIMKEN LM11910	EA	\$ 20.22
61412	UNION END 1/4 NPTF PVC	EA	\$ 78.00	4099994000	BEARING SINGLE ROW SKF# 6303 - N/A	EA	\$ 186.00
61413	'O' RING 2-015 VITON	EA	Obsolete	4320236038	UNION NUT 1/2" PVC	EA	\$ 26.40
61414	DE-GASSING ADAP PVC 1" BSP	EA	\$ 933.00	4320236058	UNION NUT 1" PVC	EA	\$ 33.90
61415	WORM-GEAR-SHAFT 14:1 56C	EA	\$ 862.50	4320350008	UNION END METRIC SOC 25X32PVC	EA	\$ 23.25
61421	DEGASSING VALVE	EA	\$ 2,097.00	4320350028	UNION END METRIC SOC 15X20PVC	EA	\$ 15.00
61422	SENSOR ADAPTER STR COUNTING	EA	\$ 472.50	4340009002	SPRING LOCKWASHER 8MM SS	EA	\$ 9.57
61425	DE-GASSING ADAP PVC 1-1/2 BSP	EA	\$ 1,102.50	4340009095	SPRING LOCKWASHER 12MM 18-8SS	EA	\$ 9.57
61426	HEAD BLEED PORT PVC GB60	EA	\$ 793.50	4340055073	FLAT WASHER M12 REG 304SS	EA	\$ 9.57
61439	SEAT 9/32 BALL CA20	EA	\$ 381.00	4350000042	HEX NUT M8 CLASS 8 STAINLESS S	EA	\$ 9.57
62000	BASE MACROY D 3-A	EA	\$ 822.00	4350001622	HEX HD SCR M8X 16MM LG Z PL	EA	\$ 9.57
62001	DRIVE HOUSING MACHINED FD	EA	\$ 720.00	4350001655	HEX HD SCR M8-1.25X110 304SS	EA	\$ 12.26
62002	LOCKING KNOB MACROY FD 316	EA	\$ 472.50	4350001732	HEX HD SCR M10 X 25MM STL	EA	\$ 9.57
62003	STROKE KNOB MACROY FD 316SS	EA	\$ 1,306.50	4350003473	SOC HD SCR M8 X 25MM ZINC PLT	EA	\$ 9.57
62009	STROKE SCREW COVER WORK	EA	\$ 384.00	4350035542	HEX HD SCR M8 X 35MM Z PL	EA	Obsolete
62013	DIAPHRAGM CAP 40 316SS 3A PUMP	EA	\$ 1,072.50	4350035655	HEX HD SCR M8X 90MM LG 304SS	EA	\$ 16.94
62014	LE ADAPTOR, SD7/8, 3A PUMP	EA	\$ 2,109.00	4350035785	HEX HD SCR M10 X 75MM LG 304	EA	\$ 23.25
62019	BALL GUIDE 5/8 WITH 1" T/C	EA	\$ 1,648.50	4350036035	HEX HD SCR M12 X 130MM 304SS	EA	\$ 28.20
62020	SEAT 5/8 BALL WITH 1" T/C	EA	\$ 520.50	4350071284	SOC SET SCR DOG PT M10X45MM ST	EA	\$ 10.47
62021	LIQUID END SD 7/8 3-A	EA	\$ 2,953.50	4350071334	SOC SET SCR DOG PT M10X70MM ST	EA	\$ 15.00
70003	MOLDED CONNECTING ROD DMR PART-N/A	EA	\$ 112.50	4350071374	SOC SET SCR CUP PT M10X90MM	EA	\$ 24.00
70022	G KNOB STICKER(SEE69004)	EA	Obsolete	4350117100	SELF-TAPPING TH'D INSERT M10	EA	\$ 11.82
70066	STROKE ADJUST KNOB GB	EA	\$ 57.00	4370000140	BALL 14MM CERAMIC AD995	EA	\$ 97.50
70067	VENT W/DIP STICK	EA	\$ 69.00	4370000169	BALL D15.9 GLASS (BOROSILICATE)	EA	\$ 47.55
40215010	VALVE CLAMP 304SS	EA	\$ 375.00	4380051062	O-RING VITON	EA	Consult
210696016	VAL BODY & GUIDE (REWORK)	EA	\$ 436.50	60030106071	BALL GUIDE PVC	EA	\$ 213.00
210696071	CARTRIDGE BODY DOUBLE B40 PVC	EA	\$ 261.00	60240137073	SEAT POLYETHYLENE 1" BALL	EA	\$ 124.50
210760016	HEAD 316 GB40	EA	\$ 4,410.00	1600273192N	MALE ECCENTRIC 6MM S.L. - N/A	EA	Obsolete
210761016	HEAD 316 GB60	EA	\$ 2,779.50	2502110067N	SEAL SIDE COVER SD	EA	\$ 54.00
240137016	SEAT, 1" BALL, 316SS	EA	\$ 987.00	3701310039N	OBSOLETED SEE 37013100039	EA	Obsolete
440090078	POPPET, PVDF	EA	\$ 159.00	4380024051N	O-RING 102MM ID 4MM THICK	EA	\$ 30.90
450128116	CHECK VALVE BODY 1" NPT 316	EA	\$ 246.00	5203092085N	GEAR 10:1 MACROY D - N/A Must purchase Drive	EA	Obsolete
450420016	COUPLING 1 BSP X 1/2 BSP 316	EA	\$ 237.00	5203093085N	GEAR 20:1 MACROY D - N/A Must purchase Drive	EA	Obsolete
800123026	SPRING, HASTELLOY C	EA	\$ 65.25	5203094085N	GEAR 40:1 MACROY D - N/A Must purchase Drive	EA	Obsolete
920064071	BALL STOP B40 PVC	EA	\$ 148.50	H60767	SIDE COVER GB	EA	\$ 465.00

SERIES G PARTS

Part Number	Description	Units	Price
H60768	ADJUST SCREW GB	EA	\$ 135.00
RPM019	ROUTINE MAINT KIT GB40 POLYPRO	EA	\$ 720.00
RPM020	ROUTINE MAINT KIT GB60 POLYPRO	EA	\$ 1,425.00
RPM021	ROUTINE MAINT KIT GB80 POLYPRO	EA	\$ 1,470.00
RPM022	ROUTINE MAINT KIT GB40 PVC	EA	\$ 637.50
RPM023	ROUTINE MAINT KIT GB60 PVC	EA	\$ 1,087.50
RPM024	ROUTINE MAINT KIT GB80 PVC	EA	\$ 1,335.00
RPM025	ROUTINE MAINT KIT GB40 PVDF	EA	\$ 915.00
RPM026	ROUTINE MAINT KIT GB60 PVDF	EA	\$ 1,564.50
RPM027	ROUTINE MAINT KIT GB80 PVDF	EA	\$ 2,835.00
RPM028	ROUTINE MAINT KIT GB40 G5 316	EA	\$ 1,845.00
RPM029	ROUTINE MAINT KIT GB60 316SS	EA	\$ 945.00
RPM030	ROUTINE MAINT KIT GB80 316SS	EA	\$ 1,470.00
RPM045	RPM KIT G5 SG5 PP/PVC/ACRYLIC	EA	\$ 480.00
RPM046	RPM KIT G5 SG5 PVDF	EA	\$ 465.00
RPM047	RPM KIT G5 SG5 316SS	EA	\$ 1,419.00
RPM048	RPM KIT G6 SG6 PP/PVC/ACRYLIC	EA	\$ 600.00
RPM049	RPM KIT G6 SG6 PVDF	EA	\$ 981.00
RPM050	RPM KIT G6 SG6 316SS	EA	\$ 562.50
RPM051	RPM KIT G7 SG7 PP/PVC/ACRYLIC	EA	\$ 630.00
RPM052	RPM KIT G7 SG7 PVDF	EA	\$ 1,024.50
RPM053	RPM KIT G7 SG7 316SS	EA	\$ 900.00
RPM099	RPM KIT D2/SD2 PVC / PVDF	EA	\$ 924.00
RPM101	RPM KIT D2/SD2 316SS	EA	\$ 861.00
RPM102	RPM KIT D4/SD4 PVC / PVDF	EA	\$ 354.00
RPM104	RPM KIT D4/SD4 316SS	EA	\$ 468.00
RPM105	RPM KIT D8/SD8 PVC	EA	\$ 360.00
RPM106	RPM KIT D8/SD8 PVDF	EA	\$ 355.50
RPM107	RPM KIT D8/SD8 316SS	EA	\$ 1,231.50
RPM126	RPM KIT G5 SG5 POLYMER CHKVLVS	EA	\$ 960.00
RPM134	RPM KIT G51X0002	EA	\$ 1,212.00
RPM135	RPM KIT D7/SD7 PVC	EA	\$ 360.00
RPM136	RPM KIT D7/SD7 PVDF	EA	\$ 397.50
RPM137	RPM KIT D7/SD7 316SS	EA	\$ 1,231.50
RPM161	RPM KIT D2/SD2 PVC / PVDF D.D.	EA	\$ 1,236.00
RPM162	RPM KIT D2/SD2 316SS D.D.	EA	\$ 1,171.50
RPM163	RPM KIT D4/SD4 PVC / PVDF D.D.	EA	\$ 489.00
RPM164	RPM KIT D4/SD4 316SS D.D.	EA	\$ 612.00
RPM173	RPM KIT D4 H2SO4 NPT CONN	EA	\$ 808.50
RPM174	RPM KIT D4 H2SO4 TUBING CONN	EA	\$ 813.00
RPM175	RPM KIT G5 D7 SG5 SD7 H2SO4	EA	\$ 714.00
RPM176	RPM KIT G6 SG6 POLYMER CHKVLVS	EA	\$ 1,425.00
RPM178	ROUTINE MAINT KIT SD71X0001	EA	\$ 1,981.50
RPM183	RPM KIT D8 H2SO4	EA	\$ 736.50
RPM185	RPM KIT FD7 SEAT,BALL,GASKET	EA	\$ 811.50
RPM194	RPM KIT G6 SG6 H2SO4	EA	\$ 3,165.00
RPM196	RPM KIT SD4 & SD2 POLYMER	EA	\$ 1,243.50
RPM203	RPM KIT G7 H2SO4	EA	\$ 2,700.00
RPM210	RPM KIT D8/SD8 POLYMER	EA	\$ 625.50
RPM211	RPM KIT D7/SD7 POLYMER	EA	\$ 825.00
RPM212	RPM KIT D4/SD4 SLURRY	EA	\$ 1,125.00
RPM219	RPM KIT G6 SG6 316SS SLURRY	EA	\$ 978.00
RPM220	RPM KIT G7 SG7 316SS SLURRY	EA	\$ 1,080.00
RPM221	RPM KIT G7 SG7 POLYMER CHKVLVS	EA	\$ 2,040.00
S60654	CONNECTING ROD GB	EA	\$ 145.23

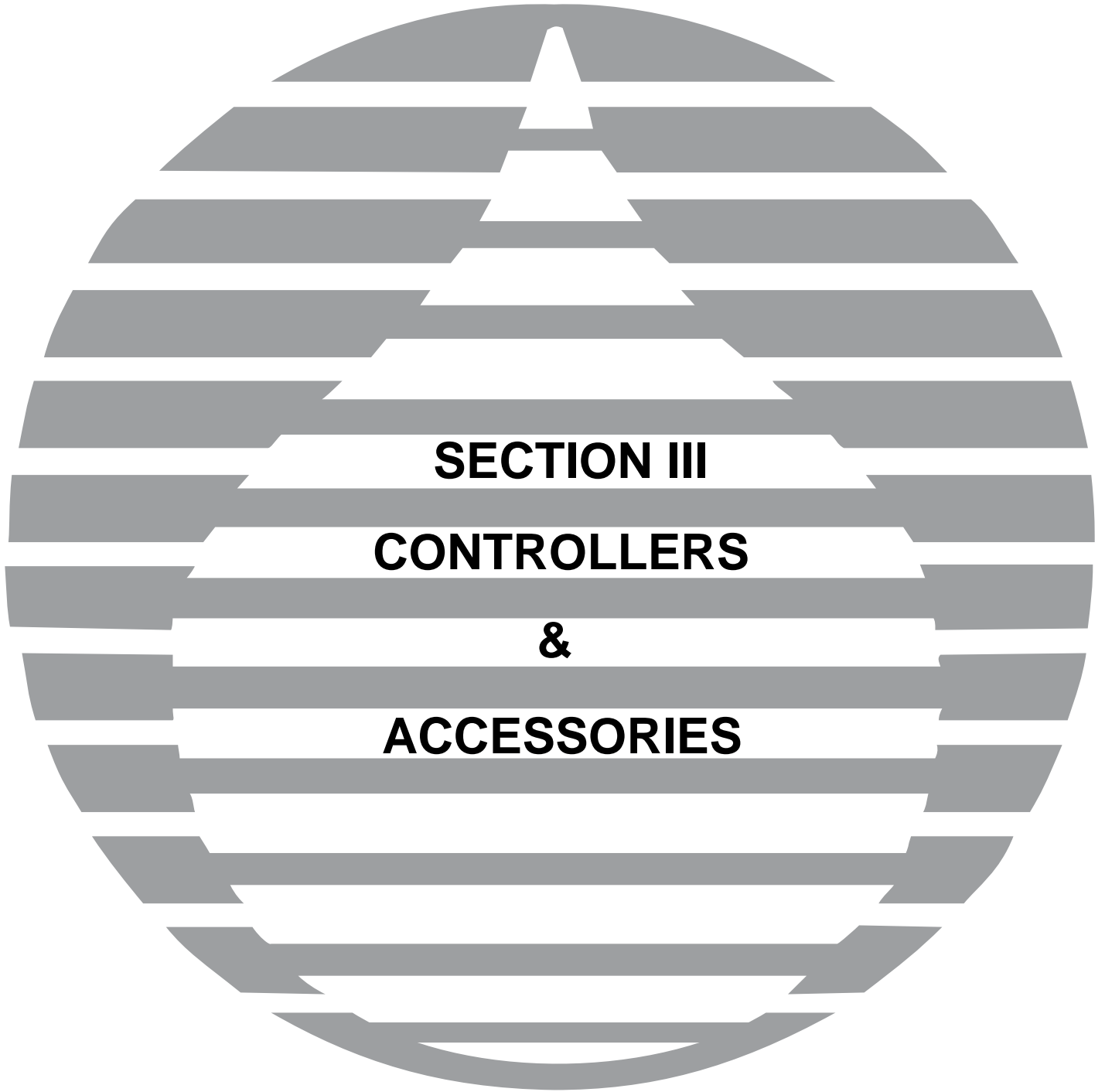

CONTROLLERS

Conductivity

Conductivity

Liquitron™ DC4000 Series					Price
DC4000	Microprocessor-Based, Cooling Tower/boiler conductivity controller with four [4] programmable inhibitor feed options, 4-20 mA (non-isolated) recorder output. 0 - 20,000 µS/cm control range.				\$ 689
	Voltage	Voltage	Frequency	Plug	
	01	115VAC	50-60 HZ	No power cord, PG-9 connectors	\$ -
	02	230VAC	50-60 HZ	No power cord, PG-9 connectors	\$ -
	03	115VAC	50-60 HZ	No power cord, 1/2" NPT Plugs	\$ -
	04	230VAC	50-60 HZ	No power cord, 1/2" NPT plugs	\$ -
	1	115 VAC*	50-60 HZ	USA Plug	\$ -
	2	230 VAC*	50-60 HZ	USA Plug	\$ -
	3	220-240 VAC*	50-60 HZ	DIN Plug	\$ -
	5	240-250 VAC*	50-60 HZ	UK Plug	\$ -
	6	240-250 VAC*	50-60 HZ	AUST/NZ Plug	\$ -
	Probe and Manifold				
	0	No Probe/Manifold			\$ -
	1	Cooling Tower Carbon Probe and 3/4" Fslip Sch 80 PVC Tee with 10 ft (3m) Cable Assembly (Manifold # 34758)			\$ 249
	2	Cooling Tower Carbon Probe and Manifold Assembly with Flow Switch, Sample Valve and 10ft (3m) Cable Assembly (Manifold # 34752)			\$ 446
	3	Boiler Probe Assembly with 1" Cross and 1/2" Conduit Tee (Manifold # 34761)			\$ 358
DC4000 -	01 -	0			

NOTES:

* All options listed with a part number above are available for purchase separately. The price listed with the accessory is the price if purchased separately.

* 115VAC Units are provided with one 6 ft. (2m) grounded power cord and plug, and two [2] 1 ft. (30 cm) output power cords with grounded recepticles for controlled devices.

230VAC Units are provided with 6 ft. (2m) grounded power cords and plug, and throughput connectors for hardwire connection of controlled devices.

A CE approved controller must be requested by adding the prefix "CE". Example: CE-DC4000-X.

For support:



CONTROLLERS

Conductivity

Conductivity

Liquitron™ DC4500 Series						Price	
DC4500	Microprocessor-Based, Cooling Tower conductivity controller with dual biocide, adjustable lockout timer, prebleed, four [4] programmable inhibitor feed options, and 4-20 mA (non-isolated) recorder output. 0 - 20,000 µS /cm control range.					\$ 949	
	Power Supply		Voltage				
	1		115 VAC			\$ -	
	2		220 - 250 VAC			\$ -	
		Voltage	Description	Frequency	Plug		
		0	PG-9 Connectors	50-60 HZ	No Power Cord	\$ -	
		1	115 VAC*	50-60 HZ	USA Plug	\$ -	
		2	230 VAC*	50-60 HZ	USA Plug	\$ -	
		3	220-240 VAC*	50-60 HZ	DIN Plug	\$ -	
		5	240-250 VAC*	50-60 HZ	UK Plug	\$ -	
		6	240-250 VAC*	50-60 HZ	AUST/NZ Plug	\$ -	
		Pump Control Wiring					
		0	No Pump Output Power Cables (Pump Hardwired)				\$ -
		1	Three (3) Pump Output Power Cables (115VAC receptacles)				\$ -
		2	Three (3) Pump Signal Cables (Four [4] Conductor with 4-pin Connector)				\$ -
		3	Three (3) Pump Signal Cables (Five [5] Conductor with 5-pin Connector)				\$ -
	Probe and Manifold						
	0	No Probe/Manifold				\$ -	
	1	Cooling Tower Carbon Probe and 3/4" Fslip Sch 80 PVC Tee with 10 ft (3m) Cable Assembly (Manifold # 34758)				\$ 249	
	2	Cooling Tower Carbon Probe and Manifold Assembly with Flow Switch, Sample Valve and 10ft (3m) Cable Assembly (Manifold # 34752)				\$ 446	
	3	Cooling Tower Carbon Probe and Manifold Assembly with Flow Switch, Sample Valve and 10ft (3m) Cable Assembly (Manifold # 35657) – Includes ¾" FNPT Connections				\$ 447	
DC4500 -	1	0	0	A -	0		

NOTES:

*+ All options listed with a part number above are available for purchase separately. The price listed with the accessory is the price if purchased separately.

* 115VAC Units are provided with one 6 ft. (2m) grounded power cord and plug, and four [4] 1 ft. (30 cm) output power cords with grounded receptacles for controlled devices.

230VAC Units are provided with 6 ft. (2m) grounded power cords and plug, and throughput connectors for hardwire connection of controlled devices.

For support:



CONTROLLERS

Conductivity

Conductivity Controller - Accessories			
DC4500 Part No.	DC4000 Part No.	Description	Price
35659	35659	Carbon Probe & 3/4" NPT Sch 80 PVC Tee	\$ 249.00
34758	34758	Carbon Probe & 3/4" Fslip Sch 80 PVC Tee	\$ 249.00
35657	35657	Carbon Probe & Manifold Assembly, NPT	\$ 447.00
34752	34752	Carbon Probe & Manifold Assembly	\$ 446.00
34659	34659	Carbon Probe & Cable	\$ 222.00
38164	38164	Stainless Steel Probe & Manifold Assembly	\$ 551.00
38166	38166	Stainless Steel Probe and Tee Assembly	\$ 984.00
32623	32623	Carbon Probe with Tee & 4-Pin Connector	\$ 315.00
34565	34565	Flow Switch Assembly with 3/4" Fslip Sch 80 PVC Tee	\$ 174.00
48088	48088	Flow Switch Assembly with 3/4" Fslip Sch 80 PVC Tee w/	\$ 187.00
36130	36130	Flow Switch Assembly with 3/4" NPT Sch 80 PVC Tee	\$ 174.00
36131	36131	Flow Switch Assembly, Threaded	\$ 174.00
37471	37471	Dual Flow Switch Assembly with 3/4" NPT Sch 80 PVC Tee	\$ 234.00
37469	37469	Dual Switch Assembly, Dual Flow Switch	\$ 167.00
37505	37505	Float Assembly (Techtron)	\$ 44.00
37586	37586	Tee, Flow Switch Assembly NPT	\$ 49.00
35674	35674	Tee, Flow Switch Assembly	\$ 15.30
34572	34572	Flow Switch & 3/4" Fslip	\$ 270.00
34746	34746	Sample Valve with 3/4" Fslip Sch 80 PVC Tee (Horizontal	\$ 49.00
34747	34747	Sample Valve with 3/4" Fslip Sch 80 PVC Tee (Vertical	\$ 142.42
34749	34749	Union Kit, PVC (Union & 2 Sleeves)	\$ 23.50
37535-20	37535-20	20 FT Extension Cable Assembly, Carbon Probe	\$ 90.00
37535-50	37535-50	50 FT Extension Cable Assembly, Carbon Probe	\$ 150.00
37535-100	37535-100	100 FT Extension Cable Assembly, Carbon Probe	\$ 240.00
-	34761	Boiler Probe Assembly with 1" Cross & 1/2" Conduit	\$ 358.00

Replacement Parts for Controller Accessories			
DC4500 Part No.	DC4000 Part No.	Description	Price
32829	32829	Clamp, Pipe	\$ 10.10
32838	32838	Pin, Retaining for Tee	\$ 12.00
34541	34541	Standoff, Pipe	\$ 6.10
32383	32383	Tee for 32776 Carbon Probe	\$ 58.00
35660	35660	Tee Assembly, 3/4" NPT PVC (for carbon probe)	\$ 67.30
34668	34668	Tee Assembly, 3/4" Fslip PVC (for carbon probe)	\$ 67.30
-	34759	Boiler Probe	\$ 252.00
-	34760	Cross, 1"	\$ 79.00
-	34796	Conduit Box Assembly	\$ 49.00
-	35058	Nipple, 1/2" Conduit	\$ 4.00
-	35059	Fitting, 1/2" Conduit	\$ 18.00
37435	37435	O-Ring, Union	\$ 22.00
37043	37043	S.S. Probe & Cable	\$ 314.00
35666	35666	Sample Valve Tee Assembly, 3/4" NPT Vertical	\$ 49.00

CONTROLLERS

Conductivity

DC4000 - Boiler Accessories		
DC4000 Part Number	Description	Price
35201	Flow Control Valve 1/2" - 800 psi	\$ 1,106.00
35202	Flow Control Valve 3/4" - 800 psi	\$ 1,322.00
35206	Orifice Union	\$ 145.00
35207	Orifice Union w/Plates (no holes)	\$ 222.00
35208	Orifice Union w/Plates (pre-drilled)	\$ 256.00
35210	Orifice Plates (no holes)	\$ 75.00
35211	Orifice Plates (pre-drilled)	\$ 111.00
35213	Worcester 10-36 Actuator	\$ 1,008.00
35216	Worcester 10-36 Actuator with 1/2" valve	\$ 1,467.00
35217	Worcester 10-36 Actuator with 3/4" valve	\$ 1,559.00
35218	Worcester 10-75 Actuator with 1/2" valve	\$ 1,905.00
35219	Worcester 10-75 Actuator with 3/4" valve	\$ 1,997.00

Conductivity Controller - Spare Parts				
DC5500 Part No.	DC4500 Part No.	DC4000 Part No.	Description	Price
25930	25930	25930	Cap, 4-Pin Jack, Yellow	\$ 2.10
25957-1	25957-1	25957-1	Cord Clamp	\$ 7.00
25990	25990	25990	Connector Assembly	\$ 12.00
36810	36810	36810	Dowel	\$ 1.00
30588	30588	30588	Label, Outside Junction Panel (LMI)	\$ 3.00
30749	30749	30749	Power Cord, 115V - '1' Cord	\$ 50.00
30752	30752	30752	Power Cord, 230V - '3' Cord, DIN	\$ 29.00
30754	30754	30754	Power Cord, 230V - '6' Cord, AUST	\$ 31.20
31571	31571	31571	Clamp, Cord (PG-9)	\$ 6.20
31617	31617	31617	Cover	\$ 30.00
32094	32094	32094	Label, Housing Cover (water drop)	\$ 8.00
32186	32186	32186	Screw, 4-40 x .37	\$ 1.00
32187	32187	32187	Nut, 4-40 Flush	\$ 1.00
32209	32209	32209	Latch	\$ 9.00
32211	32211	32211	Cap, .125 x .38	\$ 2.00
32352	32352	32352	O-Ring, Sponge	\$ 3.60
32395	32395	32395	Screw	\$ 2.00
33566	33566	33566	Solder Lug Terminal	\$ 3.10
33636	33636		4-Pin Cable Assembly, only for DXXX00-XX2	\$ 33.00
34074	34074	34074	Gasket, Foam	\$ 2.80
34088	34088	34088	Cover Utility Box	\$ 17.70
-	-	36525	Front Panel Assembly	\$ 647.00
-	36526	-	Front Panel Assembly	\$ 631.00
34716	34716	34716	Standoff	\$ 5.70
34735	34735	34735	Ground Wire Assembly	\$ 4.20
-	-	34710	I/O Board Assembly	\$ 376.00
35324	35324	-	I/O Board Assembly	\$ 376.00
-	-	34675	Housing, U.S.A.	\$ 91.00
-	-	34931	Label, External Plugs	\$ 8.00
35712	35712	35712	Fuse, 4A, Time Delay	\$ 5.00

CONTROLLERS

pH and ORP

pH / ORP

Liquitron™ DP5000 & DR5000 Series				Price	
DP5000	Microprocessor-Based, pH controller, wall mount, on/off or proportional pump control, limit timers, hi/low alarm, low level and flow switch inputs, custom backlit LCD display.			\$ 1,460	
DR5000	Microprocessor-based ORP controller, wall mount, on/off or proportional pump control, limit timers, hi/low alarm, low level and flow switch inputs, custom backlit LCD display.			\$ 1,460	
	Voltage		Frequency	Plug	
	1	115 VAC*	50/60 Hz	USA Plug	\$ -
	2	230 VAC*	50/60 Hz	USA Plug	\$ -
	3	220-240 VAC*	50/60 Hz	DIN Plug	\$ -
	5	240-250 VAC*	50/60 Hz	UK Plug	\$ -
	6	240-250 VAC*	50/60 Hz	AUST/NZ Plug	\$ -
	Pump Control				
	A	On/Off Output			\$ -
	B	Proportional Output (non-Roytronic pumps)			\$ -
	C	Proportional Output (for Roytronic Series pumps)			\$ -
Recorder Output					
	0	No Probe/Manifold		\$ -	
	1	4-20 mA Recorder Output (isolated) (replacement part 37830 - see note below)		\$ 306	
DP5000 -	1	A -	0		

To complete your DP5000 or DR5000 installation, select either:

1. Submersible probe and cable assembly, or
2. In-line probe, cable assembly, and tee assembly.

See the following page for more details

NOTES:

+ All options listed with a part number above are available for purchase separately. The price listed with the accessory is the price if purchased separately.

* 115VAC & 220 VAC Proportional Units are provided with one [1] 6 ft. (2m) grounded power cord and plug, and two [2] 10 ft. (3 cm) output cables for direct connections to LMI Series "7" and "9" pumps.

115VAC On/Off Units are provided with one 6 ft. (2m) grounded power cord and plug, and two [2] 1 ft (30cm) output power cords with grounded receptacles for pumps.

230VAC Units are provided with 6 ft. (2m) grounded power cords and plug, and throughput connectors for hardwire connection of controlled devices.

For DR Controller support:



For DP Controller support:



CONTROLLERS

pH and ORP

pH / ORP Controller - Accessories

To complete your DP5000 or DR5000 installation, select either

1) submersible probe and cable assembly or

2) in-line probe, cable assembly and tee assembly.

DP5000 Part No.	DR5000 Part No.	Description	Price
32820	-	Flat Surface Combination [pH] Electrode, In-Line PVC Body	\$ 391.00
-	33369	Flat Surface Combination [ORP] Electrode, In-Line PVC Body	\$ 470.00
32821	-	Flat Surface Combination [pH] Electrode, Submersible PVC Body	\$ 391.00
-	33368	Flat Surface Combination [ORP] Electrode, Submersible PVC Body	\$ 470.00
32822	-	Cable Assembly with Temperature Compensation for In-Line Mounting (compatible with Electrode p/n 32819)	\$ 1,548.00
32823	-	Cable Assembly with Temperature Compensation for Submersible Mounting	\$ 448.00
32824	-	Cable Assembly with Temperature Compensation for In-Line Mounting (compatible with Electrode p/n 32820)	\$ 592.00
33370	33370	Cable Assembly, Non-Temperature Compensated, install kit with a 3/4" NPT PVC "T" for In-Line Mounting (Compatible with Electrodes 32819 [pH] or 33367 [ORP])	\$ 238.00
33371	33371	Cable Assembly, Non-Temperature Compensated, install kit with a 3/4" NPT CPVC "T" for In-Line Mounting (Compatible with Electrodes 32820 [pH] or 33369 [ORP])	\$ 353.00
33372	33372	Cable Assembly, Non-Temperature Compensated, for Submersible Mounting (Compatible with Electrodes 32819 & 32821 [pH] or 33367 & 33368 [ORP])	\$ 189.00
34495	-	Cable Assembly with Temperature Compensation for In-Line Mounting (Compatible with Electrode 32819 & 32820 [pH only])	\$ 560.00
34624	34624	Tee Assembly, without TC (F Slip) (Compatible with 32820 electrode [pH] or 33369 electrode [ORP])	\$ 77.50
34625	-	Tee Assembly, with TC (Compatible with 32820 electrode [pH only])	\$ 69.00
34665	34665	Tee Assembly, without TC (Compatible with 32819 electrode [pH] or 33367 electrode [ORP])	\$ 54.00
34666	-	Tee Assembly, with TC (Compatible with 32819 electrode [pH only])	\$ 59.00
35662	-	Tee Assembly, pH with TC, 3/4" NPT	\$ 72.00
33217	33217	Pre-Amp, pH / ORP	\$ 373.00
33286-25	33286-25	25' Cable Assembly (only), for Pre-Amp to Controller	\$ 135.00
33286-50	33286-50	50' Cable Assembly (only), for Pre-Amp to Controller	\$ 192.00
33286-100	33286-100	100' Cable Assembly (only), for Pre-Amp to Controller	\$ 296.00
37830	37830	4-20 mA Circuit Board Assembly	\$ 306.00
34565	34565	Flow Switch Assembly with 3/4" Fslip Sch 80 TVC Tee	\$ 174.00
36130	36130	Flow Switch Assembly with 3/4" NPT Sch 80 PVC Tee	\$ 174.00
34561	34561	Switch Assembly	\$ 109.00
37471	37471	Dual Flow Switch Assembly with 3/4" NPT Sch 80 PVC Tee	\$ 234.00
37469	37469	Dual Flow Switch Assembly	\$ 167.00
37505	37505	Float Assembly (Techtron)	\$ 44.00
37586	37586	Tee, Flow Switch Assembly NPT	\$ 49.00
34746	34746	Sample Valve with 3/4" Fslip Sch 80 TVC Tee (Horizontal Mounting)	\$ 49.00
34747	34747	Sample Valve with 3/4" Fslip Sch 80 TVC Tee (Vertical Mounting)	\$ 142.42
34749	34749	Union Kit, PVC (Union & Two [2] Sleeves)	\$ 23.50
34751	34751	pH/ORP Manifold Assembly (Compatible with 32820 electrode [pH] or 33369 [ORP])	\$ 296.00

CONTROLLERS
pH and ORP

pH / ORP Controller - Spare Parts			
DP5000	DR5000	Description	Price
Part No.	Part No.		
25957-1	25957-1	Cord Clamp	\$ 7.00
28898	28898	Dowel	\$ 2.08
30588	30588	Label	\$ 3.00
30749	30749	Power Cord, 115V - '1' Cord	\$ 50.00
30752	30752	Power Cord, 230V - '3' Cord	\$ 29.00
30754	30754	Power Cord, 230V - '6' Cord	\$ 31.20
31571	31571	Clamp, Cord (PG-9)	\$ 6.20
31576	31576	Standoff	\$ 2.00
32094	32094	Label	\$ 8.00
32186	32186	Screw, 4-40 x .37	\$ 1.00
32187	32187	Nut, 4-40 Flush	\$ 1.00
32209	32209	Latch	\$ 9.00
32211	32211	Cap, .125 x .38	\$ 2.00
32352	32352	O-Ring, Sponge	\$ 3.60
32395	32395	Screw	\$ 2.00
33636	33636	4-Pin Cable Assembly	\$ 33.00
34074	34074	Gasket, Foam	\$ 2.80
34092	-	Switch, Membrane	\$ 98.00
-	34642	Switch, Membrane	\$ 281.25
37524	-	Front Panel Assembly	\$ 924.00
-	37526	Front Panel Assembly	\$ 1,171.00
34200	34200	PCB Assembly	\$ 924.00
34270	34270	I/O Board Assembly	\$ 435.00
34329	34329	BNC Cable Assembly	\$ 72.00
34330	34330	Ribbon Cable Assembly	\$ 35.00
34691	34691	Housing	\$ 92.00
34716	34716	Standoff	\$ 5.70
34930	34930	Label, Terminal Cover	\$ 8.80
37435	37435	O-Ring, Union	\$ 22.00

Controllers

Flow Switch and Time Switch

Flow Switch & Time Switch

Liquitron™ FS5000 Series Flow Switch		Price
FS5000	Flow Switch Controller for use in applications that require flow/no flow control of metering pumps or other devices. Includes flow switch with 3/4" FSLIP fittings, three (3) 115 VAC receptacles on with flow, one (1) 115 VAC service receptacle, and 0.75 GPM flow activation. Power indicator light, flow indicator light and test switch included.	\$ 560

Liquitron™ FS5000 Series Flow Switch		Price
33424	This compact digital time switch is capable of operating two pumps or one pump and one valve for simultaneous operation of feed and bleed. It provides precise timing with the flexibility of daily and/or weekly programming. Simple and fast setting by means of push buttons and display prompts.	\$ 725

We are a proud member of Accudyne Industries, a leading global provider of precision-engineered, process-critical, and technologically advanced flow control systems and industrial compressors. Delivering consistently high levels of performance, we enable customers in the most important industries and harshest environments around the world to accomplish their missions.



LMI® is a registered trademark of Milton Roy, LLC.
LIQUIFRAM™ is a trademark of Milton Roy, LLC.
AUTOPRIME™ is a trademark of Milton Roy, LLC.
PRO PAC™ is a trademark of Milton Roy, LLC.
FASTPRIME™ is a trademark of Milton Roy, LLC.
ROYTRONIC® is a registered trademark of Milton Roy, LLC.
MICROPACE™ is a trademark of Milton Roy, LLC.
© 2001, 2018 Milton Roy, LLC.
info@lmipumps.com
www.lmipumps.com

